

TECH TECH CONTROLLERS

USER MANUAL EU-L-4X WiFi

EN

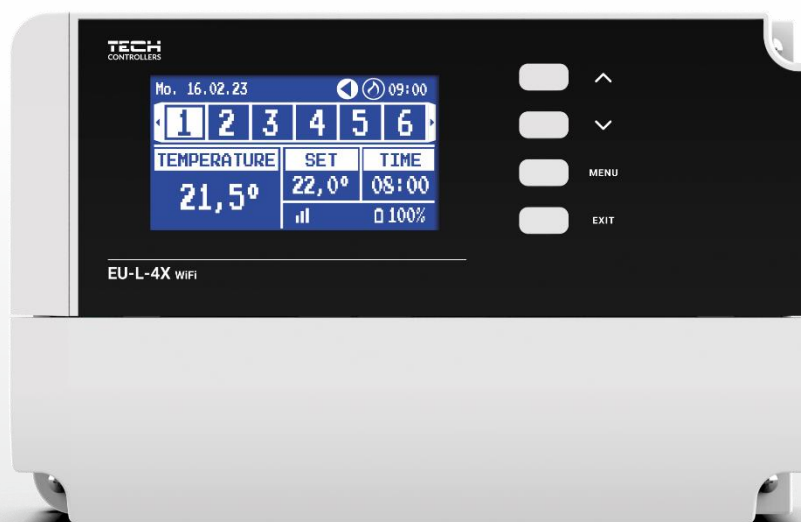

TABLE OF CONTENTS

I.	Safety.....	4
II.	System description	5
III.	Installing the Controller.....	5
IV.	First startup	8
V.	Main screen description.....	9
VI.	Controller functions	11
1.	Operation mode	11
2.	Zones	12
3.	Controller settings.....	13
4.	Fitter's Menu	13
4.1.	Zones	13
4.2.	Additional contacts.....	18
4.3.	Mixing valve.....	18
4.4.	Internet module.....	24
4.5.	Manual mode.....	24
4.6.	External sensor	24
4.7.	Heating stopping.....	24
4.8.	Potential-free contact.....	25
4.9.	Pump.....	25
4.10.	Heating - cooling.....	25
4.11.	Anti-stop settings.....	25
4.12.	Maximum humidity	25
4.13.	Language.....	26
4.14.	Heat pump	26
4.15.	Factory settings.....	26
5.	Service menu	26
6.	Factory settings	26
7.	Software version.....	26
5.	Alarms list.....	26
VII.	Software upgrade.....	28
VIII.	Technical data	29

JG. 02.02.2024

*Images and diagrams contained in the document serve illustrative purposes only.
The manufacturer reserves the right to introduce changes.*

I. SAFETY

Before operating the device, please read the following instructions carefully. Failure to observe the instructions may cause personal injuries and damage the device. Please store this manual for future reference. To avoid unnecessary errors and accidents, make sure that all persons operating the device have thoroughly familiarized themselves with the device operation and its safety functions. Please do not discard the manual and please make sure that it remains with the device when it is transferred. As far as safety of human life, health, and property is concerned, please observe the precautions listed in the operating manual - as the manufacturer will not be liable for any damages caused by negligence.



WARNING

- **Live electric equipment.** Before carrying out any operations related to the power supply (connecting cables, installing the device, etc.), make sure that the device is not connected to the mains!
- Installation should be carried out by a person holding appropriate electrical qualifications!
- Before starting the controller, the ground resistance of electric motors and the insulation resistance of electric wires should be measured.
- The device is not intended for use by children!



CAUTION

- Atmospheric discharges can damage the controller, so during a thunderstorm, switch it off by unplugging the mains plug.
- The controller may not be used contrary to its intended purpose.
- Before and during the heating season, check the technical condition of the cables, also check the installation of the controller and clear away all dust and other soiling.

There could be changes introduced in the products listed in the present manual following its last revision of 02.02.2024. The manufacturer reserves the right to introduce changes in design or deviations from the established colours. Illustrations may contain optional equipment. Printing technology may generate differences in the presented colours.

Care for the natural environment is of paramount importance to us. The awareness that we manufacture electronic devices is linked with our obligation to dispose the used electronic parts and devices in a way that is safe for the environment. Therefore, the company requested and received a registration number issued by the Polish Chief Inspector for Environmental Protection. The symbol of the crossed wheeled bin on the product indicates that the product must not be disposed of with municipal waste. By segregating waste for recycling, we help protect the environment. It remains the user's responsibility to hand over used equipment to a designated collection point for recycling electrical and electronic equipment waste.



II. SYSTEM DESCRIPTION

The EU-L-4X WiFi controller is designed to control the heating device and supports 8 zones (4 radiator and 4 floor heating). It also supports wireless and wired RS-485 (TECH SBUS) communication. Due to the additional EU-ML-4X module, WiFi allows expansion of the installation by an additional 4 floor zones. Its primary function is to maintain the preset temperature in each zone. EU-L-4X WiFi is a device that, together with all peripheral devices (room sensors, room regulators, floor sensors, external sensor, window sensors, thermoelectric actuators), forms the entire, integrated system.

Because of its extensive software, the EU-L-4X WiFi controller can:

- support up to 8 dedicated wired EU-R-12b, EU-R-12s, EU-F-12b, EU-R-X regulators
- support up to 4 the wired EU-C-7p sensors (zones: 1-4)
- support up to 8 several different wireless regulators, e.g. EU-R-8X, EU-R-8b, EU-R-8b Plus, EU-R-8s Plus, EU-F-8z and sensors: EU-C-8r, EU-C-mini, EU-CL-mini
- support EU-C-8f floor temperature sensors
- support EU-C-8z external sensor and weather controls
- support wireless EU-C-2n window sensors (up to 6 pcs per zone)
- allow control of STT-868, STT-869 or EU-G-X wireless actuators (6 pcs per zone)
- allow operation of thermoelectric actuators
- allow operation of the mixing valve – after connecting the EU-i-1, EU-i-1m valve module
- control the heating or cooling device by means of a voltage-free contact
- allow one 230V output to the pump
- provide possibility to set an individual operation schedule for every zone
- allow updating the software via USB port

Updates of the list of devices for expanding the system are provided on an ongoing basis on our website
www.tech-controllers.com

The controller has a built-in Internet module, enabling the user to remotely control the system via the <https://emodul.eu> website or through the emodul application.

III. INSTALLING THE CONTROLLER

The EU-L-4X WiFi controller should only be installed by a properly qualified person!



WARNING

Danger of injury or death due to electric shock on live connections. Before working on the controller, disconnect its power supply and secure it against accidental switching on!

Incorrect wiring may damage the controller.

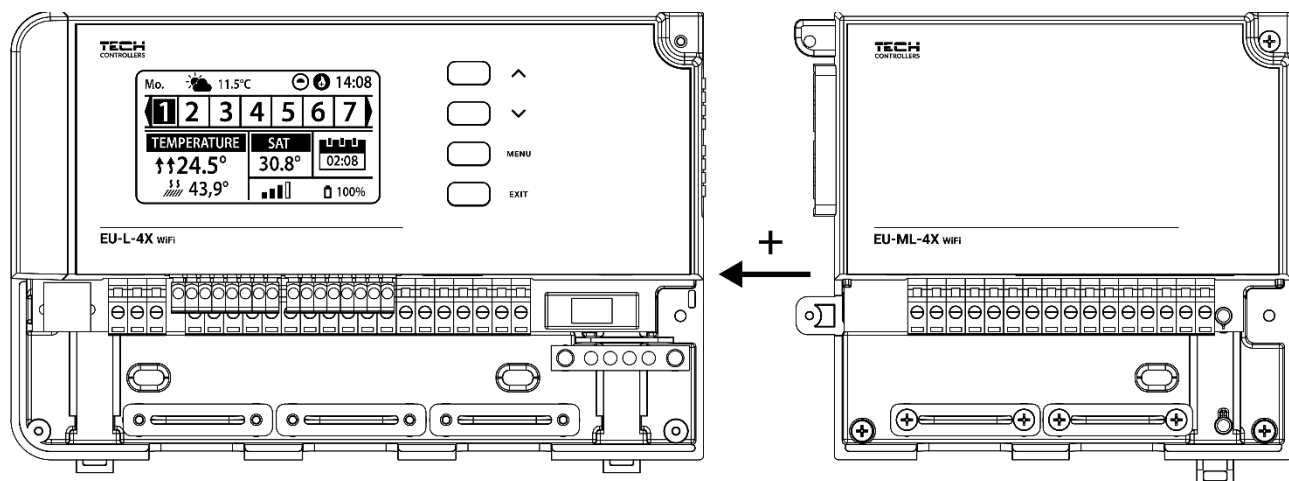

An illustrative diagram explaining how to connect and communicate with the remaining equipment:

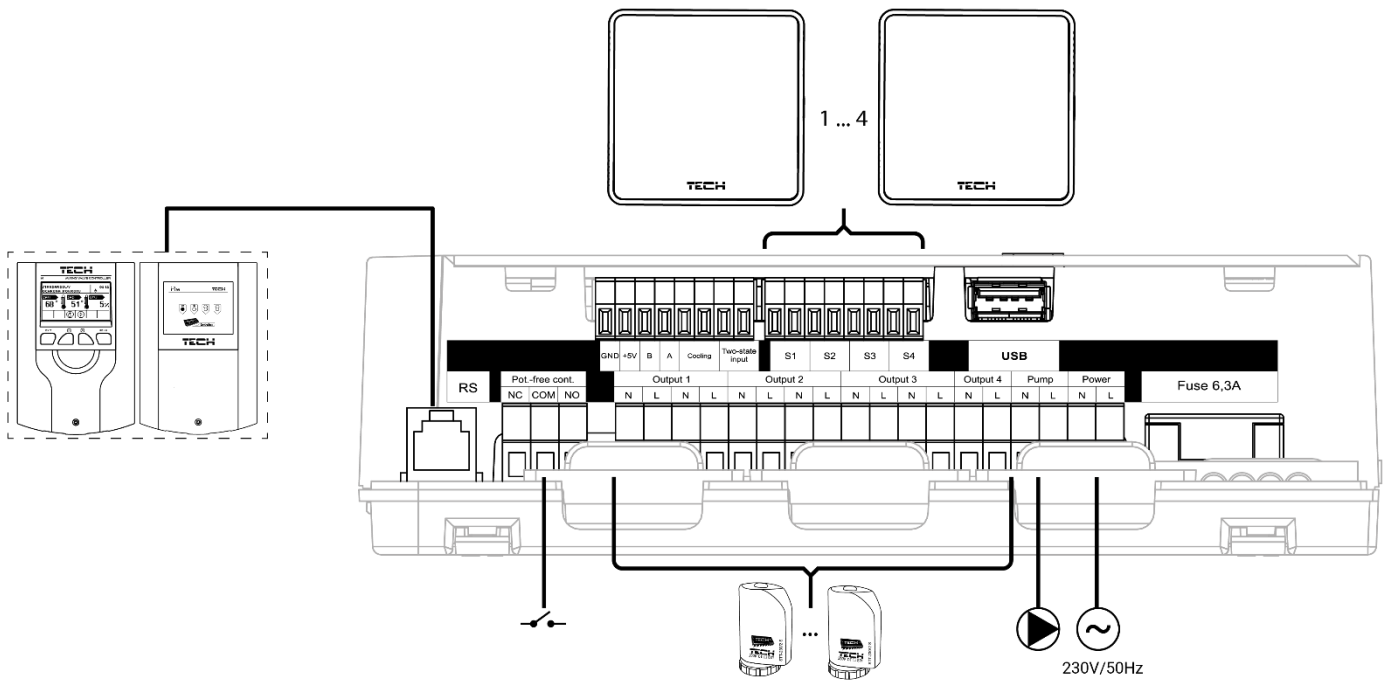
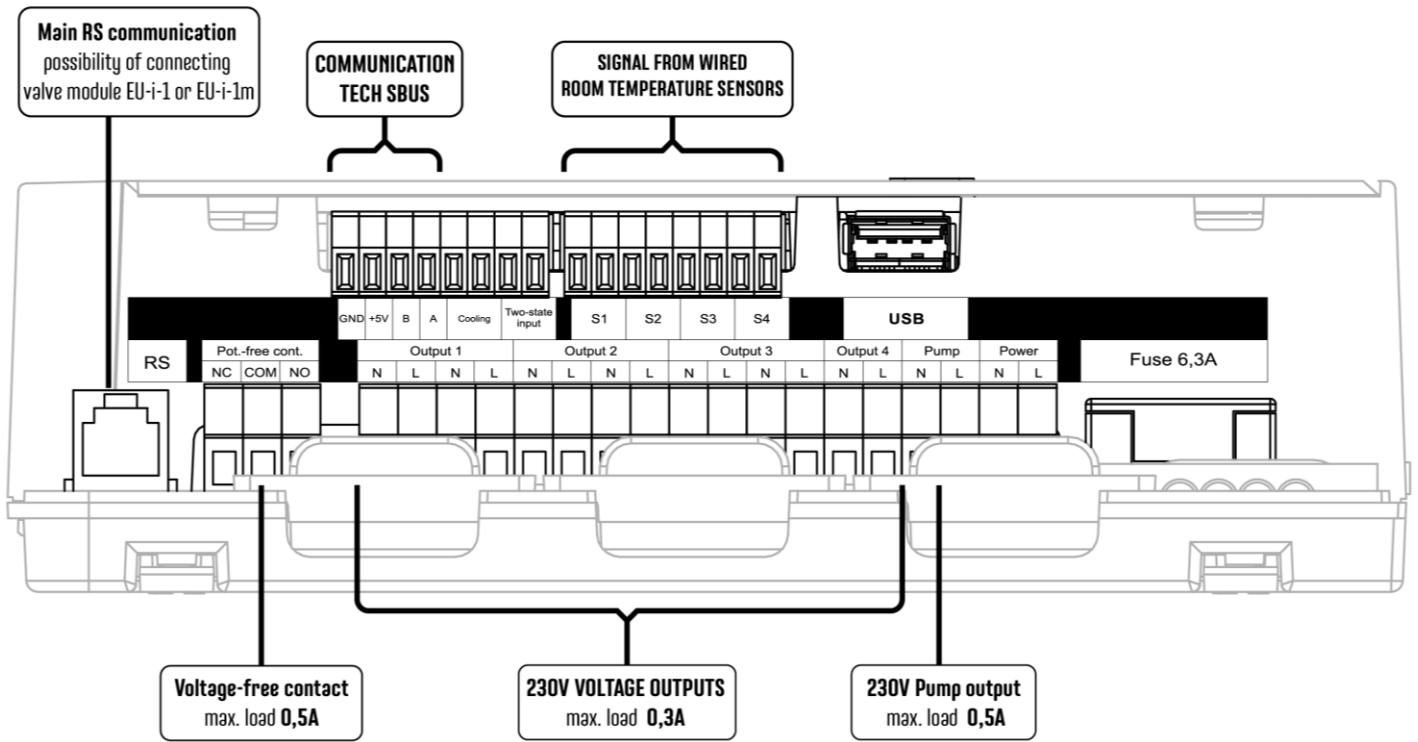

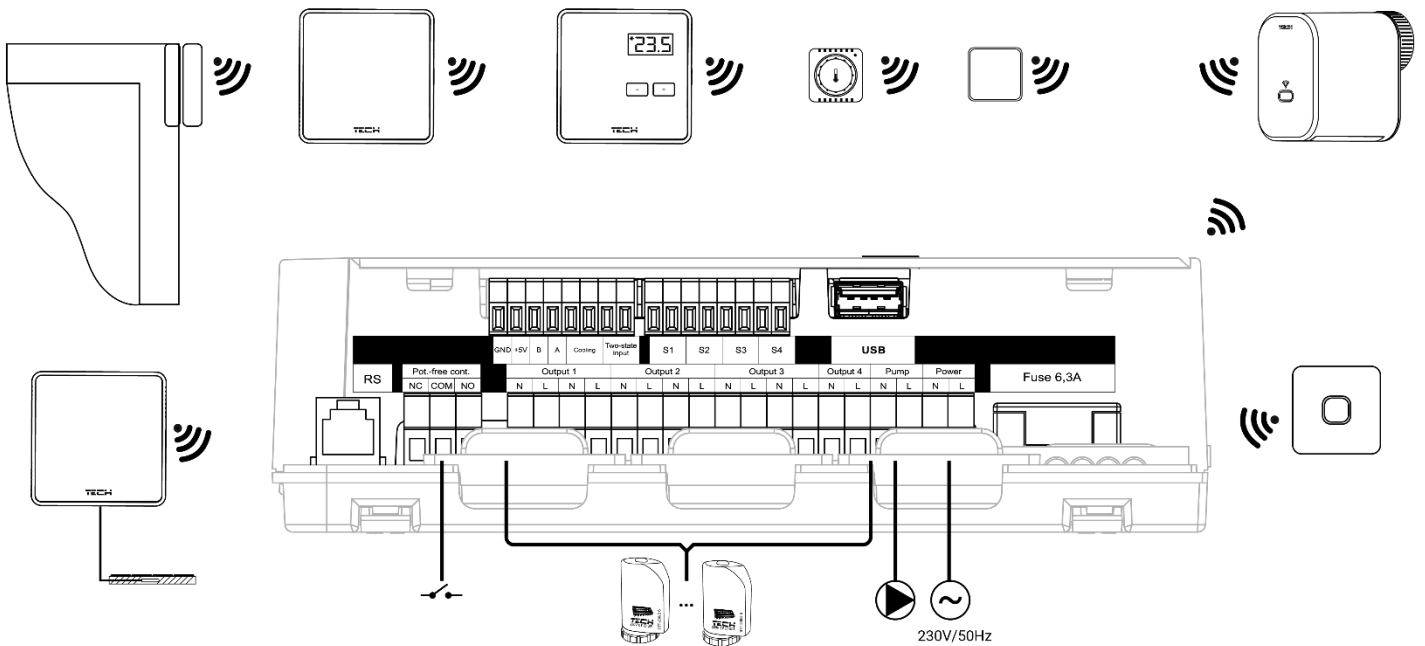

Installation of the electrolytic capacitor

In order to reduce the phenomenon of temperature spikes being read from the zone sensor, a 220uF/25V low impedance electrolytic capacitor, connected in parallel with the sensor cable, should be installed. When installing the capacitor, always pay particular attention to its polarity. The ground of the element marked with a white strip is secured to the right terminal of the sensor connector, as seen from the front of the controller and depicted in attached images. The second terminal of the capacitor is attached to the terminal of the left connector. We found that this solution completely eliminates any potential distortions. However, it is worth noting that the basic principle is to correctly install the wires in order to avoid interference. The wiring should not be routed near sources of electromagnetic field. Should such a situation exist, a filter in the form of a capacitor must be included in the system.

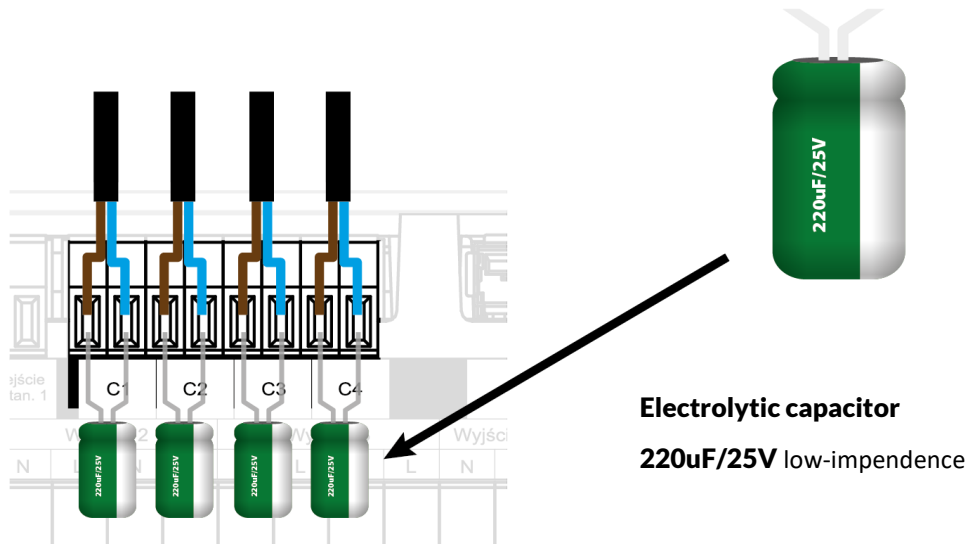

Electrolytic capacitor
220uF/25V low-impedance

WARNING

If pump manufacturer requires an external main switch, power supply fuse or additional residual current device selective for distorted currents it is recommended not to connect pumps directly to pump control outputs.

To avoid damaging to the device, an additional safety circuit must be used between the regulator and the pump. The manufacturer recommends the ZP-01 pump adapter, which must be purchased separately.

Connection between the controller and the room regulators

When connecting room regulators to the controller, the last controller is placed in the termination position by switching the jumper to the ON position.

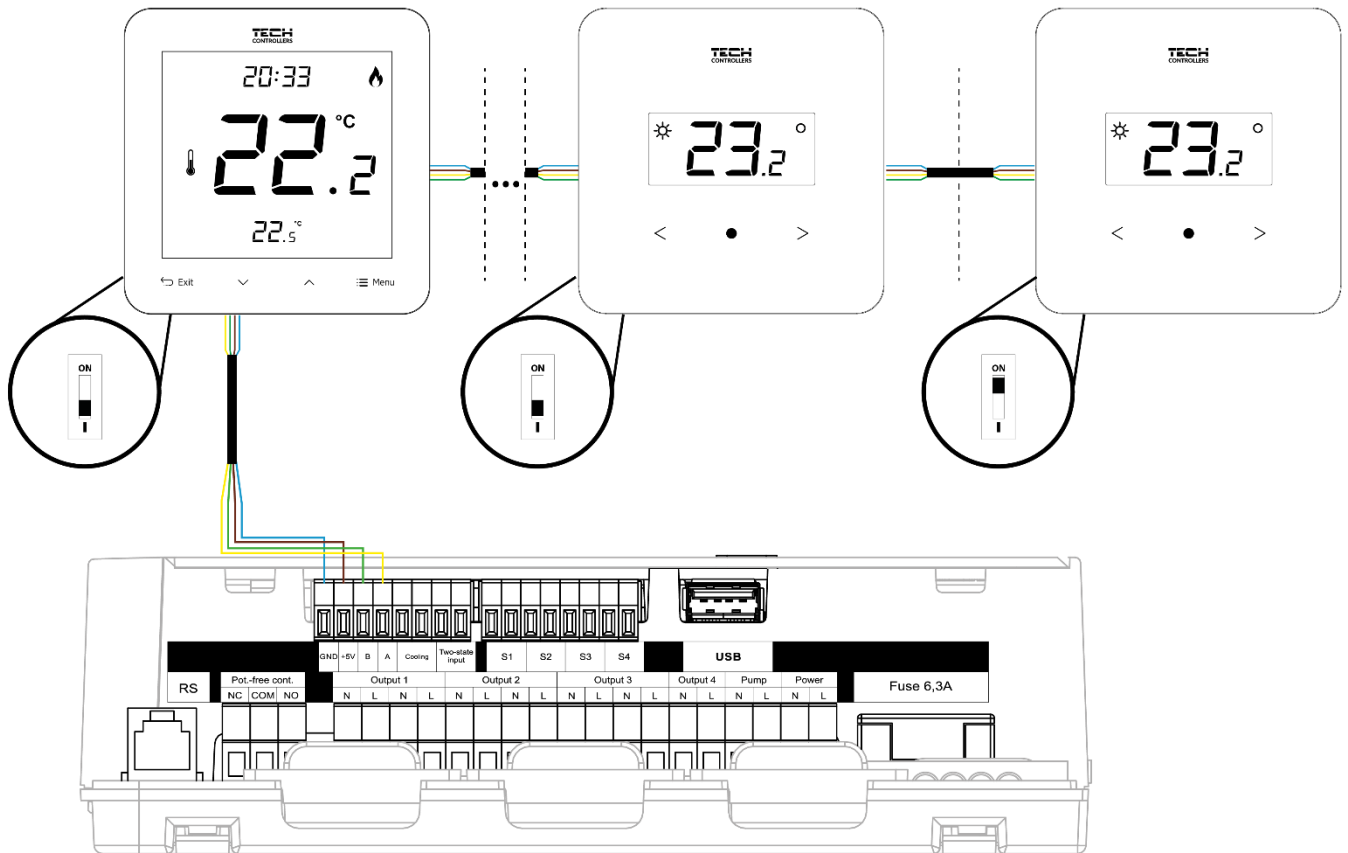

IV. FIRST STARTUP

In order for the controller to operate correctly, the following steps must be followed for the first start-up:

Step 1: Connecting the EU-L-4X WiFi assembly controllers with all the devices it is supposed to control

To connect the wires, remove the controller cover and then connect the wiring – this should be done as described on the connectors and the diagrams in the manual.

Step 2: Switching on the power supply and checking the operation of the connected devices

After connecting all devices, switch on the power supply of the controller.

Using the Manual mode function (**Menu → Fitter's Menu → Manual mode**), check the operation of the individual devices. Using the **✓** and **∧** buttons, select the device and press the MENU button – the device to be checked should switch on. Check all the connected devices in this manner.

Step 3: Setting the current time and date

To set the current date and time, select: **Menu → Controller settings → Time settings**.



CAUTION

Using the web module, the current time can be adjusted from the network automatically.

Step 4. Configuring temperature sensors, room regulators

In order for the EU-L-4X WiFi controller to support a given zone, it must receive information about the current temperature. The simplest way is to use a wired or wireless temperature sensor (e.g. EU-C-7p, EU-C-mini, EU-CL-mini, EU-C-8r). However, if the operator wishes to be able to change the set temperature value directly from the zone, the operator can use general room regulators, e.g. EU-R-8b, EU-R-8z, EU-R-8b Plus or dedicated controllers: EU-R-12b, EU-R-12s e.t.c. To pair the sensor with the controller, select on controller: **Menu** → **Fitter's Menu** → **Zones** → **Zone...** → **Room sensor** → **Sensor selection** and lightly press the registration button on the sensor or controller.

Step 5. Configuring the remaining cooperating devices

The EU-L-4X WiFi controller can also operate with the following devices:

- EU-i-1, EU-i-1m mixing valve modules
- additional contacts, e.g. EU-MW-1 (6 pcs per controller)

After switching on the built-in Internet module, users have the option to control the installation via the Internet via the emodul.eu application. Please refer to the manual of the respective module for configuration details.



CAUTION

If users want to utilize the above devices in their systems, they must be connected and/or registered.

V. MAIN SCREEN DESCRIPTION

The control is carried out using the buttons located next to the display.

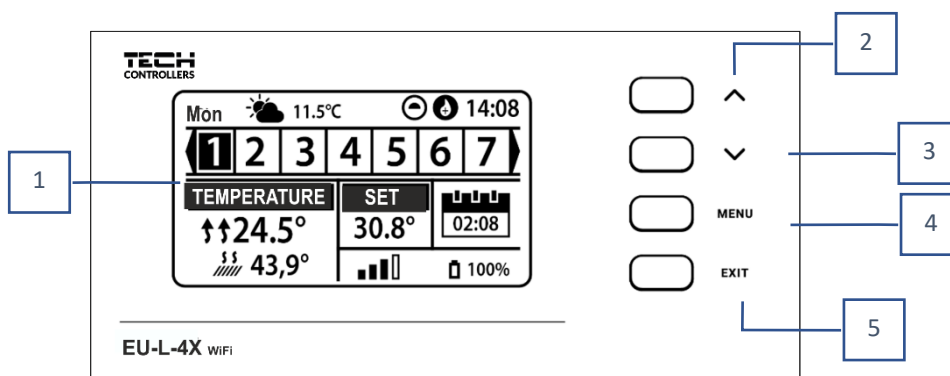

1. Controller display.
2. **^ button** - used to browse the menu functions or increase the value of the edited parameters. This button also switches the operation parameters between the zones.
3. **v button** - used to browse the menu functions or decrease the value of the edited parameters. This button also switches the operation parameters between the zones.
4. **MENU button** - enters the controller menu, confirms the settings.
5. **EXIT button** - exits the controller menu or cancels the settings or toggles the screen view (zones, zone).

Sample screens - ZONES

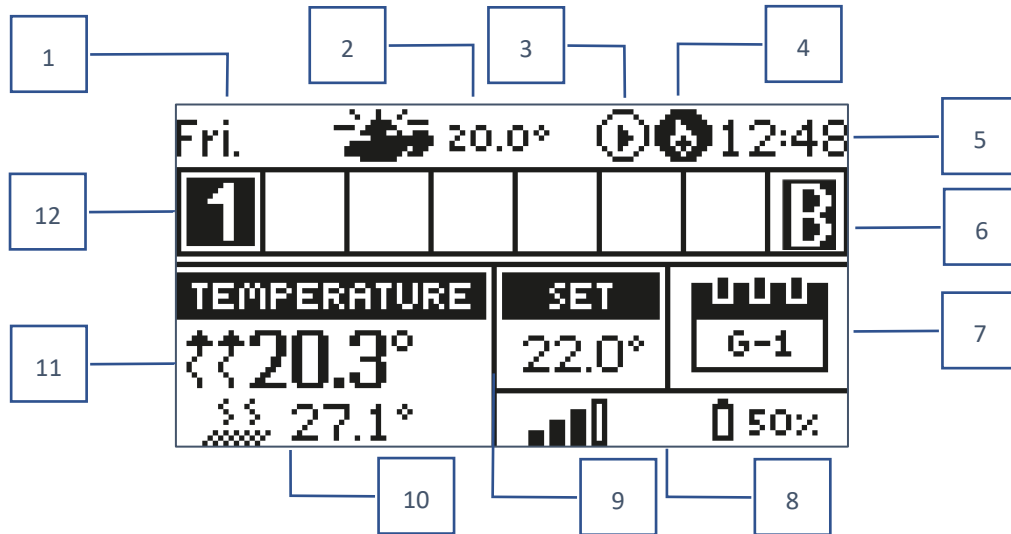

1. Current day of the week
2. Outside temperature
3. Pump ON
4. Activated potential-free contact

	zone heating ON		zone cooling ON
--	-----------------	--	-----------------

5. Current time
6. Active bypass function in the zone – see section VI. 4.14. Heat pump
7. Information about the operation mode/schedule in the respective zone

L	local schedule	CON	constant temperature
G-1....G-5	global schedule 1-5	02:08	time-limited

8. Signal strength and battery status of the room sensor information
9. Preset temperature in a given zone
10. Current floor temperature
11. Current temperature in a given zone

	zone heating		zone cooling
---	--------------	---	--------------

12. Zone information. A visible digit means a connected room sensor exists that provides information about the current temperature in the respective zone. If the zone is currently heating or cooling, depending on the mode, the digit flashes. If an alarm occurs in a given zone, an exclamation mark will be displayed instead of a digit.

To view the current operating parameters of a specific zone, highlight its number using the   buttons.

Sample Screen - ZONE

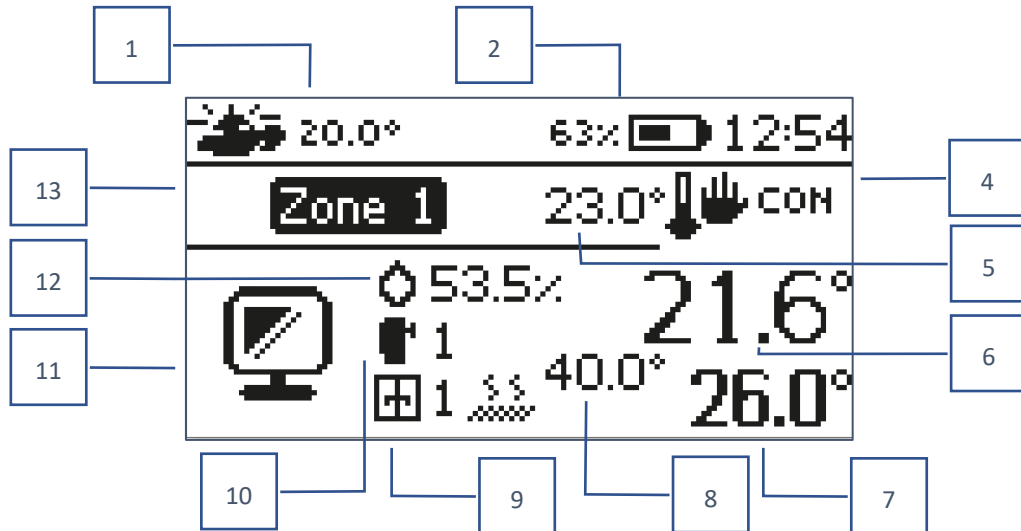

- | | |
|--|---|
| 1. Outside temperature | 8. Maximum floor temperature |
| 2. Battery status | 9. Information on the number of registered window sensors in the zone |
| 3. Current time | 10. Information about the number of registered actuators in the zone |
| 4. Current mode of operation of the displayed zone | 11. Icon of the currently displayed zone |
| 5. The preset temperature of the given zone | 12. Current humidity level in the given zone |
| 6. Current temperature of the given zone | 13. Zone name |
| 7. Current floor temperature | |

VI. CONTROLLER FUNCTIONS

1. OPERATION MODE

This function enables activation of the selected operation mode.

- **Normal mode** – the preset temperature depends on the set schedule
- **Holiday mode** – the set temperature depends on the settings of this mode

Menu → Fitter's menu → Zones → Zone... → Settings → Temperature settings > Holiday mode

- **Economy mode** – the set temperature depends on the settings of this mode

Menu → Fitter's menu → Zones → Zone... → Settings → Temperature settings > Economy mode

- **Comfort mode** – the set temperature depends on the settings of this mode

Menu → Fitter's menu → Zones → Zone... → Settings → Temperature settings > Comfort mode



CAUTION

- Changing the mode to holiday, economy or comfort applies to all zones. In such modes, users can only change the setpoint temperature of the selected mode for a particular zone.
- In operation modes other than normal, users cannot change the set temperature at the room regulator level.

2. ZONES

➤ ON

To display the zone as active on the screen, register a sensor in it (see: Fitter's Menu). The function allows you to disable the zone and hide the parameters from the main screen.

➤ Set temperature

The set temperature in the zone results from the settings of a specific mode of operation in the zone, i.e. the weekly schedule. However, it is possible to by-pass the schedule and set up a separate temperature and temperature duration. After this time, the set temperature in the zone will depend on the previously set mode. On an ongoing basis, the set temperature value and the time until the end of its validity is displayed on the main screen.

CAUTION

 In the event that the duration of a specific setpoint temperature is set to CON, this temperature will be valid for an indefinite period (constant temperature).

➤ Operation mode

Users have the ability to view and change the operation mode settings for the zone.

- **Local Schedule** – for scheduling settings that only apply to one zone
- **Global Schedule 1-5** – for scheduling settings that apply to all zones, where they are active
- **Constant temperature (CON)** – for setting separate set temperature values that will be valid in a given zone permanently, regardless of the time of day
- **Time limit** – for setting a separate temperature that will be valid only for a specific period of time. After this time, the temperature will result from the previously applicable mode (schedule or constant without time limit).

Schedule editing

Menu → Zones → Zone... → Operation mode → Schedule... → Edit

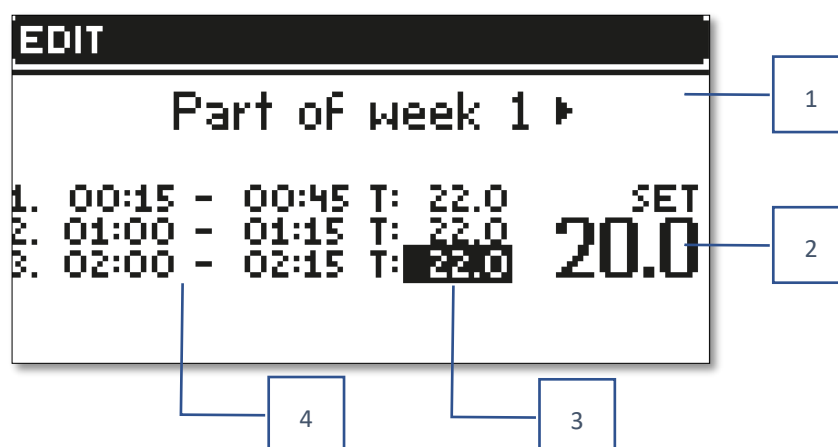

1. Days on which the above settings apply
2. Temperature set outside the time intervals
3. Set temperatures for time intervals
4. Time intervals

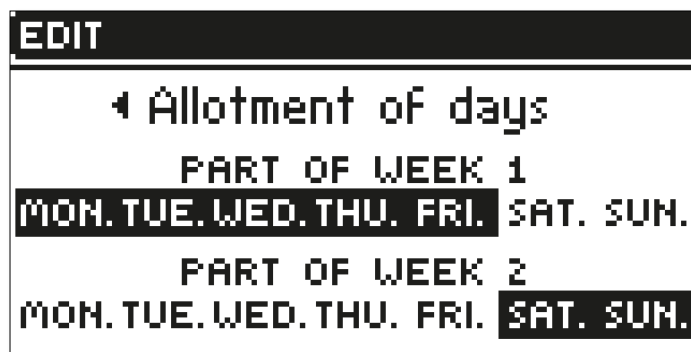

To configure a schedule:

- Use the arrows ∇/\wedge to select the part of the week for which the set schedule will apply (1st part of the week or 2nd part of week).
- Use the MENU button to go to the set temperature settings that will apply outside the time intervals - set it with the arrows, confirm using the MENU button
- Use the MENU button to go to the settings of the time intervals and the set temperature that will apply to the specified time interval, set it using the arrows, confirm with the MENU button
- Proceed to the editing of days that are assigned to the 1st or 2nd part of the week (active days are displayed in white). The settings are confirmed with the MENU button, the arrows navigate between each day

After setting the schedule for all days of the week, press the EXIT button and select the *Confirm* option with the MENU button.



CAUTION

Users can set three different time intervals in a given schedule (with an accuracy of 15 minutes).

3. CONTROLLER SETTINGS

- **Time settings** - the current time and date can be automatically downloaded from the network if the Internet module is connected and the automatic mode is enabled. It is also possible for users to manually set the time and date if the automatic mode does not operate correctly.
- **Screen settings** - This function allows users to customize the display.
- **Sound the buttons** - this option is chosen to enable/disable the sound that will accompany pressing the buttons.

4. FITTER'S MENU

The fitter's menu is the most complex controller menu and enables users to access a wide selection of functions that allow for maximum use of the controller's capabilities.

4.1. ZONES

To activate a zone on the controller display, register/activate a sensor therein and then activate the zone.

4.1.1. ROOM SENSOR

Users can register/enable any type of sensor: NTC wired, RS or wireless.

- **Hysteresis** - adds a tolerance for the room temperature in the range of $0.1 \div 5^\circ\text{C}$, at which there is additional heating/cooling enabled.

Example:

The preset room temperature is 23°C

Hysteresis is 1°C

The room sensor will start to indicate room underheating after the temperature drops to 22°C .

- **Calibration** - Room sensor calibration is carried out during assembly or after a longer period of use of the sensor if the displayed room temperature deviates from the actual one. Adjustment range: from -10°C to +10°C, with a step of 0.1°C.

4.1.2. SET TEMPERATURE

The function is described in the *Menu → Zones* section.

4.1.3. OPERATION MODE

The function is described in the *Menu → Zones* section.

4.1.4. OUTPUTS CONFIGURATION

This option controls the outputs: floor heating pump, potential-free contact and outputs of sensors 1-4 (NTC to control the temperature in the zone or floor sensor to control the floor temperature). Sensor outputs 1-4 are assigned to zones 1-4, respectively.

The type of sensor selected here will appear by default in the option: *Menu → Fitter's menu → Zones → Zones... → Room sensor → Sensor selection* (for temperature sensor) and *Menu → Fitter's Menu → Zones → Zones... → Floor heating → Floor sensor → Sensor selection* (for floor sensor).

The outputs of both sensors are used to register the zone by wire.

The function also allows switching off the pump and the contact in a given zone. Such a zone, despite the need for heating, will not participate in the control when switched off.

4.1.5. SETTINGS

- **Weather control** - the option to turn the weather control on/off.



CAUTION

Weather control functions only if in the in the *Menu → Fitter's menu → External sensor*, the *Weather control* option was checked.

- **Heating** – this function enables/disables the heating function, and allows selection of a schedule that will be valid for the zone during heating, as well as choosing a separate constant temperature.
- **Cooling** - this function enables/disables the cooling function and allows selection of a schedule that will be valid in the zone during cooling, as well as choosing a separate constant temperature.
- **Temperature settings** – this function is used to set the temperature for the three operation modes (Holiday mode, Economy mode, Comfort mode).
- **Optimum start**

Optimum start is an intelligent heating control system. It functions through continuous monitoring of the heating system and employs this information to automatically activate the heating in advance of the time required to reach the set temperatures. This system does not require any involvement on the part of the user and precisely responds to any changes that affect the efficiency of the heating system. If, for example, there are changes made to the installation and the house warms up faster, the optimum start system will identify the change at the next programmed temperature change resulting from the schedule, and in the subsequent cycle it will delay the activation of the heating until the last moment, reducing the time required to reach the preset temperature.

Room temperature -
OPTIMUM START function OFF:

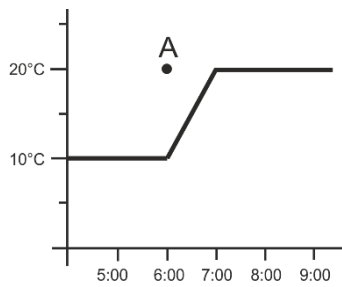

Room temperature -
OPTIMUM START function active:

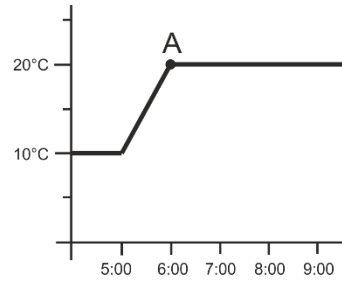

A – programmed moment of changing the economic temperature to the comfortable one

Activating this function will ensure that when the programmed change of the set temperature resulting from the schedule occurs, the current temperature in the room will be close to the desired value.



CAUTION

The optimum start function only functions in the heating mode.

4.1.6. ACTUATORS

➤ **Settings**

- **SIGMA** - the function enables seamless control of the electric actuator. When activating this function, users can set the **minimum and maximum openings of the valve** – this means that the degree of opening and closing of the valve will never exceed these values. In addition, users can adjust the **Range** parameter, which determines at which room temperature the valve will start to close and open.



CAUTION

The Sigma function is only available for STT-868 or STT-869 actuators.

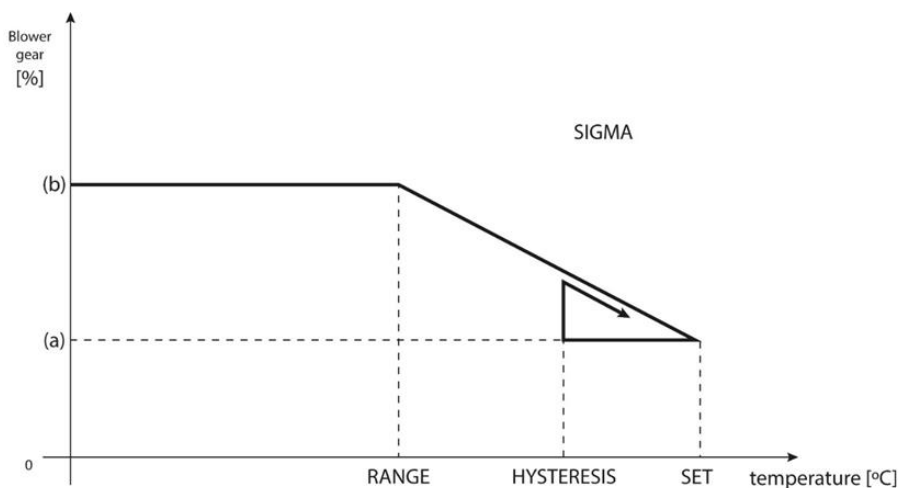

(a) - min. opening
(b) - Actuator opening
ZAD - set temperature

Example:

Zone preset temperature: 23°C

Minimum opening: 30%

Maximum opening: 90%

Range: 5°C

Hysteresis: 2°C

With the above settings, the actuator will start to close once the temperature in the zone reaches 18°C (preset temperature minus the range value). The minimum opening will occur when the zone temperature reaches the set point.

Once the set point is reached, the temperature in the zone will start to drop. When it reaches 21°C (set temperature minus hysteresis value), the actuator will start to open - reaching maximum opening when the temperature in the zone reaches 18°C.

- **Protection** - When this function is selected, the controller checks the temperature. If the set temperature is exceeded by the number of degrees in the *Range* parameter, then all actuators in a given zone will be closed (0% opening). This function only works with the SIGMA function enabled.
 - **Emergency Mode** – The function allows users to set the actuator actuators to open when an alarm occurs in a given zone (sensor failure, communication error).
- **Actuators 1-6** - option enables users to register a wireless actuator. To do this, select *Register* and briefly press the communication button on the actuator. After successful registration, an additional *Information* function appears, where the users can view the actuator parameters, e.g. battery status, range, etc. When selecting this option, it is also possible to delete one or all actuators at the same time.

4.1.7. WINDOW SENSORS

- **Settings**
- **ON** - the function enables the activation of window sensors in a given zone (window sensor registration required).
 - **Delay Time** - This function allows users to set the delay time. After the preset delay time, the main controller responds to the opening of the window and blocks heating or cooling in the respective zone.

Example: The delay time is set to 10 minutes. Once the window is opened, the sensor sends information to the main controller about the window being opened. The sensor confirms the current state of the window from time to time. If after the delay time (10 minutes) the window remains open, the main controller will close the valve actuators and switch off the overheating of the zone.



CAUTION

If the delay time is set to 0, then the signal to the actuator to close will be transmitted immediately.

- **Wireless** – option to register window sensors (1-6 pcs per zone). To do this, select *Register* and briefly press the communication button on the sensor. After successful registration, an additional *Information* function appears, where the users can view the sensor parameters, e.g. battery status, range, etc. It is also possible to delete a given sensor or all at the same time.

4.1.8. FLOOR HEATING

➤ Floor Sensor

- **Sensor Selection** - This function is used to enable (wired) or register (wireless) floor sensor. In the case of a wireless sensor, register occurs by additionally pressing the communication button on the sensor.
- **Hysteresis** - adds a tolerance for the room temperature in the range of $0.1 \div 5^{\circ}\text{C}$, at which the additional heating/cooling is enabled.

Example:

The maximum floor temperature is 45°C

Hysteresis is 2°C

The controller will deactivate the contact after 45°C is exceeded at the floor sensor. If the temperature starts to drop, the contact will be switched back on again after the temperature at the floor sensor drops to 43°C (unless the set room temperature has been reached).

- **Calibration** - Floor sensor calibration is carried out during assembly or after a longer period of use of the sensor, if the displayed floor temperature deviates from the actual. Adjustment ranges from -10°C to $+10^{\circ}\text{C}$, with a step of 0.1°C .



CAUTION

The floor sensor is not used during the cooling mode.

➤ Operation mode

- **OFF** – Selecting this option disables the floor heating mode, i.e. *Floor Protection* nor *Comfort Mode* are not active
- **Floor Protection** – This function is used to keep the floor temperature below the set maximum temperature to protect the system from overheating. When the temperature rises to the set maximum temperature, the reheating of the zone will be switched off.
- **Comfort mode** – This function is used to maintain a comfortable floor temperature, i.e. the controller will monitor the current temperature. When the temperature rises to the set maximum temperature, the zone heating will be switched off to protect the system from overheating. When the floor temperature drops below the set minimum temperature, the zone reheat will be switched back on.

➤ Min. temperature

The function is used to set the minimum temperature to protect the floor from cooling down. When the floor temperature drops below the set minimum temperature, the zone reheat will be switched back on. This function is only available upon selecting *Comfort Mode*.

➤ Max. temperature

The maximum floor temperature is the floor temperature threshold above which the controller will switch off the heating regardless of the current room temperature. This function protects the installation from overheating.

4.2. ADDITIONAL CONTACTS

The function allows users enter additional contacts. First of all, it is necessary to register such a contact (1-6 pcs.). To do this, select the **Registration** option and briefly press the communication button on the device, e.g. EU-MW-1.

After registering and switching on the device, the following functions will appear:

- **Information** – provides information about the status, operation mode and contact range (displayed on the controller screen)
- **ON** - enables/disables contact operation
- **Operation mode** – enables activation of the selected contact operation mode
- **Time mode** – allows setting the contact operation time for a specific time
Users can change the contact status by selecting/deselecting the **Active** option and then setting the **Duration** of this mode
- **Constant mode** – allows setting the contact to operate permanently; it is possible to change the contact status by selecting/deselecting the **Active** option.
- **Relays** – the contact works according to the zones to which it has been assigned
- **Dehumidification** – if the **Maximum Humidity** is exceeded in a zone, this option allows start-up of the air dehumidifier
- **Schedule settings** – allows users to set a separate contact operation schedule (regardless of the status of the controller zones).



CAUTION

The **Dehumidification** function operates only in the **Cooling** operation mode.

- **Delete** – used to delete the selected contact

4.3. MIXING VALVE

The EU-L-4X WiFi controller can operate an additional valve using a valve module (e.g. the EU-i-1m). This valve has RS communication, but it is necessary to carry out the registration process, which will require users to quote the module number located in the rear of its housing, or in the software information screen). After correct registration, individual parameters of the auxiliary valve can be set-up.

- **Information** - allows viewing the valve parameters status.
- **Register** - After entering the code on the back of the valve or in the **Menu → Software Information**, users can register the valve with the main controller.
- **Manual mode** – users have the ability to manually stop the valve operation, open/close the valve and switch the pump on and off in order to control the correct operation of the devices
- **Version** - displays the valve software version number. This information is necessary when contacting the service.
- **Valve removal** - used to completely delete information about a selected valve and its operation from the system. The function is applied, for example, when removing the valve or replacing the module (it is then necessary to re-register the new module).
- **ON** – temporarily enables/ disables valve operation
- **Valve set temperature** – for establishing valve set temperature
- **Summer mode** –switching to summer mode closes the valve to avoid unnecessary heating of the house. If the boiler temperature is too high (enabled boiler protection is required), the valve will be opened in emergency mode. This mode is not active in **Return protection** mode.

- **Calibration** - This function can be used to calibrate the built-in valve, e.g. after prolonged use. During calibration, the valve is set to a safe position, i.e. for the CH valve and *Return protection* types - to fully open position, and for floor valve and *Cooling* types - to closed position.
- **Single stroke** - This is the maximum single stroke (opening or closing) that the valve can perform during single temperature sampling. If the temperature is close to the set point, this stroke is calculated on the basis of the *Proportionality coefficient* parameter. Herein, the smaller the single stroke, the more precisely the set temperature can be reached, but the set temperature is reached over a longer period of time.
- **Minimum opening** - A parameter that specifies the smallest degree of valve opening in percent. This parameter enables users to leave the valve slightly open to maintain a minimum flow.

CAUTION



If the minimum opening of the valve is set to 0% (complete closing), the pump will not operate when the valve is closed.

- **Opening time** - A parameter that specifies the time it takes the valve actuator to open the valve from 0% to 100%. This time should be selected to match that of the valve actuator (as indicated on its nameplate).
- **Measurement pause** - This parameter determines the frequency of measuring (control) of water temperature downstream of the CH installation valve. If the sensor indicates a temperature change (deviation from the set point), then the solenoid valve will open or close by the preset value to return to the preset temperature.
- **Valve Hysteresis** - This option is used to set the valve setpoint temperature hysteresis. This is the difference between the preset temperature and the temperature at which the valve will start to close or open.

Example: Valve preset temperature: 50°C

Hysteresis: 2°C

Valve stop: 50°C

Valve opening: 48°C

Valve closing: 52°C

When the set temperature is 50°C and the hysteresis is 2°C, the valve will stop in one position when the temperature reaches 50°C, when the temperature drops to 48°C it will start to open and when it reaches 52°C the valve will start to close in order to lower the temperature.

- **Valve type** – enables users to select the following valve types:
 - **CH valve** – for controlling the temperature in the CH circuit by using the valve sensor. The valve sensor must be placed downstream of the mixing valve on the supply pipe.
 - **Floor valve** - for controlling the temperature by using the underfloor heating circuit settings. The floor type protects the floor system against excessive temperatures. If the type of valve is set as CH and it is connected to the floor system, it may lead to floor system damage.
 - **Return protection** - for controlling the temperature at the return of the installation through the use of the return sensor. Only return and boiler sensors are active in this type of valve, and the valve sensor is not connected to the controller. In this configuration, the valve protects the boiler's return from cold temperature as a priority, and if the *Boiler protection* function is selected, it also protects the boiler from overheating. If the valve is closed (0% open), the water flows only in a shortened circuit, while the full opening of the valve (100%) means that the shortened circuit is closed and the water flows through the entire central heating system.



CAUTION

If the **Boiler Protection** is off, the CH temperature will not affect the opening of the valve. In extreme cases, the boiler may overheat, so it is recommended to configure the boiler protection settings. For this type of valve, refer to the **Return Protection Screen**.

- **Cooling** - for controlling the temperature of the cooling system (the valve opens when the set temperature is lower than the temperature of the valve sensor). **Boiler protection and Return protection** do not function when this type of valve is selected. This type of valve operates despite the active **Summer mode**, while the pump operates via the selected shutdown threshold. This type of valve has a separate heating curve as a function of the **Weather sensor**.
- **Opening in CH calibration** – When this function is enabled, the valve begins its calibration from the opening phase. This function is only available when the valve type is set as a **CH Valve**.
- **Floor heating - summer** – This function is only enabled after selecting the valve type as **Floor Valve**. When this function is activated, the floor valve will operate in the **Summer Mode**.
- **Weather control** – For the weather function to operate correctly, the external sensor **cannot be positioned in an location that is not exposed to atmospheric influences**. The **Weather sensor** function in the controller menu is switched on after installing and connecting the sensor.



CAUTION

This setting is not available in the **Cooling** and **Return Protection** Modes.

Heating curve - this is the curve according to which the set temperature of the controller is determined on the basis of the external temperature. In order for the valve to operate properly, the set temperature (downstream the valve) is set for four intermediate external temperatures: -20°C, -10°C, 0°C and 10°C. There is a separate heating curve for the **Cooling** mode, and this is set for intermediate outdoor temperatures of: 10°C, 20°C, 30°C, 40°C.

- **Room regulator**
 - **Controller type**
 - **Control without room regulator** - This option should be selected if the room regulator is to affect the operation of the valve.
 - **RS regulator decrease** – This option is checked if the valve is to be controlled by a room regulator equipped with RS communication. When this function is chosen, the controller will operate according to the **Room reg. temp. lower** parameter.
 - **RS regulator proportional** - When this controller is chosen, the current boiler and valve temperatures can be viewed. With this function checked, the controller will operate according to the **Room Temperature Difference** and **Setpoint Temperature Change** parameters.
 - **Standard room regulator** - this option is selected if the valve is to be controlled by a two-state controller (not equipped with RS communication). When this function is chosen, the controller will operate according to the **Room reg. temp. lower** parameter.
 - **Room reg. temp. lower** - In this setting, the value by which the valve will lower its set temperature once the temperature set in the room regulator is reached (room heating) is selected.



CAUTION

This parameter applies to the **Standard room regulator** and **RS regulator decrease** functions.

- **Room temperature difference** - This setting determines the unit change in the current room temperature (to the nearest 0.1°C) at which a specific change in the set temperature of the valve will occur.

- **Change of the pre-set temperature**- This setting determines how many degrees the valve temperature will increase or decrease with a unit change in room temperature (see: *Room temperature difference*). This function is only active with the RS room regulator and is closely related to the *Room temperature difference* parameter.

Example: Room temperature difference: 0.5°C
 Valve set temperature change: 1°C
 Valve set temperature: 40°C
 Room regulator set temperature: 23°C

If the room temperature rises to 23.5°C (by 0.5°C above the set room temperature), the valve closes to the 39°C preset (by 1°C).



CAUTION

The parameter applies to the *RS regulator proportional* function.

- **Room regulator function** - In this function, it is necessary to set whether the valve will close (*Closing*) or the temperature will lower (*Lowering the room temperature*) once it is heated.
- **Proportionality coefficient** – The proportionality coefficient is used to determine the valve stroke: the closer to the set temperature, the smaller the stroke. If this coefficient is high, the valve will reach a similar opening faster, but it will be less precise.
 The percentage of the unit opening is calculated using the following formula:

$$(\text{set temperature} - \text{sensor temp.}) \times (\text{proportionality coefficient}/10)$$

- **Maximum floor temperature**– This function specifies the maximum temperature that the valve sensor can reach (if Floor valve is selected). When this value is reached, the valve closes, switches off the pump and a warning regarding overheating of the floor appears on the main screen of the controller.



CAUTION

Only visible if the valve type is set to *Floor valve*.

- **Opening direction** – If, after connecting the valve to the controller, it turns out that it was supposed to be connected in the opposite direction, it is not necessary to switch the supply lines, but it is possible to change the opening direction of the valve by selecting the selected direction: Right or Left.
- **Sensor Selection** – This option applies to the return sensor and the external sensor and allows users to determine whether the additional valve operation should take into account the *Own sensors* of the valve module or the *Sensors of the main controller*. (Only in Slave Mode).
- **CH sensor selection** – This option applies to the CH sensor and allows users to determine whether the function of the auxiliary valve should take into account the *Own sensor* of the valve module or the *Main controller sensor*. (Only in slave mode).
- **Boiler protection** – Protection against excessive CH temperature is intended to prevent dangerous increase of boiler temperature. Users can set the maximum permissible boiler temperature. In the event of a dangerous temperature rise, the valve will begin to open to cool the boiler down. Users can also set the maximum permissible CH temperature, after which the valve will open (Note: should be set by only a qualified individual).



CAUTION

The function is not active for the *Cooling* and *Floor* valve types.

- **Return protection** – This function enables boiler protection against too cold water returning from the main circuit - which could cause low temperature corrosion of the boiler. The return protection works in such a way that when the temperature is too low, the valve closes until the shortened circuit of the boiler reaches the required temperature.



CAUTION

The function does not appear for the valve type *Cooling*.

➤ Valve pump

- **Pump operation modes** – the function allows users to select the pump operation mode:
 - **Always ON** - pump runs at all times regardless of temperature
 - **Always OFF** - the pump is switched off permanently and the controller only controls the operation of the valve
 - **Above the threshold** - the pump turns on above the set switching temperature. If the pump is to be switched on above the threshold, the threshold pump switching temperature must also be set. The value from the CH sensor is taken into account.
- **Pumps switch on temp.**- This option applies to the pump operation above the threshold. The valve pump will switch on when the boiler sensor reaches the pump switching temperature.
- **Pump anti-stop**- When enabled, the valve pump will operate once every 10 days for 2 minutes. This prevents water from fouling the installation outside the heating season.
- **Closing below temperature threshold** - When this function is activated (check the ON option), the valve will remain closed until the boiler sensor reaches the pump switching temperature.



CAUTION

If the additional valve module is an i-1 model, the anti-stop functions of the pumps and the closure below the threshold can be set directly from the sub-menu of that module.



- **Valve pump room regulator**- Option whereby the room regulator switches the pump off once heated.
 - **Only pump**- When enabled, the controller controls only the pump and the valve is not controlled.
- **External sensor calibration** – This function is used to adjust the external sensor, it is done during installation or after prolonged use of the sensor if the displayed external temperature deviates from the actual one. Users can specify the correction value that is to be applied (adjustment range: -10 to +10°C).
- **Valve closing** – Parameter in which the behaviour of the valve in the CH mode is set after it is switched off. ‘Enabling’ this option closes the valve, while ‘disabling’ opens it.
- **Valve Weekly control** – The weekly function allows users to program deviations of the valve set temperature on particular days of the week at specific times. The temperature deviations set are in the range of +/-10°C. To enable weekly control, select and check *Mode 1* or *Mode 2*. Detailed settings of these modes can be found in the following sections of the submenu: *Set Mode 1* and *Set Mode 2*.



CAUTION

For the correct operation of this function, it is necessary to set the current date and time.

MODE 1 - in this mode it is possible to program deviations of the set temperature for **each day of the week separately**. To do this:

- Select the option: *Set Mode 1*
- Select the day of the week for which the change in temperature settings is wanted
- Use the  buttons to select the time for which the change the temperature is wanted and confirm the selection by pressing the MENU button.
- The options then appear at the bottom, select CHANGE by pressing the MENU button when it is highlighted in white.
- Decrease or increase the temperature by the selected value and confirm.
- If the same change is to be applied to the neighbouring hours, press the MENU button on the selected setting, and after the option appears at the bottom of the screen, select COPY and copy the setting to the subsequent or previous hour using the  buttons. Confirm the settings by pressing MENU.

Example:

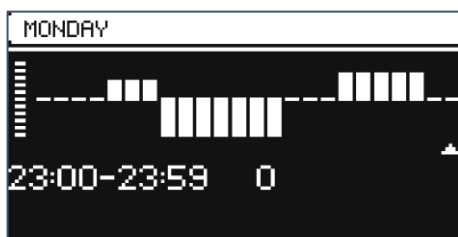

	Time	Temperature - Set Weekly Control
Monday		
PRESET	4 ⁰⁰ - 7 ⁰⁰	+5°C
	7 ⁰⁰ - 14 ⁰⁰	-10°C
	17 ⁰⁰ - 22 ⁰⁰	+7°C

In this case, if the temperature set on the valve is 50°C, on Mondays, from 4⁰⁰ to 7⁰⁰ hours, the temperature set on the valve will increase by 5°C, or to 55°C, while in the hours from 7⁰⁰ to 14⁰⁰, it will decrease by 10°C, so it will be 40°C, and between 17⁰⁰ and 22⁰⁰ it will increase to 57°C.

MODE 2 - in this mode, it is possible to program the temperature deviations in detail for all **working days** (Monday – Friday) and for the **weekend** (Saturday – Sunday). To do this:

- Select the option: *Set Mode 2*
- Select the part of the week for which change in the temperature settings is wanted
- The further procedure is the same as in *Mode 1*

Example:



	Time	Temperature - Set Weekly Control
Monday - Friday		
PRESET	4 ⁰⁰ - 7 ⁰⁰	+5°C
	7 ⁰⁰ - 14 ⁰⁰	-10°C
	17 ⁰⁰ - 22 ⁰⁰	+7°C
Saturday - Sunday		
PRESET	6 ⁰⁰ - 9 ⁰⁰	+5°C
	17 ⁰⁰ - 22 ⁰⁰	+7°C

In this case, if the temperature set on the valve is 50°C Monday to Friday, from 4⁰⁰ to 7⁰⁰ - the temperature on the valve will increase by 5°C, or to 55°C, and in the hours from 7⁰⁰ to 14⁰⁰ - it will decrease by 10°C, so it will be 40°C, while between 17⁰⁰ and 22⁰⁰ - it will increase to 57°C.

During the weekend, from 6⁰⁰ to 9⁰⁰ hours - the temperature on the valve will rise by 5°C, that is to 55°C, and between 17⁰⁰ and 22⁰⁰ - it will rise to 57°C.

- **Factory settings** – This parameter generates a return to the settings of a given valve saved by the manufacturer. Restoring the factory settings changes the valve type to a CH valve.

4.4. INTERNET MODULE

The Internet module is a device that allows remote control of the installation. Users can control the operation of various devices and change some parameters via the emodul.eu application.

The device has a built-in Internet module. After switching on the Internet module and selecting the DHCP option, the controller will automatically retrieve through the local network the parameters of: IP address, IP mask, Gateway address and DNS address.

Required network settings

In order for the Internet module to operate correctly, it is required to connect the module to a network with a DHCP server and an open port 2000.

Once the Internet module is properly connected to the network, go to the module settings menu (in the master controller). If the network does not have a DHCP server, the Internet module must be configured by its administrator by entering the appropriate parameters (DHCP, IP Address, Gateway Address, Subnet Mask, DNS Address).

1. Go to the settings menu of the Internet module.
2. Select the "ON" option
3. Then check if the "DHCP" option is checked.
4. Enter "WIFI Selection"
5. Then select the WIFI network and enter its password.
6. Wait for a moment (ca. 1min) and check if the IP address has been assigned. Go to the "IP Address" tab and check if the value is different than 0.0.0.0/ -.-.-. .
 - a. If the value still indicates 0.0.0.0 / -.-.-.-, check the network settings or the Ethernet connection between the Internet module and the device.
7. After correctly assigning the IP address, register the module to generate the code that is required to assign it to an application account.

4.5. MANUAL MODE

This function allows users to control the operation of individual devices. Users can manually switch on each of the devices: pump, potential-free contact and individual valve actuators. It is recommended to use manual mode to check the correct operation of the connected devices at the first start-up.

4.6. EXTERNAL SENSOR



CAUTION

This function is only available when a EU-C-8zr external sensor has been registered in the EU-L-4X WiFi controller.

Registering the external sensor allows users to switch on the weather control.

- **Sensor selection** – to select a wireless EU-C-8zr sensor that requires registration.
- **Calibration** - The calibration is performed at installation or after prolonged use of the sensor if the temperature measured by the sensor deviates from the actual temperature. Adjustment range is from -10°C to +10°C with a step of 0.1°C.

In the case of a registered wireless sensor, the subsequent parameters relate to the range and level of the battery.

4.7. HEATING STOPPING

Function to prevent actuators from turning on at specified time intervals.

- **Date settings**
 - **Heating deactivation** – To set the date from which the heating will be switched off
 - **Heating activation** – To set the date from which the heating will be switched on
- **Weather control** - When the external sensor is connected, the main screen will display the external temperature, while the controller menu will display the mean external temperature.

The function based on the outside temperature allows a determination of the mean temperature, which will then work on the basis of the temperature threshold. If the mean temperature exceeds the specified temperature threshold, the controller will switch off the heating of the zone in which the weather control function is active.

- **ON** – to use the weather control, the selected sensor must be enabled
- **Averaging time** – users set the time on the basis of which the mean outside temperature will be calculated. Setting range is from 6 to 24 hours.
- **Temperature threshold** – this is a function protecting against excessive heating of the given zone. The zone in which the weather control is switched on will be blocked from overheating if the mean daily outdoor temperature exceeds the set threshold temperature. For example, when temperatures rise in Spring time, the controller will block unnecessary room heating.
- **Average external temperature** – temperature value calculated on the basis of the **Averaging time**

4.8. POTENTIAL-FREE CONTACT

The EU-L-4X WiFi controller will activate the potential-free contact (after counting down the delay time) when any of the zones have not reached the set temperature (heating – when the zone is underheated, cooling – when the temperature in the zone is too high). The controller deactivates the contact once the set temperature has been reached.

- **Operation delay** - the function allows users to set the delay time of switching on the potential-free contact after the temperature drops below the set temperature in any of the zones.

4.9. PUMP

The EU-L-4X WiFi controller controls the operation of the pump – it switches on the pump (after counting down the delay time) when any of the zones is underheated and when the floor pump option is enabled in the respective zone. When all zones are heated (the set temperature is reached), the controller switches off the pump.

- **Operation delay** - the function allows users to set the delay time of switching on the pump after the temperature drops below the set temperature in any of the zones. This switching on delay is applied to allow the valve actuator to open.

4.10. HEATING - COOLING

The function allows users to select the operation mode:

- **Heating** – all zones are heated
- **Cooling** – all zones are cooled
- **Automatic** – the controller switches the mode between heating and cooling based on the two-state input

4.11. ANTI-STOP SETTINGS

This function forces the operation of pumps and valves (check the option first), which prevents scale deposition during the period of prolonged inactivity of pumps and valves, e.g. outside the heating season. If this function is enabled, the pump and valves will switch on for the set time and with a specified interval (e.g. every 10 days for 5 min.)

4.12. MAXIMUM HUMIDITY

If the current humidity level is higher than the set maximum humidity, the cooling of the zone will be disconnected.

CAUTION



The function is only active in **Cooling** mode, provided that a sensor with humidity measurement is registered in the zone.

4.13. LANGUAGE

The function allows users to change the controller language version.

4.14. HEAT PUMP

This is a mode dedicated for an installation operating with a heat pump and enables optimal use of its capabilities.

- **Energy saving mode** – selecting this option will start the mode and more options will appear
- **Minimum pause time** – a parameter limiting the number of compressor switches, which allows extending the life of the compressor.
Regardless of the need to reheat a given zone, the compressor will start only after the time counted from the end of the previous work cycle has elapsed.
- **Bypass** – an option needed in the absence of a buffer and a heat pump with an appropriate heat capacity.
It relies on sequential opening of subsequent zones every specified time.
 - **Floor pump** – activate/deactivate floor pump
 - **Cycle time** – the time for which the selected zone will be opened

4.15. FACTORY SETTINGS

The function allows users to return to the fitter's menu settings saved by the manufacturer.

5. SERVICE MENU

The controller service menu is only available to authorized persons and is protected by a proprietary code held by Tech Sterowniki.

6. FACTORY SETTINGS

The function allows users to return to the default settings of the controller as defined by the manufacturer.

7. SOFTWARE VERSION

When this option is activated, the manufacturer's logo will appear on the display, along with the controller software version number. The software revision is required when contacting the Tech Sterowniki service.

5. ALARMS LIST

Alarm	Possible cause	How to fix it
Sensor damaged (room sensor, floor sensor)	Sensor shorted or damaged	- Check the connection with the sensor - Replace the sensor with a new one or contact the service staff if necessary.
No communication with sensor / wireless regulator	- No range - No battery - Flat battery	- Put the sensor/regulator in a different place - Insert batteries in the sensor/regulator The alarm deactivates automatically when communication is established.
No communication with module / control panel / wireless contact	No range	- Put the device in a different place or use a repeater to extend the range. The alarm deactivates automatically when communication is established.
Software update	System communication versions in the two devices are not compatible	Update the software to the latest version.

STT-868 actuator alarms		
ERROR #0	Flat battery in the actuator	Replace the batteries
ERROR #1	Some mechanical or electronic parts have been damaged	Contact the service staff
ERROR #2	<ul style="list-style-type: none"> - No piston controlling the valve - Too big stroke (movement) of the valve - The actuator has been incorrectly mounted on the radiator - Inappropriate valve on the radiator 	<ul style="list-style-type: none"> - Install a piston controlling the actuator - Check the valve stroke - Install the actuator correctly - Replace the valve on the radiator
ERROR #3	<ul style="list-style-type: none"> - The valve got stuck - Inappropriate valve on the radiator - Too little stroke (movement) of the valve 	<ul style="list-style-type: none"> - Inspect the valve operation - Replace the valve on the radiator - Check the valve stroke
ERROR #4	<ul style="list-style-type: none"> - No range - No batteries 	<ul style="list-style-type: none"> - Check the distance between the actuator and the controller - Insert batteries into the actuator <p>After the communication is re-established, the alarm is deactivated automatically.</p>
STT-869 actuator alarms		
ERROR #1 - Calibration error 1 – Moving the screw to the mounting position	<ul style="list-style-type: none"> - The limit switch sensor is damaged 	<ul style="list-style-type: none"> - Calibrate actuator again by holding the communication button until the third flash of green light - Call the service staff
ERROR #2 - Calibration error 2 – The screw is maximally pulled out. No resistance while pulling out	<ul style="list-style-type: none"> - The actuator has not been screwed to the valve or has not been screwed completely - The valve stroke is too big or the valve dimensions are not typical - Actuator current sensor is damaged 	<ul style="list-style-type: none"> - Check if the controller has been installed properly - Replace the batteries - Calibrate actuator again by holding the communication button until the third flash of green light - Call the service staff
ERROR #3 - Calibration error 3 - The screw has not been pulled out enough - the screw meets resistance too early	<ul style="list-style-type: none"> - The valve stroke is too small or the valve dimensions are not typical - Actuator current sensor is damaged - Low battery level 	<ul style="list-style-type: none"> - Replace the batteries - Call the service staff
ERROR #4 - No feedback	<ul style="list-style-type: none"> - The master controller is switched off - Poor range or no range to connect with the master controller - Radio module in the actuator is damaged 	<ul style="list-style-type: none"> - Check if the master controller is on - Reduce the distance from the master controller - Call the service staff
ERROR #5 - Low battery level	The battery is flat	- Replace the batteries
ERROR #6 - Encoder is locked	The encoder is damaged	
ERROR #7 - To high voltage	<ul style="list-style-type: none"> - Unevenness of the screw, the thread etc. may cause excessive resistance - Too high resistance of gear or motor 	<ul style="list-style-type: none"> - Calibrate actuator again by holding the communication button until the third flash of green light - Call the service staff

	- Current sensor is damaged	
ERROR #8 - Limit switch sensor error	Limit switch sensor damaged	
EU-G-X actuator alarms		
ERROR #1 - Calibration error 1	Bolt retraction to mounting position took too long.	Locked/damaged actuator piston. Check the assembly and recalibrate the actuator.
ERROR #2 - Calibration error 2	Bolt maximally extended as it did not meet any resistance during extension.	- actuator was not screwed properly onto the valve - the actuator was not fully tightened onto the valve - actuator movement was excessive, or non-standard valve encountered - motor load measurement failure occurred Check the assembly and recalibrate the actuator.
ERROR #3 - Calibration error 3	Bolt extension too short. The bolt met resistance too early during the calibration process.	- valve movement was too small, or a non-standard valve encountered - motor load measurement failure - motor load measurement inaccurate due to low battery charge Check the assembly and recalibrate the actuator.
ERROR #4 - Actuator feedback communication error.	For the last x minutes, the actuator did not receive a data package via wireless communication. After this error is triggered, the actuator will set itself to 50% opening. The error will reset after a data package is received.	- master controller disabled - poor signal or no signal originating from the master controller - defective RC module in the actuator
ERROR #5 - Battery low	The actuator will detect battery replacement after voltage rises and launch calibration	- battery depleted
ERROR #6	-	-
ERROR #7 - Actuator blocked		- while changing the opening of the valve, excessive load was encountered Recalibrate the actuator.

VII.SOFTWARE UPGRADE

To upload new software, disconnect the controller from the network, insert the USB flash drive containing the new software into the USB port, then connect the controller to the network - while holding down the EXIT button. Hold down the EXIT button until a single beep is heard marking the start of uploading new software. Once the task is completed, the controller will restart.



CAUTION

- The process of uploading new software to the controller may only be carried out by a qualified installer. After changing the software, it is not possible to restore the previous settings.
- Do not turn off the controller while updating the software.

VIII. TECHNICAL DATA

Power supply	230V ± 10% / 50 Hz
Max. power consumption EU-L-4X WiFi	4W
Max. power consumption EU-L-4X WiFi + EU-ML-4X WiFi	5W
Operation temperature	5 ÷ 50°C
Maximum load of potential outputs 1-4	0.3A
Maximum load of pump	0.5A
Potential-free cont. nom. out. load	230V AC / 0.5A (AC1) * 24V DC / 0.5A (DC1) **
Thermal resistance of NTC sensor	-30 ÷ 50°C
Operation frequency	868MHz
Fuse	6.3A
Transmission IEEE 802.11 b/g/n	

* AC1 load category: single-phase, resistive or slightly inductive AC load.

** DC1 load category: direct current, resistive or slightly inductive load.

TECH TECH CONTROLLERS

EU DECLARATION OF CONFORMITY

Hereby, we declare under our sole responsibility that **EU-L-4X WiFi** manufactured by TECH STEROWNIKI II Sp. z o.o., headquartered in Wieprz Biała Droga 31, 34-122 Wieprz, is compliant with Directive **2014/53/EU** of the European parliament and of the Council of 16 April 2014 on the harmonisation of the laws of the Member States relating to the making available on the market of radio equipment, Directive **2009/125/EC** establishing a framework for the setting of ecodesign requirements for energy-related products as well as the regulation by the MINISTRY OF ENTREPRENEURSHIP AND TECHNOLOGY of 24 June 2019 amending the regulation concerning the essential requirements as regards the restriction of the use of certain hazardous substances in electrical and electronic equipment, implementing provisions of Directive (EU) 2017/2102 of the European Parliament and of the Council of 15 November 2017 amending Directive 2011/65/EU on the restriction of the use of certain hazardous substances in electrical and electronic equipment (OJ L 305, 21.11.2017, p. 8).

For compliance assessment, harmonized standards were used:

PN-EN IEC 60730-2-9 :2019-06 art. 3.1a Safety of use

PN-EN IEC 62368-1:2020-11 art. 3.1 a Safety of use

PN-EN 62479:2011 art. 3.1 a Safety of use

ETSI EN 301 489-1 V2.2.3 (2019-11) art.3.1b Electromagnetic compatibility

ETSI EN 301 489-3 V2.1.1 (2019-03) art.3.1 b Electromagnetic compatibility

ETSI EN 301 489-17 V3.2.4 (2020-09) art.3.1b Electromagnetic compatibility

ETSI EN 300 328 V2.2.2 (2019-07) art.3.2 Effective and coherent use of radio spectrum

ETSI EN 300 220-2 V3.2.1 (2018-06) art.3.2 Effective and coherent use of radio spectrum

ETSI EN 300 220-1 V3.1.1 (2017-02) art.3.2 Effective and coherent use of radio spectrum

PN EN IEC 63000:2019-01 RoHS.

Wieprz, 02.02.2024

Paweł Jura

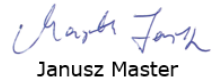
Janusz Master

Prezesa firmy

**TECH
TECH
CONTROLLERS**

Central headquarters:

ul. Biała Droga 31, 34-122 Wieprz

Service:

ul. Skotnica 120, 32-652 Bulowice

phone: **+48 33 875 93 80**

e-mail: **serwis@techsterowniki.pl**

www.tech-controllers.com