

# TECH TECH CONTROLLERS

USER MANUAL  
EU-292 v2, v3

EN

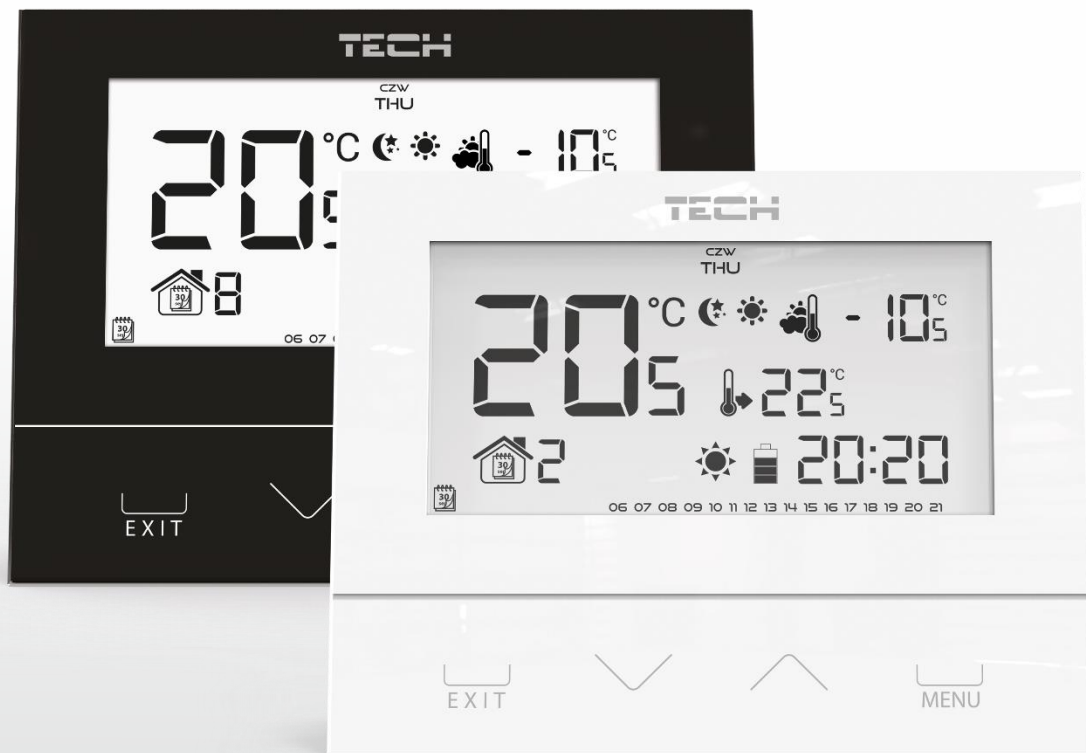

[www.tech-controllers.com](http://www.tech-controllers.com)



# EU-292 User's manual

---

## Table of contents

I.	Safety.....	4
II.	Description of the device .....	5
III.	Installation .....	6
III.a)	Connection diagrams (3 versions) .....	7
IV.	Receiver for wireless controller .....	9
V.	External temperature sensor.....	10
VI.	First start-up .....	11
VII.	How to use the controller .....	11
VII.a)	Principle of operation .....	11
VII.b)	Operation modes.....	11
VII.b)	Main screen view and description .....	14
VII.c)	Controller functions .....	16
VII.c.1)	Block diagram – main menu .....	16
VII.c.2)	Day of the week .....	17
VII.c.3)	Time settings .....	17
VII.c.4)	Day from.....	17
VII.c.5)	Night from.....	17
VII.c.6)	Optimum start.....	18
VII.c.7)	Service menu .....	18
VII.c.8)	Weekly control .....	19
VII.c.9)	Floor sensor .....	21
VII.c.10)	Maximum floor temperature .....	22
VII.c.11)	Floor temperature hysteresis .....	22
VII.c.12)	Minimum floor temperature.....	23
VII.c.13)	Pre-set comfort temperature .....	23
VII.c.14)	Pre-set economical temperature .....	23
VII.c.15)	Pre-set temperature hysteresis.....	24
VII.c.16)	Temperature sensor calibration .....	24
VIII.	Technical data .....	24

## I. Safety

Before using the device for the first time the user should read the following regulations carefully. Not obeying the rules included in this manual may lead to personal injuries or controller damage. The user's manual should be stored in a safe place for further reference. In order to avoid accidents and errors it should be ensured that every person using the device has familiarized themselves with the principle of operation as well as security functions of the controller. If the device is to be sold or put in a different place, make sure that the user's manual is there with the device so that any potential user has access to essential information about the device.

The manufacturer does not accept responsibility for any injuries or damage resulting from negligence; therefore, users are obliged to take the necessary safety measures listed in this manual to protect their lives and property.



### **WARNING**

- The device should be installed by a qualified electrician.
- The regulator should not be operated by children.



### **WARNING**

- Any use other than specified by the manufacturer is forbidden.
- Before and during the heating season, the controller should be checked for condition of its cables. The user should also check if the controller is properly mounted and clean it if dusty or dirty.



Care for the natural environment is our priority. Being aware of the fact that we manufacture electronic devices obligates us to dispose of used elements and electronic equipment in a manner which is safe for nature. As a result, the company has received a registry number assigned by the Main Inspector of Environmental Protection. The symbol of a crossed out rubbish bin on a product means that the product must not be thrown out to ordinary waste bins. By segregating waste intended for recycling, we help protect the natural environment. It is the user's responsibility to transfer waste electrical and electronic equipment to the selected collection point for recycling of waste generated from electronic and electrical equipment.

### **II. Description of the device**

EU-292 room regulator is intended for controlling the heating or cooling device (e.g. gas, oil or electric furnace or the CH boiler controller). Its main task is to maintain the pre-set temperature in the flat by sending a signal to the heating/cooling device (contact opening) when the desired temperature is reached.

Advanced software enables the regulator to fulfil a wide range of functions:

- maintaining the pre-set room temperature
- manual mode
- day/night program
- weekly control
- control of the underfloor heating system (optional; an additional temperature sensor is necessary)

Controller equipment:

- touch buttons
- front panel made of 3mm glass
- built-in temperature sensor
- batteries

Controller versions:

- v2 – wireless, with temporary backlight. It may be optionally equipped with a wireless external sensor. This controller version cooperates with an additional signal receiver, installed near the heating device.
- v3 – wired, with temporary backlight.

### III. Installation

The controller should be installed by a qualified person. The diagrams below show an example of connecting the regulator to the controller and heating device.

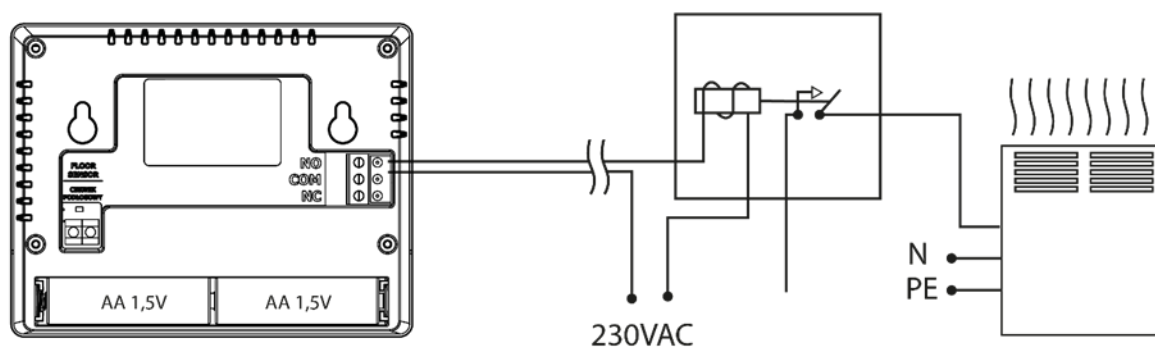
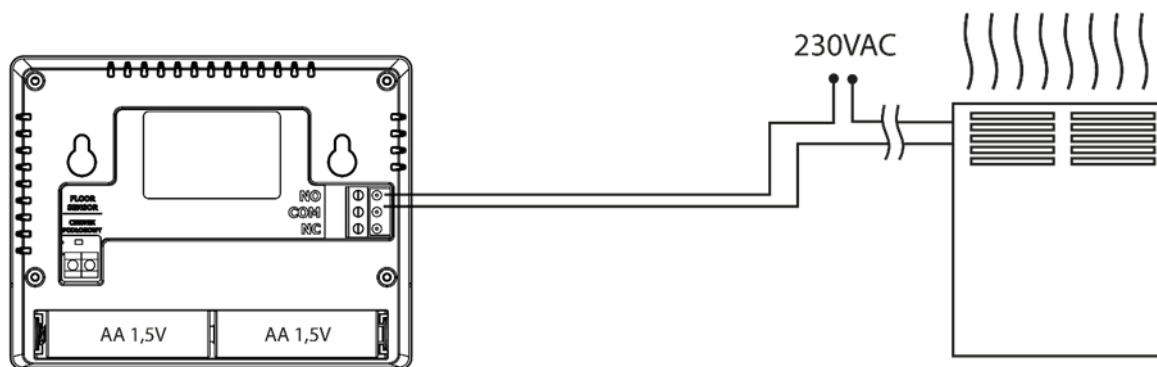
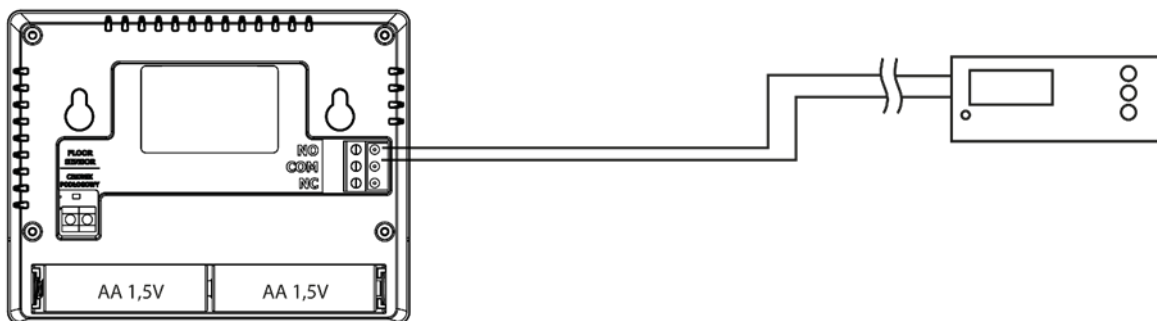
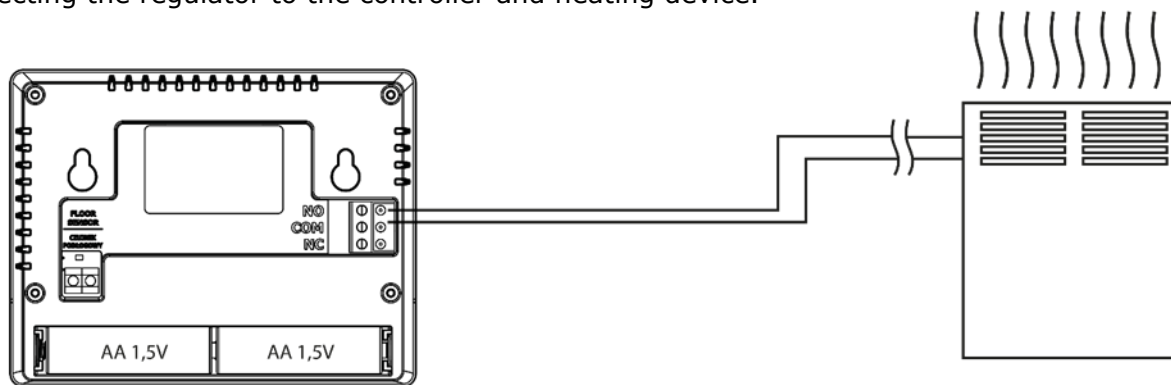

# EU-292 User's manual

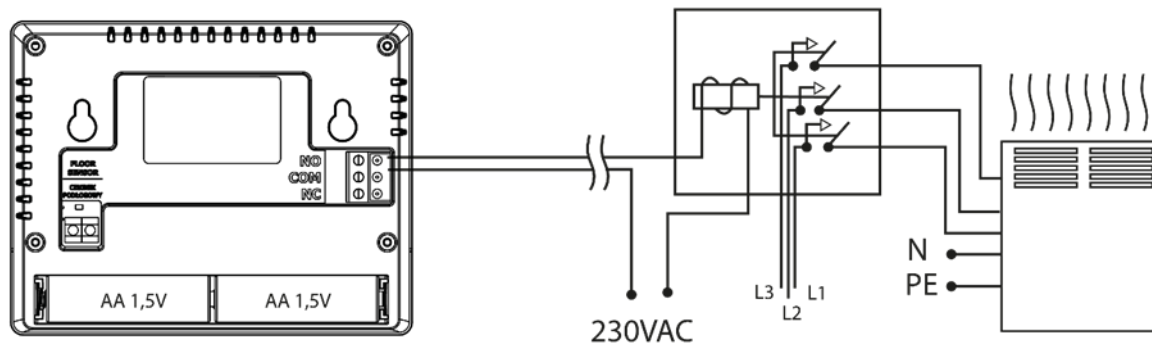

EU-292 controller may be installed as a panel mountable on the wall. You can use the stand and place the regulator anywhere.

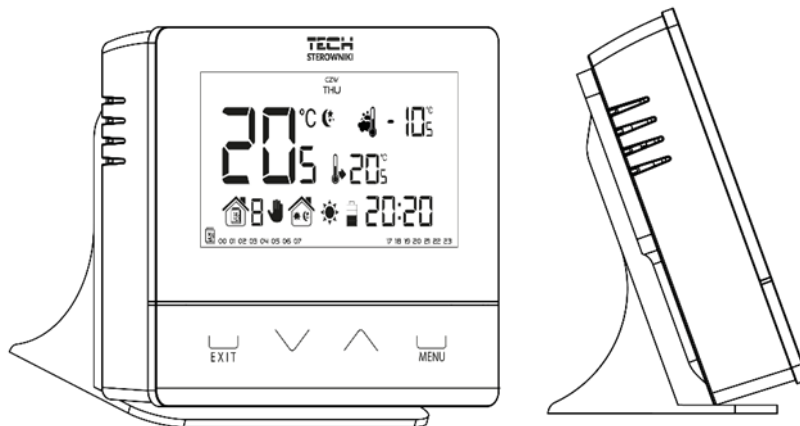
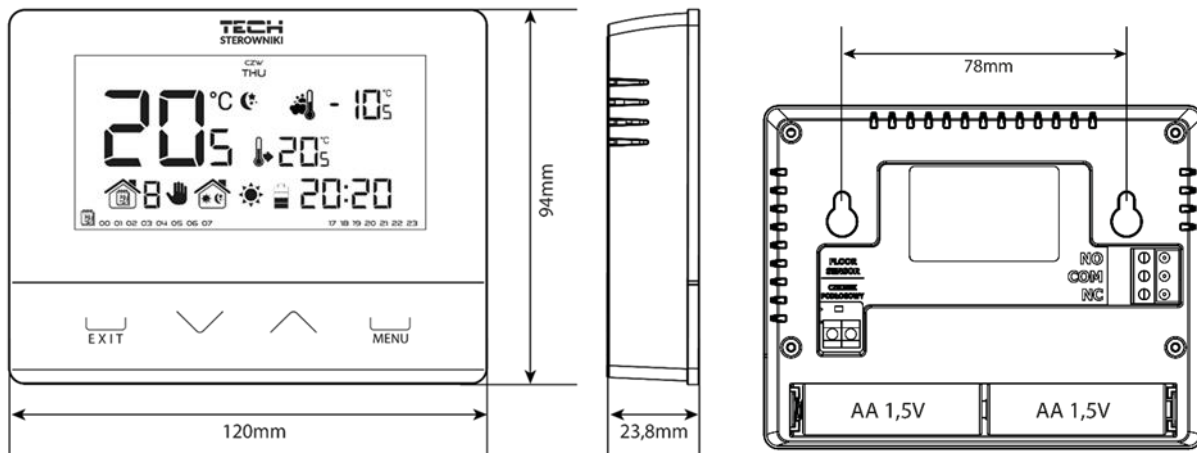

## III.a) Connection diagrams (3 versions)

The room regulator should be connected to the heating device via a two-core cable. When connecting devices with over 1A load, it is necessary to use a contactor. Optionally, it is possible to connect an additional sensor to the floor sensor contact – additional functions will appear in the controller menu.

In the case of wireless connection, use the diagram below – the two-core communication cable must be connected to appropriate sockets in the receiver.

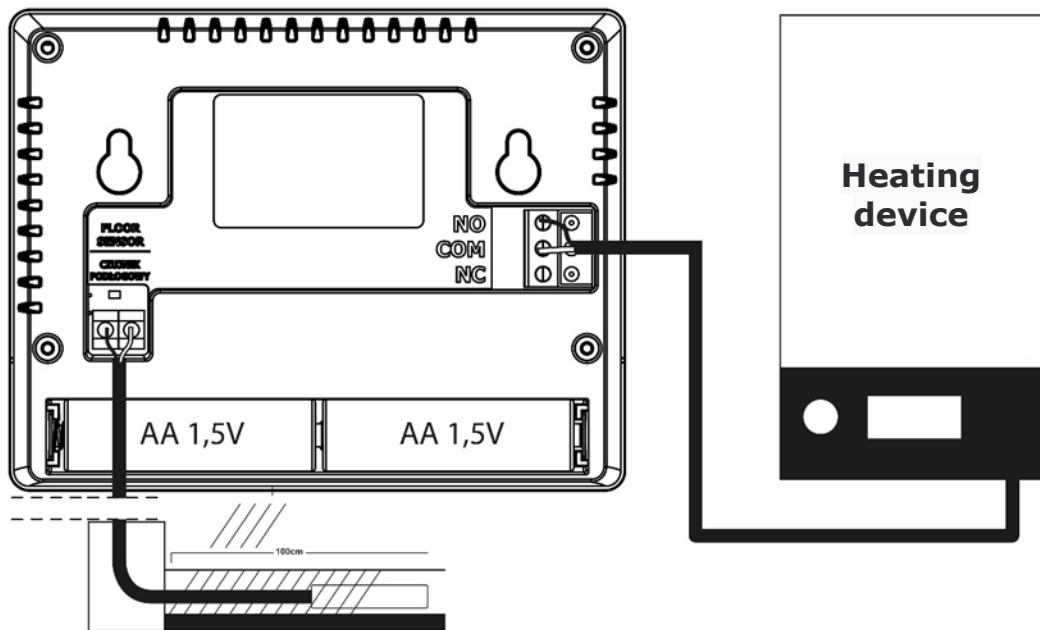

**Connection diagrams EU-292v2**

In the case of wireless connection, use the diagram below – the two-core communication cable must be connected to appropriate sockets in the receiver

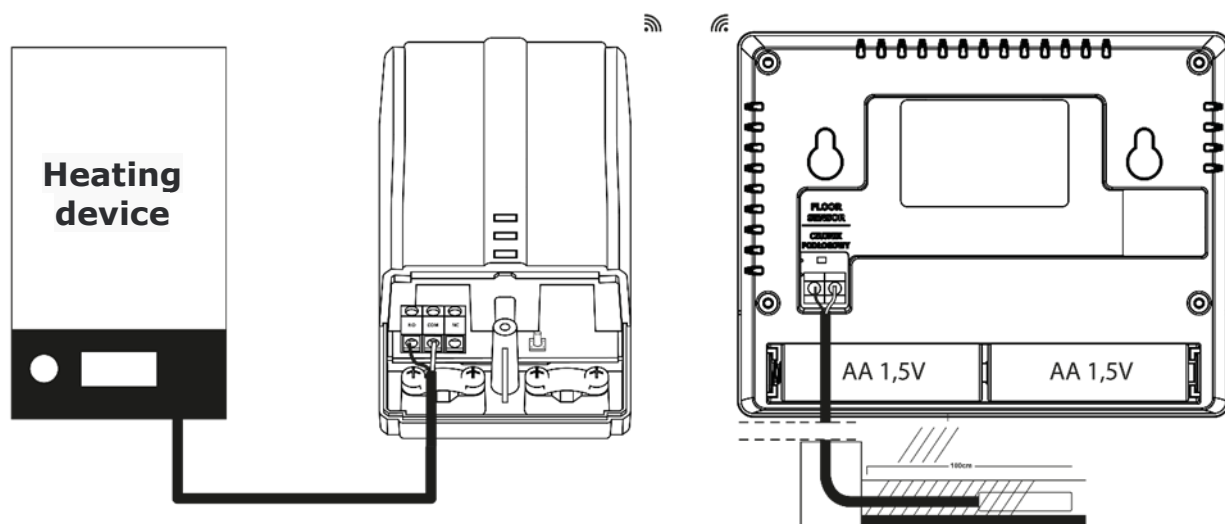

**WARNING**

If pump manufacturer requires an external main switch, power supply fuse or additional residual current device selective for distorted currents it is recommended not to connect pumps directly to pump control outputs.

To avoid damaging to the device, an additional safety circuit must be used between the regulator and the pump. The manufacturer recommends the ZP-01 pump adapter, which must be purchased separately.



## IV. Receiver for wireless controller

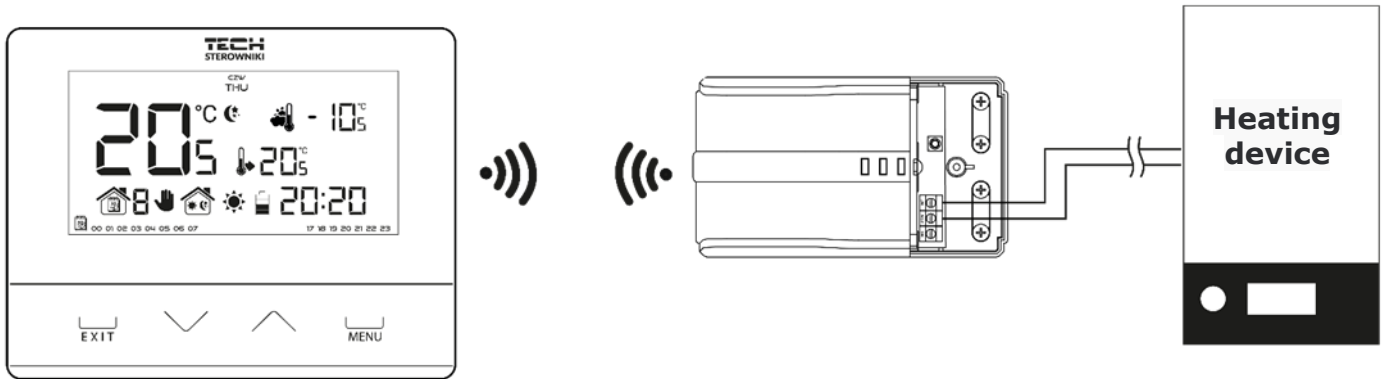

EU-292v2 regulator communicates with the heating device (or the CH boiler controller) via radio signal sent to the receiver. The receiver is connected to the heating device (or CH boiler controller) via a two-core cable whereas the communication with the room regulator is performed wirelessly via radio signal.

The receiver has the following control lights:

- green 1 (1)– indicates data reception, goes on during channel change;
- red (2)– indicates receiver operation;
- green 2 (3) – goes on when the room temperature fails to reach the pre-set value – the heating device is switched on.



### NOTE

In case of communication failure (e.g. when the battery is flat), the receiver automatically disconnects the heating device after 15 minutes.

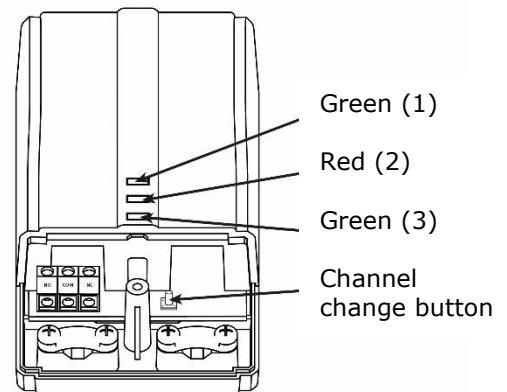

### How to change the communication channel

Channel "35" is the default communication channel in the room regulator. The channel may be easily changed (if the current channel is used by other devices). To change the channel, press and hold the channel change button (4) for about 10 seconds until the green control light (1) goes on. Next, change the communication channel in the room regulator following the procedure described in part VII.c.7. Confirm with the channel change button. The green light on the receiver should go off.

## V. External temperature sensor

EU-292v2 room regulator may optionally be equipped with an external temperature sensor. The sensor should be mounted in a shaded place so that it is not affected by the weather conditions. The current temperature value will be sent to the room regulator every few minutes and it will be displayed on the main screen.

The external sensor communicates with the room regulator via radio signal. Both the room regulator and the external sensor are pre-configured to operate on channel "35", but the user may easily change the channel (if the current channel is used by other devices).

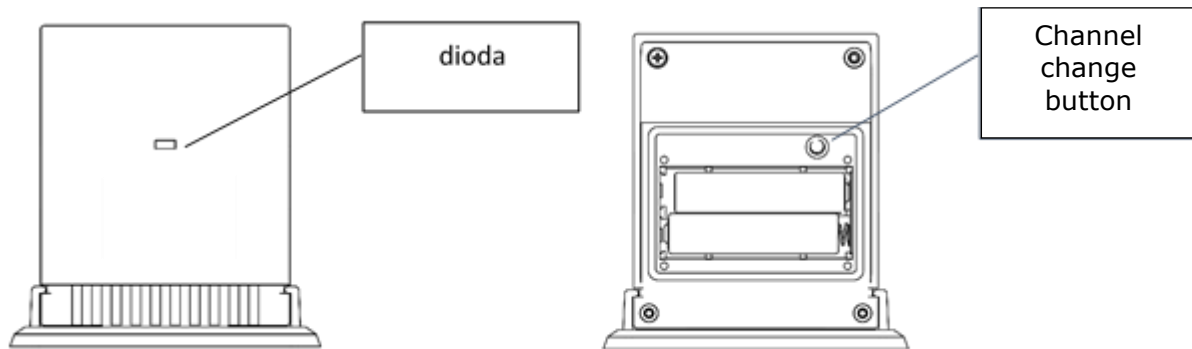

### How to change communication channel:

In order to change the channel, press and hold the channel change button. After the control light on the sensor flashes, the process of channel change has been initiated. Hold the button and wait until the light starts flashing again. The number of flashes corresponds to the first digit of the desired channel number.

Release the button after the desired number of flashes and press it again to set the second digit of the channel number – the control light flashes quickly twice. Hold the button and wait until the light flashes the desired number of times. When the button is released, the control light flashes twice – the new communication channel has been set.

NOTE: In case of a one-digit channel number (channels 0÷9) set 0 as the first digit.

#### Example 1:

28 is the desired communication channel. In order to select this channel, set the first digit - 2, and the second digit - 8.

Press and hold the channel change button - the control light flashes quickly once - the process of channel change has been initiated. Hold the button and wait until the light flashes two more times (the first digit of the channel number - 28).

Release the button and press it again – the control light flashes quickly twice – the process of setting the second digit has been initiated. Hold the button and wait until the light flashes 8 times. When the button is released, the control light flashes quickly twice – the new communication channel has been successfully set.

#### Example 2:

7 is the desired communication channel. In order to select this channel, set the first digit - 0, and the second digit - 7.

Press and hold the channel change button - the control light flashes quickly once - the process of channel change has been initiated. As the first digit is 0, release the button before the control light flashes again. Press the button again – the control light flashes quickly twice – the process of setting the second digit has been initiated. Hold the button and wait until the light flashes 7 times (the second digit of the desired number). When the button is released, the control light flashes quickly twice – the new communication channel has been successfully set.

In case of errors in the channel change process, the control light goes on for ca. 2 seconds. In such a case the channel will not be changed.

### VI. First start-up

#### EU-292 v2:

In order for the controller to operate correctly, the user must follow these steps when starting the device for the first time:

1. Remove the front cover of the controller and insert the batteries.
2. If the room regulator is to control the underfloor heating system, connect the additional sensor to the floor sensor contact.
3. In the case of EU-292v2 connect the two-core cable to appropriate sockets in the receiver.
4. Check if the current communication channel selected in the regulator is the same as in the receiver. "35" is the default communication channel in all devices. If there is a conflict with other devices using radio communication, the user needs to select a different channel.

#### EU-292 v3:

In order for the controller to operate correctly, the user must follow these steps when starting the device for the first time:

1. Remove the front cover of the controller and insert the batteries.
2. If the room regulator is to control the underfloor heating system, connect the additional sensor to the floor sensor contact.
3. Connect the controller to the heating device using a two-core cable.



#### **NOTE**

One zone may only have one room regulator assigned to it. If more room regulators are assigned to one zone, the external controller will not work properly.

### VII. How to use the controller

#### **VII.a) Principle of operation**

The main task of EU-292 room regulator is to maintain the pre-set temperature of the room by sending a signal to the heating/cooling device (contact opening) when the desired temperature is reached. In such a situation, the heating/cooling device is switched off (if the regulator is connected to the CH boiler controller, the CH boiler enters sustain mode).

If the regulator is used in heating mode, it may cooperate with the underfloor heating sensor. In such a case, the contact remains closed when the floor temperature is below the minimum threshold. After the threshold value has been reached, the contact remains closed until the pre-set room temperature is reached. If the floor sensor temperature exceeds the maximum value, the regulator opens the contact regardless of the current room temperature.



#### **NOTE**

In order for the underfloor heating functions to be available in the controller menu, it is necessary to connect an additional sensor to the floor sensor contact.

#### **VII.b) Operation modes**

The user has three operation modes to choose from:

- **Day/night mode**

In this mode the pre-set temperature value depends on the current time of the day. The user may set different temperature values for the daytime and nighttime (comfort temperature and economical temperature) as well as define the exact time of entering day mode and night mode.

In order to activate this mode, press EXIT button until *day/night mode* icon appears on the main screen.

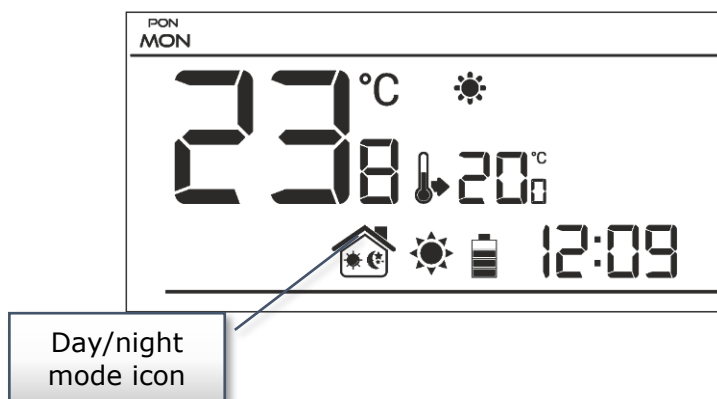

• **Weekly control**

This mode enables the user to define the time when the pre-set comfort temperature and the pre-set economical temperature will apply. The user may set 9 different programs divided into three groups:

- *programs 1÷3* – daily temperature values are set for all days of the week;
- *programs 4÷6* – daily temperature values are set separately for the weekdays (Monday-Friday) and for the weekend (Saturday-Sunday);
- *programs 7÷9* – daily temperature values are set for each day of the week separately.

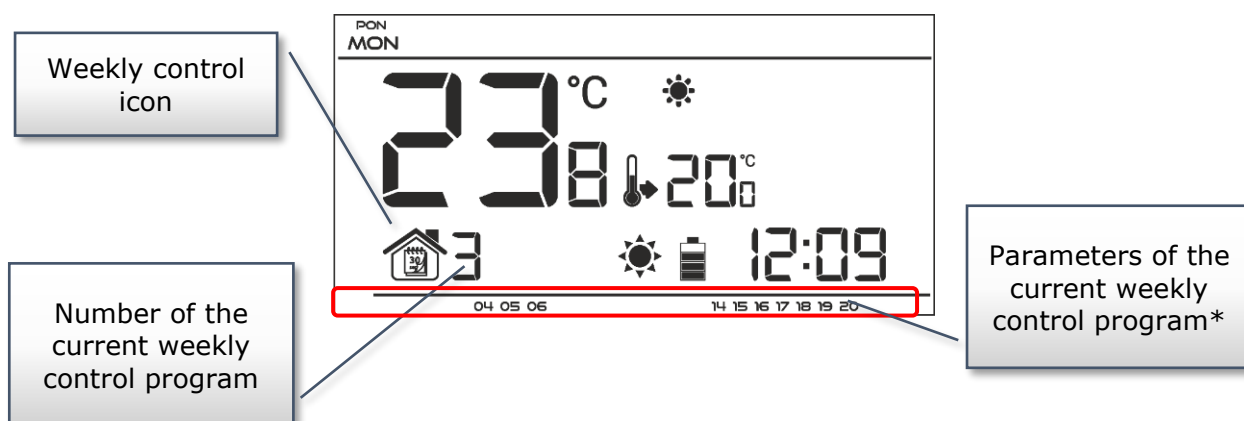

\* The display shows the hours when the comfort temperature applies. In the remaining time period economical temperature applies.

In order to activate this mode, press and hold EXIT button until the weekly control icon appears on the main screen.

• **Manual mode**

In this mode the pre-set temperature is adjusted manually from the main screen view with the use of these buttons: ^ or v . Manual mode is activated when one of these buttons is pressed. When the manual mode is activated, the previous operation mode enters 'sleep mode' until the next pre-programmed temperature change. Manual mode may be deactivated by pressing EXIT button.

# EU-292 User's manual

---

## Example 1 – manual mode activation in Day/night mode

When *Day/night mode* is active, the user changes the pre-set temperature by pressing ^ or v which automatically activates manual mode.

The controller returns to Day/night mode when daytime changes into nighttime (or the other way round) or when the user presses EXIT button.

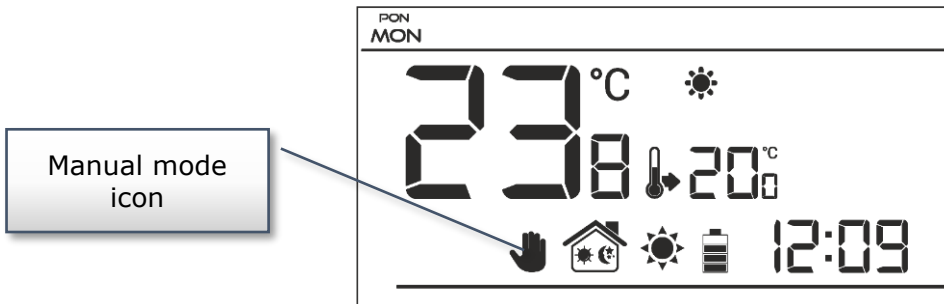

## Example 2 – manual mode activation in weekly control mode

When *weekly control* is active, the user changes the pre-set temperature by pressing ^ or v, which automatically activates manual mode.

The controller returns to weekly control mode when, according to the weekly schedule, economical temperature changes into comfort temperature (or the other way round) or when the user presses EXIT button.

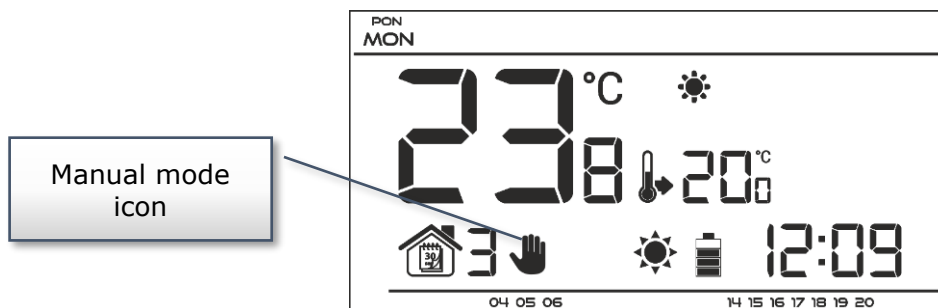

## VII.b) Main screen view and description



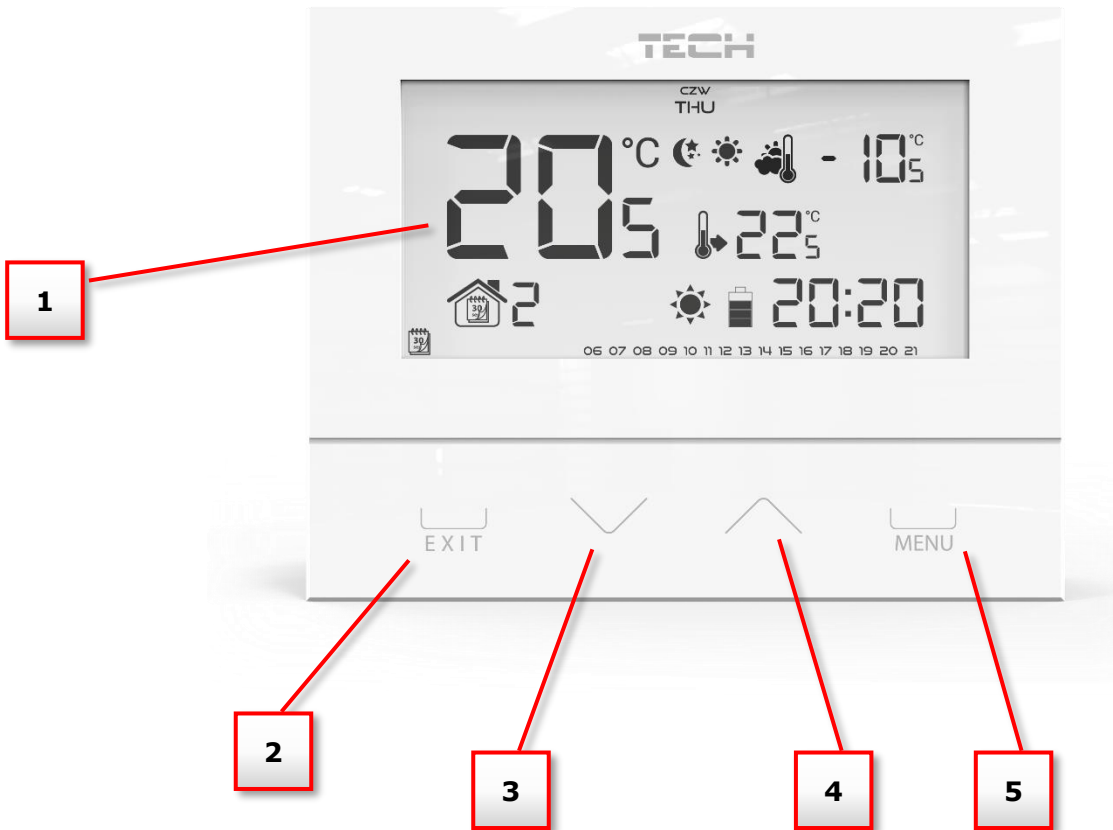



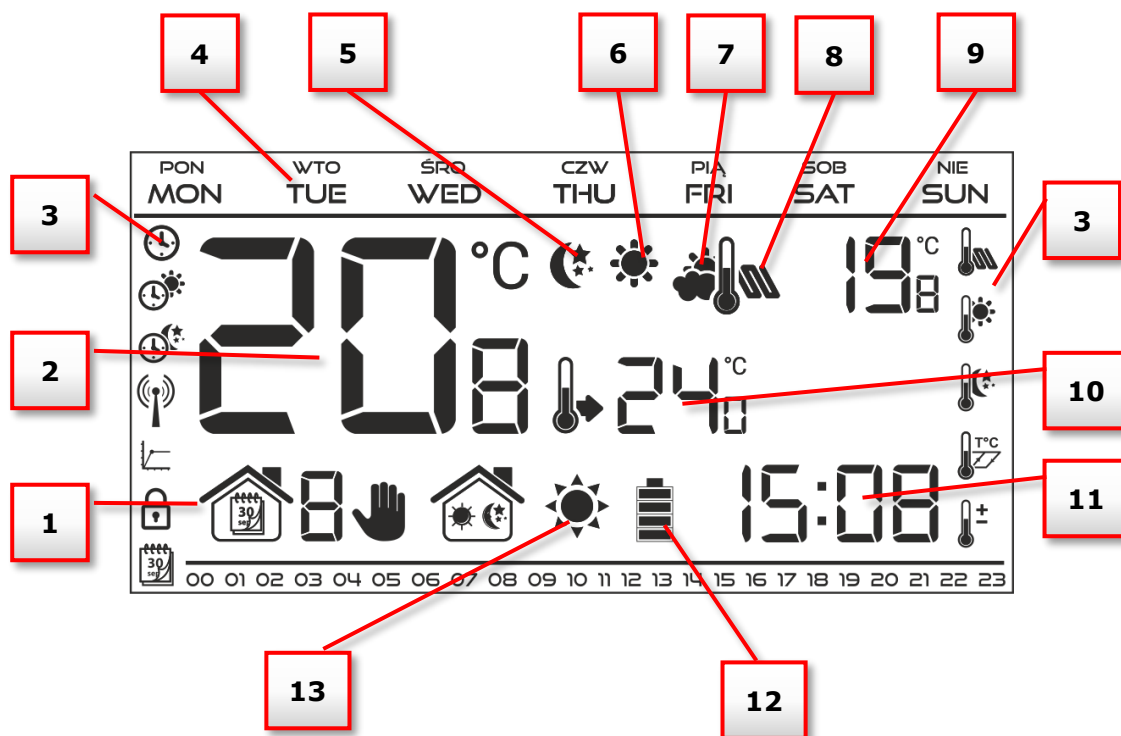



The user operates the device using buttons. While one parameter is being edited, the remaining icons are not displayed.



1. Display
2. **EXIT** - pressing this button in the main screen view activates weekly control mode or day/night mode. After entering the menu, this button is used to confirm the settings and return to the main screen view.
3. Minus button (∇) - pressing this button in the main screen view activates manual mode and decreases the pre-set temperature. After entering the menu, this button is used to adjust parameters, enter the service code etc.
4. Plus button (∧) - pressing this button in the main screen view activates manual mode and increases the pre-set temperature. After entering the menu, this button is used to adjust parameters, enter the service code etc.
5. **MENU** button - hold this button in order to enter the controller menu. While editing parameters press this button to confirm the changes and move on to edit the next parameter.



1. Current operation mode:
  - a. weekly
  - b. manual
  - c. day/night
2. Current temperature of the room
3. Parameters icons (see: table below)
4. Day of the week
5. Icon indicating economical temperature (according to weekly control or day/night settings)
6. Icon indicating comfort temperature (according to weekly control or day/night settings)
7. Icon which indicates displaying current external temperature (no. 9 on the display), active only with wireless controllers (EU-292v2) or with external temperature sensor.
8. Icon which indicates displaying current floor temperature (no. 9 on the display) – it is necessary to connect the floor sensor and activate it in the controller menu.
9. External temperature alternately with floor temperature
10. Pre-set temperature of the room
11. Time
12. Battery level
13. Temperature information (depending on the current operation mode):
  - heating mode - the icon is flashing when the pre-set temperature of the room has not been reached and it is steady when the pre-set temperature has been reached.
  - cooling mode – the icon is moving when the room temperature is above the pre-set value and it is steady when the pre-set temperature has been reached.

Parameters icons:			
	Time settings		Weekly control settings
	Day from...		Floor sensor
	Night from...		Comfort temperature
	Optimum start / heating-cooling mode selection (in service menu)		Economical temperature
	Channel selection		Hysteresis
			Temperature sensor calibration

### VII.c) Controller functions

The user navigates the menu structure using  $\nabla$ ,  $\wedge$ , EXIT and MENU. In order to edit particular parameters, press MENU. Next, press MENU to view the controller functions – the edited parameter is flashing whereas the remaining parameters are not displayed. Use  $\nabla$  or  $\wedge$  to change the parameter settings. Press MENU to confirm the changes and move on to edit the next parameter or press EXIT to confirm the changes and return to the main screen view.

#### V.c.1) Block diagram – main menu

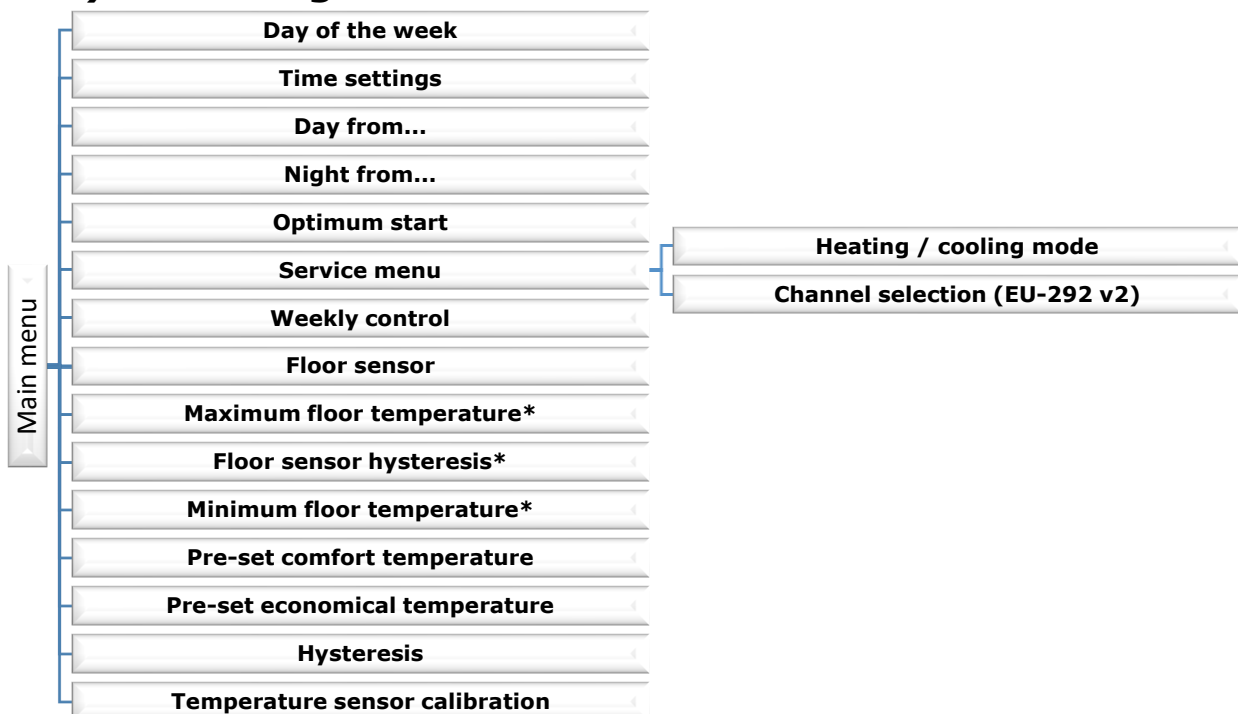



## EU-292 User's manual

\*Functions available in the menu after the floor sensor has been activated by connecting the additional sensor to the floor sensor contact and selecting *ON* in *Floor sensor* submenu.

### VII.c.2) Day of the week

After entering the main menu, all icons which are not connected with the parameter which is being edited are not displayed. The first parameter is day of the week.

Press  $\nabla$  or  $\blacktriangle$  until the current day of the week is displayed. Press MENU to confirm and move on to the next parameter or press EXIT to confirm and return to the main screen view.

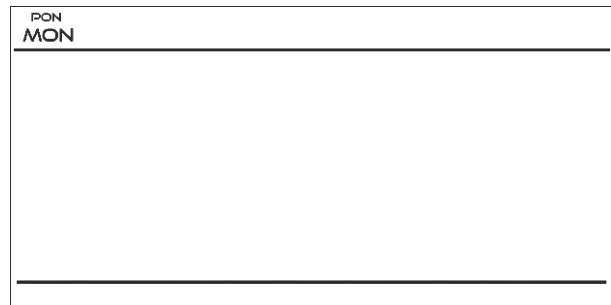

### VII.c.3) Time settings

In order to set current time, press MENU until time setting panel is displayed on the screen.

By pressing  $\nabla$  or  $\blacktriangle$  set the hour and minutes. Press MENU to confirm and move on to the next parameter or press EXIT to confirm and return to the main screen view.

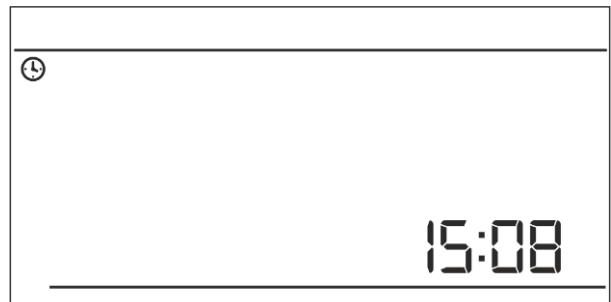

### VII.c.4) Day from...

This function enables the user to define the exact time of entering the day mode. When Day/night mode is active, comfort temperature applies at daytime.

To configure this parameter press MENU until *Day from...* setting appears on the screen.

By pressing  $\nabla$  or  $\blacktriangle$  set the hour and minute of day mode activation.

Press MENU to confirm and move on to the next parameter or EXIT to confirm and return to the main screen view

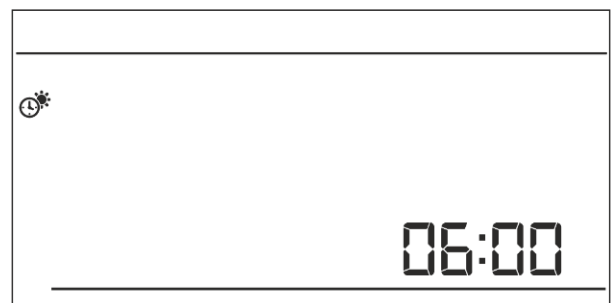

### VII.c.5) Night from...

This function enables the user to define the exact time of entering the night mode. When Day/night mode is active, economical temperature applies at nighttime.

To configure this parameter press MENU until *Night from...* setting appears on the screen.

By pressing  $\nabla$  or  $\blacktriangle$  set the hour and minute of night mode activation.

Press MENU to confirm and move on to the next parameter or press EXIT to confirm and return to the main screen view.

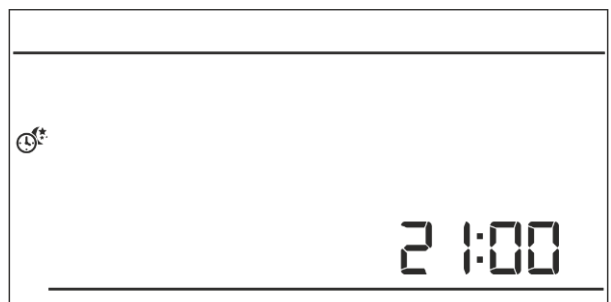

### VII.c.6) Optimum start

Optimum start is an intelligent system controlling the heating/cooling process. It involves constant monitoring of the heating/cooling system efficiency and using the information to activate the heating/cooling process in advance in order to reach the pre-set temperatures.

The system requires no user intervention. It precisely reacts to any changes that affect the efficiency of the heating system. If, for example, some changes have been introduced to the heating system and the house heats up faster than before, the Optimum start system will recognize the changes at the next pre-programmed temperature change (from comfort to economical) and in the next cycle the heating system activation will be adequately delayed, reducing the time needed to reach the desired temperature.

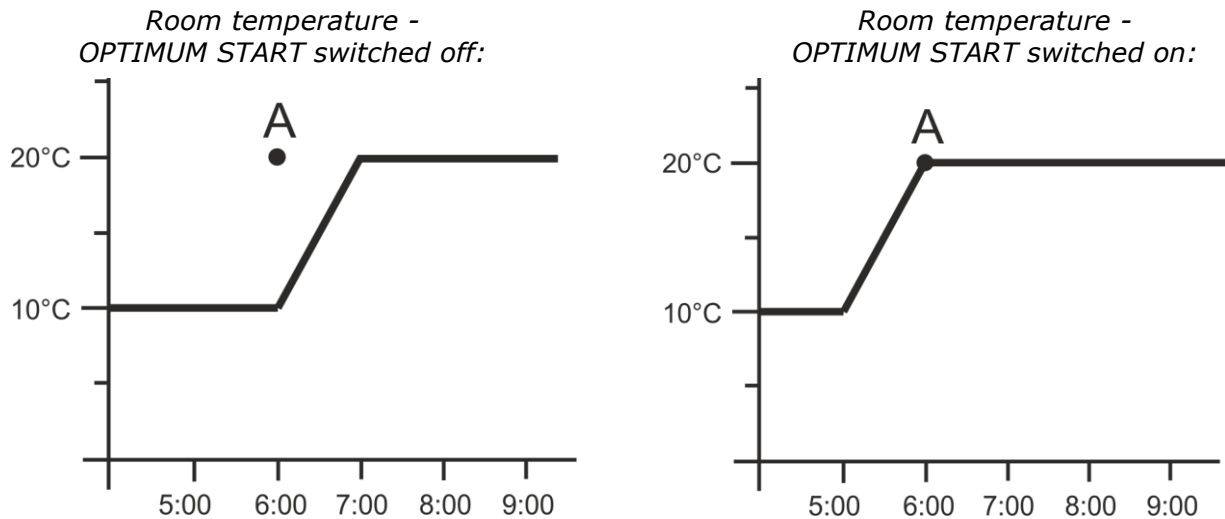

**A** – pre-programmed change from economical temperature to comfort temperature

Activating this function means that at the time of pre-programmed change of the pre-set temperature from comfort to economical or the other way round, the current room temperature is close to the desired value.

In order to configure this parameter, press MENU until *Optimum start* setting panel appears on the screen.

Use  $\nabla$  or  $\blacktriangle$  to activate or deactivate *Optimum start* function. Press MENU to confirm and move on to edit the next parameter or press EXIT to confirm and return to the main screen view.

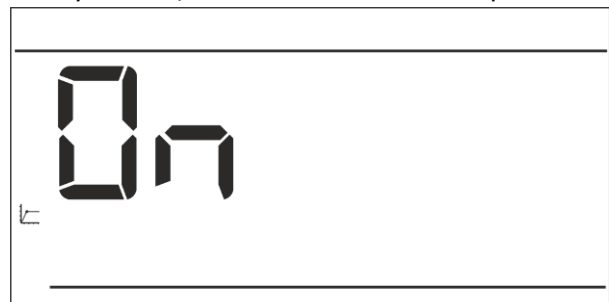

### VII.c.7) Service menu

Certain functions in the controller service menu are secured with a code. In order to adjust their parameters, press MENU until Service menu settings appear on the screen.

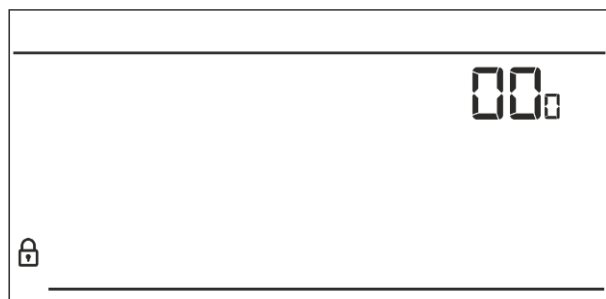

To view the service menu it is necessary to enter the code – 215. Use  $\nabla$  or  $\blacktriangle$  to select the first digit (2) and confirm by pressing and holding MENU until the next digit starts flashing. Follow the same steps selecting the remaining two digits.



# EU-292 User's manual

## Heating/cooling mode

This function enables the user to select the room regulator operation mode:

-  - controlling the cooling system
-  - controlling the heating system

Press  $\nabla$  or  $\blacktriangle$  to select desired type of system. Press MENU to confirm and move on to edit another parameter in the service menu or press EXIT to confirm to return to the main screen view.

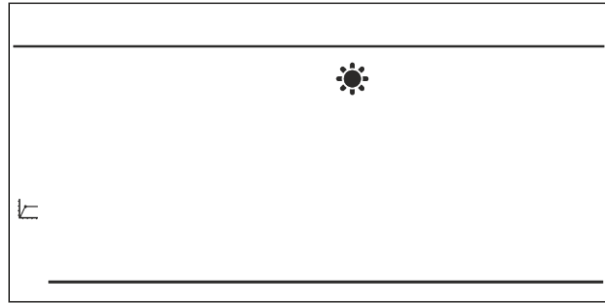

### WARNING

DO NOT select cooling system control if a floor sensor is used as it may damage the underfloor heating system.

## Channel selection (option available only in EU-292v2)

EU-292v2 communicates with the heating device or the CH boiler controller via a receiver using a radio signal. For the communication to take place it is necessary to select the same channel in both the controller and the receiver (and also in the external sensor if it is used). Channel "35" is the default communication channel in all devices. The channel should be changed only if the current channel is used by other devices.

In order to change, go to service menu and press MENU until the channel change panel appears on the screen. Use  $\nabla$  or  $\blacktriangle$  to select the channel. Press MENU to confirm and move on to the next parameter or EXIT to confirm and return to the main screen view.

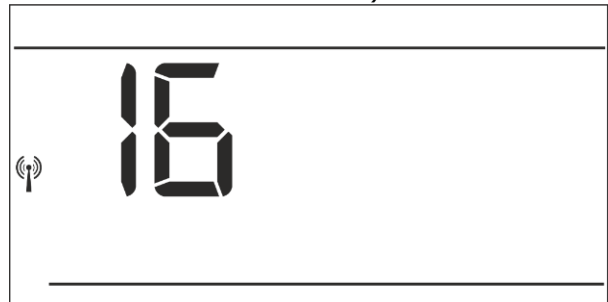

## VII.c.8) Weekly control

This function is used to change the current weekly control program and edit the weekly programs.

### • How to change the current weekly program number

When weekly control is enabled (see: V.b Operation modes) the current program is activated. In order to choose the program number, press MENU until *weekly program* setting appears on the screen.

By pressing and holding MENU button the user opens the program selection panel. Each time the user holds the MENU button, the program number changes. When the desired number appears on the screen, press EXIT - the controller returns to the main screen view and the selected program number is set.

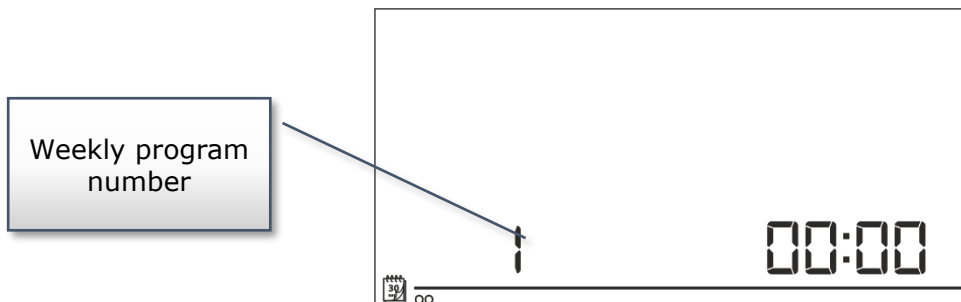

- **How to configure particular weekly programs**

Weekly program allows the user to define the time when comfort temperature and economical temperature will apply. Depending on the program number, the user may set daily temperature values for all days of the week (programs 1÷3), for weekdays and the weekend separately (programs 4÷6) and for each day of the week separately (programs 7÷9).

In order to edit weekly program, press MENU until weekly program setting panel appears on the screen.



STEP 1 – choose the program to be edited:

By pressing and holding MENU button the user opens the program editing panel. Each time the user holds the MENU button, the program number changes. When the desired number appears on the screen, the user may start editing its parameters.

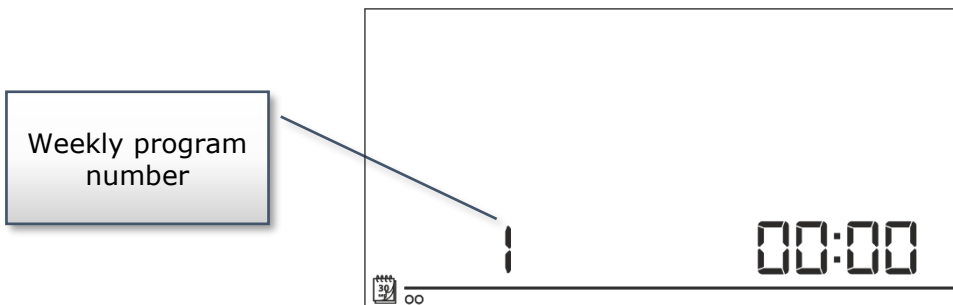

Step 2 – select days of the week

If the user wants to edit programs 1÷3, there is no possibility of selecting particular days of the week as the setting applies to each day.

If the user wants to edit programs 4÷6, it is possible to edit the settings for weekdays and the weekend separately. Press MENU in order to select.

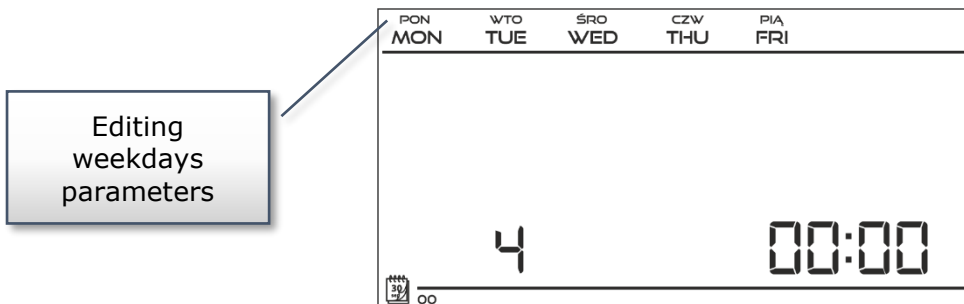

If the user wants to edit programs 7÷9, it is possible to edit the settings for each day separately. Press MENU in order to select a day.

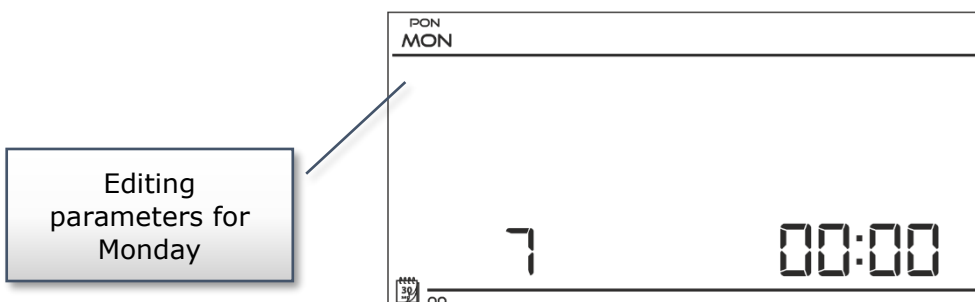

# EU-292 User's manual

## Step 3 – assign comfort temperature or economical temperature to particular hours

An hour which is being edited is displayed on the controller screen. In order to assign comfort temperature, press  $\wedge$ . In order to select economical temperature, press  $\vee$ . The controller automatically moves on to editing the next hour.

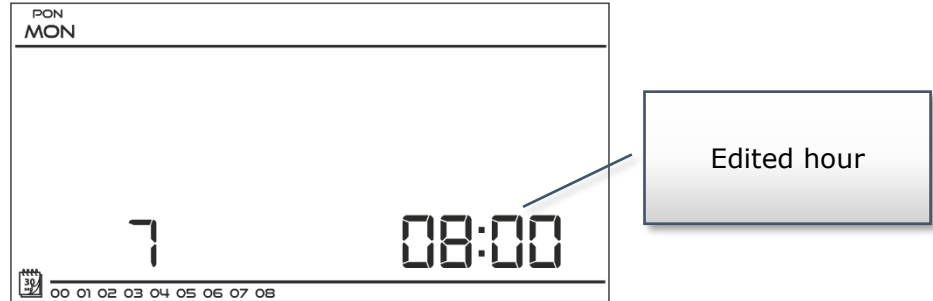

The parameters of the weekly program are displayed at the bottom of the screen: hours to which comfort temperature has been assigned are displayed whereas hours to which economical temperature has been assigned are not displayed.

Example:

The following screenshot presents daily settings of program no. 7 for Monday

24<sup>00</sup>-01<sup>59</sup>- economical temperature

02<sup>00</sup>-06<sup>59</sup>- comfort temperature

07<sup>00</sup>-14<sup>59</sup>- economical temperature

15<sup>00</sup>-21<sup>59</sup>- comfort temperature

22<sup>00</sup>-00<sup>59</sup>- economical temperature

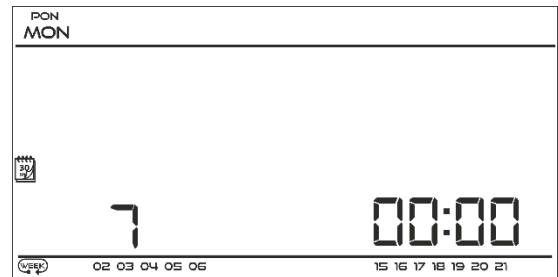

### NOTE



When the user finishes the editing process by pressing EXIT button, the controller returns to the main screen view and this program is selected as the current program.

## VII.c.9) Floor sensor

### NOTE



This parameter is not available in the menu if the additional sensor has not been connected to the floor sensor contact or when the cooling mode is selected.

This function enables the user to activate the floor sensor. When the floor sensor is enabled, the contact status depends also on the floor temperature. The contact remains closed (the device is on) when the floor temperature is lower than the minimum value (regardless of the room temperature). When the minimum temperature of the floor sensor has been exceeded, the contact remains closed until the pre-set room temperature is reached. If the floor sensor temperature exceeds the maximum value, the contact is opened (the device is disabled) regardless of the current room temperature.

Use  $\vee$  or  $\wedge$  to activate/deactivate the floor sensor by selecting *ON* or *OFF*.

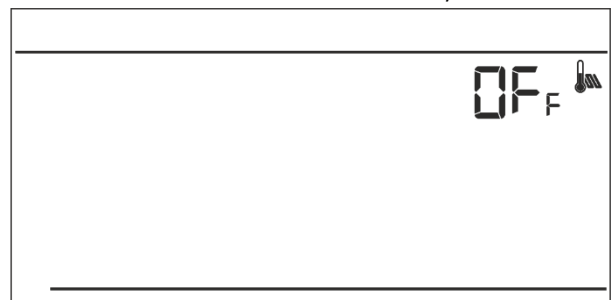

Press MENU to confirm and move on to edit the next parameter or press MENU to confirm and return to the main screen view.



#### NOTE

Selecting *ON* is necessary for the following functions to appear in the menu: maximum floor temperature, floor sensor hysteresis and minimum floor temperature.

### VII.c.10) Maximum floor temperature

It is the floor temperature threshold. When this threshold is exceeded, the contact opens (the device is switched off) regardless of the current room temperature.

Press MENU until the maximum floor temperature panel appears on the screen (it is necessary to activate the floor sensor beforehand by selecting ON) Use  $\nabla$  or  $\blacktriangle$  to select desired temperature value.

Press MENU to confirm and move on to edit the next parameter or press MENU to confirm and return to the main screen view.

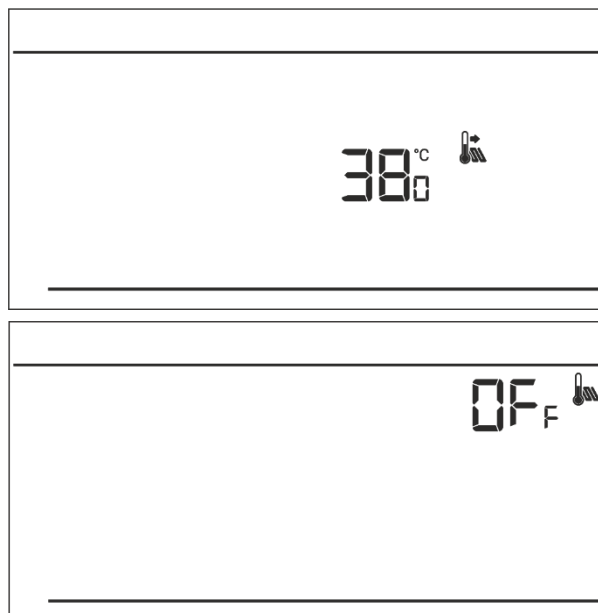

### VII.c.11) Floor temperature hysteresis

Floor temperature hysteresis defines the floor temperature tolerance in order to prevent undesired oscillation in case of small temperature fluctuation within the range of  $0,4 \div 5^\circ\text{C}$ . This parameter concerns both the maximum and the minimum floor temperature.

Example:

Maximum floor temperature =  $45^\circ\text{C}$

Hysteresis =  $2^\circ\text{C}$

Minimum floor temperature =  $30^\circ\text{C}$

The room regulator disables the contact when the temperature of  $45^\circ\text{C}$  on the floor sensor is exceeded. When the temperature starts falling, the contact is activated again at the temperature of  $43^\circ\text{C}$  on the floor sensor (unless the pre-set room temperature has been reached).

With the minimum floor temperature the hysteresis function works the other way round. After the value of  $30^\circ\text{C}$  has been reached on the floor sensor, contact opening/closing depends only on the current room temperature (reaching this value opens the contact). When the floor sensor temperature drops to  $28^\circ\text{C}$  the contact closes regardless of the current room temperature.

## EU-292 User's manual

In order to set the floor temperature hysteresis, press menu until hysteresis panel appears on the screen (floor sensor must be activated beforehand by selecting ON)

Use  $\nabla$  or  $\blacktriangle$  to select desired hysteresis value.

Press MENU to confirm and move on to edit the next parameter or press MENU to confirm and return to the main screen view.

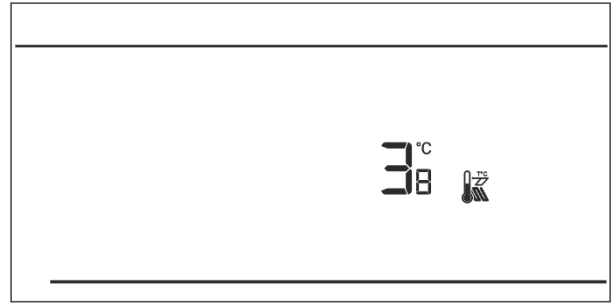

### VII.c.12) Minimum floor temperature

Minimum floor temperature concerns the underfloor heating system operation. After this value has been reached by the floor sensor, contact opening and closing depends only on the current room temperature. Below this value the contact remains closed regardless of other factors.

Press MENU until the minimum floor temperature panel appears on the screen (it is necessary to activate the floor sensor beforehand by selecting ON) Use  $\nabla$  or  $\blacktriangle$  to select desired temperature value.

Press MENU to confirm and move on to edit the next parameter or press MENU to confirm and return to the main screen view.

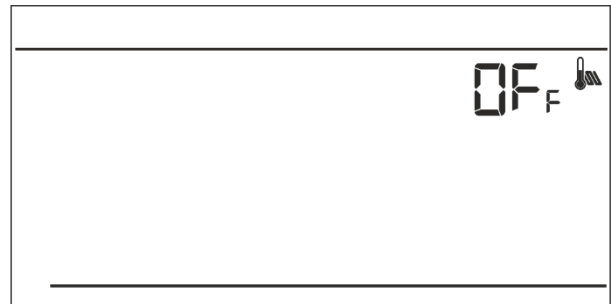
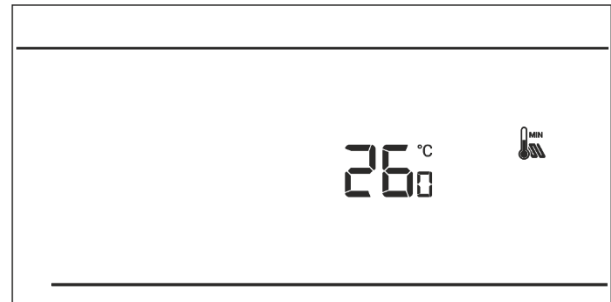

### VII.c.13) Pre-set comfort temperature

Pre-set comfort temperature is used in weekly control mode and day/night mode. Press MENU button until the comfort temperature change panel appears on the screen.

Press  $\nabla$  or  $\blacktriangle$  to set the desired temperature.

Press MENU to confirm and move on to the next parameter or press EXIT to confirm and return to the main screen view.

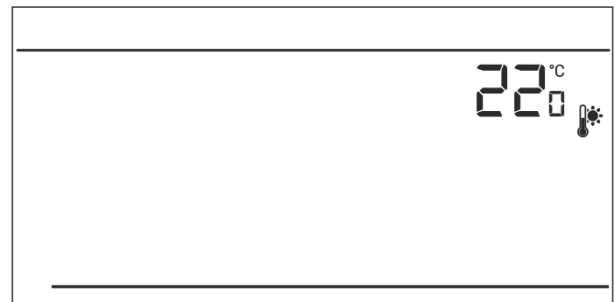

### VII.c.14) Pre-set economical temperature

Pre-set economical temperature is used in weekly control mode and day/night mode. Press MENU button until the economical temperature change panel appears on the screen.

Press  $\nabla$  or  $\blacktriangle$  to set the desired temperature.

Press MENU to confirm and move on to the next parameter or press EXIT to confirm and return to the main screen view.

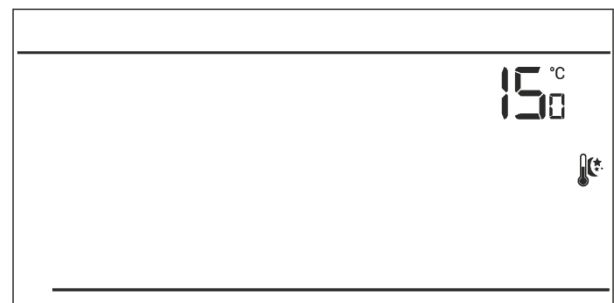

### VII.c.15) Pre-set temperature hysteresis

Room temperature hysteresis defines the pre-set temperature tolerance in order to prevent undesired oscillation in case of small temperature fluctuation (within the range of  $0,2 \div 4^{\circ}\text{C}$ ).

Example:

Pre-set temperature:  $23^{\circ}\text{C}$

Hysteresis:  $1^{\circ}\text{C}$

The room regulator reports that the temperature is too low only when the room temperature drops to  $22^{\circ}\text{C}$ .

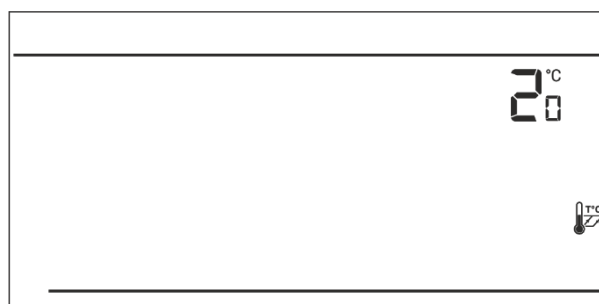

In order to set the hysteresis, press MENU until the hysteresis setting appears on the screen. Use  $\nabla$  or  $\blacktriangle$  to set the desired hysteresis value. Press MENU to confirm and move on to the next parameter or press EXIT to confirm and return to the main screen view.

### VII.c.16) Temperature sensor calibration

It is performed when mounting the regulator or after it has been used for a long time, if the room temperature measured by the internal sensor differs from the actual temperature. Calibration setting range is from  $-10^{\circ}\text{C}$  to  $+10^{\circ}\text{C}$  with the accuracy of  $0,1^{\circ}\text{C}$ .

Press MENU until the sensor calibration panel appears on the screen. Use  $\nabla$  or  $\blacktriangle$  to define correction. Press MENU to confirm and move on to edit the next parameter or press MENU to confirm and return to the main screen view.

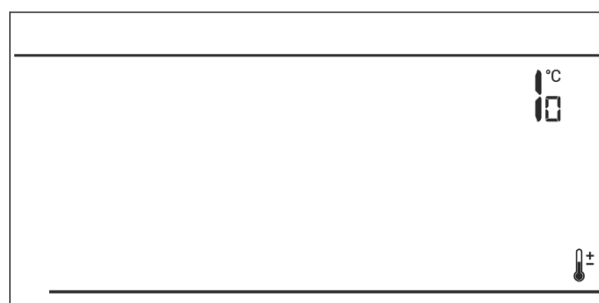

## VIII. Technical data

Range of room temperature settings	$5^{\circ}\text{C} \div 35^{\circ}\text{C}$
Supply voltage	Batteries 2xAA, 1,5V
Potential-free cont. nom. out. Load (EU-292 v3)	230V AC / 0,5A (AC1) * 24V DC / 0,5A (DC1) **
Measurement error	$-/+0,5^{\circ}\text{C}$
Frequency (EU-292 v2)	868MHz

### Room regulator power supply EU-292v2

Supply voltage	230V $\pm$ 10%/50Hz
Ambient temperature	$5^{\circ}\text{C} \div 50^{\circ}\text{C}$
Frequency	868MHz
Potential-free cont. nom. out. Load	230V AC / 0,5A (AC1) * 24V DC / 0,5A (DC1) **

\* AC1 load category: single-phase, resistive or slightly inductive AC load.

\*\* DC1 load category: direct current, resistive or slightly inductive load.





## **EU Declaration of conformity**

Hereby, we declare under our sole responsibility that **EU-292v3** manufactured by TECH STEROWNIKI II Sp. z o.o., head-quartered in Wieprz Biała Droga 31, 34-122 Wieprz, is compliant with Directive **2014/35/EU** of the European Parliament and of the Council of 26 February 2014 on the harmonisation of the laws of Member States relating to **the making available on the market of electrical equipment designed for use within certain voltage limits** (EU OJ L 96, of 29.03.2014, p. 357), Directive **2014/30/EU** of the European Parliament and of the Council of 26 February 2014 on the harmonisation of the laws of Member States relating to **electromagnetic compatibility** (EU OJ L 96 of 29.03.2014, p.79), Directive **2009/125/EC** establishing a framework for the setting of ecodesign requirements for energy-related products as well as the regulation by the MINISTRY OF ENTREPRENEURSHIP AND TECHNOLOGY of 24 June 2019 amending the regulation concerning the essential requirements as regards the restriction of the use of certain hazardous substances in electrical and electronic equipment, implementing provisions of Directive (EU) 2017/2102 of the European Parliament and of the Council of 15 November 2017 amending Directive 2011/65/EU on the restriction of the use of certain hazardous substances in electrical and electronic equipment (OJ L 305, 21.11.2017, p. 8).

For compliance assessment, harmonized standards were used:

**PN-EN IEC 60730-2-9:2019-06, PN-EN 60730-1:2016-10, PN EN IEC 63000:2019-01 RoHS.**

Wieprz, 22.07.2020

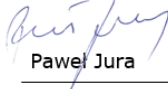
  
Paweł Jura

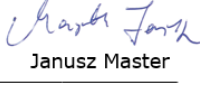
  
Janusz Master

Prezesa firmy

# **TECH TECH CONTROLLERS**

## **EU Declaration of conformity**

Hereby, we declare under our sole responsibility that **EU-292v2** manufactured by TECH STEROWNIKI II Sp. z o.o., head-quartered in Wieprz Biała Droga 31, 34-122 Wieprz, is compliant with Directive **2014/53/EU** of the European parliament and of the Council of 16 April 2014 on the harmonisation of the laws of the Member States relating to the making available on the market of radio equipment, Directive **2009/125/EC** establishing a framework for the setting of ecodesign requirements for energy-related products as well as the regulation by the MINISTRY OF ENTREPRENEURSHIP AND TECHNOLOGY of 24 June 2019 amending the regulation concerning the essential requirements as regards the restriction of the use of certain hazardous substances in electrical and electronic equipment, implementing provisions of Directive (EU) 2017/2102 of the European Parliament and of the Council of 15 November 2017 amending Directive 2011/65/EU on the restriction of the use of certain hazardous substances in electrical and electronic equipment (OJ L 305, 21.11.2017, p. 8).

For compliance assessment, harmonized standards were used:

PN-EN IEC 60730-2-9 :2019-06 art. 3.1a Safety of use

ETSI EN 301 489-1 V2.2.3 (2019-11) art.3.1b Electromagnetic compatibility

ETSI EN 301 489-3 V2.1.1:2019-03 art.3.1 b Electromagnetic compatibility

ETSI EN 300 220-2 V3.2.1 (2018-06) art.3.2 Effective and coherent use of radio spectrum

ETSI EN 300 220-1 V3.1.1 (2017-02) art.3.2 Effective and coherent use of radio spectrum

PN EN IEC 63000:2019-01 RoHS

Wieprz, 22.07.2020

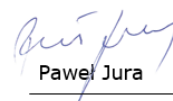
  
Paweł Jura

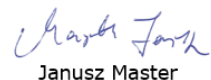
  
Janusz Master

Prezisi firmy



**TECH  
TECH  
CONTROLLERS**

**Central headquarters:**

ul. Biała Droga 31, 34-122 Wieprz

**Service:**

ul. Skotnica 120, 32-652 Bulowice

phone: **+48 33 875 93 80**

e-mail: **serwis@techsterowniki.pl**