

TECH TECH CONTROLLERS

USER MANUAL

EU-580 zPID

EN



www.tech-controllers.com

Table of contents

I. Safety 4

II. Description of the device 5

III. Installation 5

IV. How to use the controller 7

 IV.1. Principle of operation 7

 IV.2. Stages of operation 7

 IV.3. zPID control 7

 IV.4. Controller operation without zPID control 8

 IV.5. How to navigate..... 9

V. Controller functions– main menu 9

 V.1. Block diagram of the main menu..... 9

 V.2. Fire-up..... 11

 V.3. Screen view..... 11

 V.4. Fuel tank full 11

 V.5. Temperature settings 11

 V.5.a) Pre-set CH temperature 11

 V.5.b) CH hysteresis 11

 V.5.c) Pre-set DHW temperature 11

 V.5.d) DHW hysteresis 11

 V.5.e) Temperature of pump activation..... 11

 V.5.f) Pre-set room temperature 12

 V.6. Manual mode 12

 V.7. Operation settings..... 12

 V.7.a) Feeding time 12

 V.7.b) Pause time 12

 V.7.c) Blow force..... 12

 V.7.d) Operation in sustain mode 12

 V.7.e) Pause in sustain mode 12

 V.7.f) Fan in sustain mode 12

 V.7.g) Fan speed in sustain mode 12

 V.8. Fuel granulation 12

 V.9. Operation modes..... 13

 V.9.a) House heating 13

 V.9.b) Water tank priority 13

 V.9.c) Parallel pumps 13

 V.9.d) Summer mode..... 13

 V.10. Weekly control 13

 V.11. Operation algorithm selection 14

 V.12. Fitter's menu 14

 V.13. Service menu 14

 V.14. Software version 14

 V.14.a) Software update 15

 V.15. Factory settings 15

VI.	Controller functions - Fitter's menu.....	15
VI.1.	PID coefficient	16
VI.1.a)	CH boiler power coefficient.....	17
VI.1.b)	Fan correction bottom / Fan correction top	17
VI.2.	PID supervision.....	17
VI.3.	Buffer parameters	17
VI.3.a)	Buffer.....	17
VI.3.b)	DHW function	17
VI.3.c)	Pre-set temperature top.....	17
VI.3.d)	Pre-set temperature bottom	17
VI.4.	Valve settings.....	18
VI.4.a)	Built-in valve, Additional valve 1 and 2	18
VI.5.	Additional pump 1 / Additional pump 2	22
VI.5.a)	Algorithm selection	22
VI.5.b)	Short circuit pump	22
VI.5.c)	Floor pump	22
VI.5.d)	Circulating pump.....	22
VI.6.	Time settings.....	22
VI.7.	Date settings.....	22
VI.8.	Internet module.....	23
VI.9.	Fuel level calibration	23
VI.10.	Language	23
VI.11.	Room regulator.....	23
VI.12.	External temperature correction.....	24
VI.13.	GSM module.....	24
VI.14.	Factory settings	24
VII.	Protections	24
VII.1.	Temperature alarm.....	24
VII.2.	Thermal protection of CH boiler (STB)	24
VII.3.	Automatic sensor control.....	24
VII.4.	Protection against boiling of water in the CH boiler.....	25
VII.5.	Temperature protection.....	25
VII.6.	Fuel feeder protection.....	25
VII.7.	Fuse	25
VIII.	Maintenance.....	25

I. Safety

Before using the device for the first time the user should read the following regulations carefully. Not obeying the rules included in this manual may lead to personal injuries or controller damage. The user's manual should be stored in a safe place for further reference. In order to avoid accidents and errors it should be ensured that every person using the device has familiarized themselves with the principle of operation as well as security functions of the controller. If the device is to be sold or put in a different place, make sure that the user's manual is there with the device so that any potential user has access to essential information about the device.

The manufacturer does not accept responsibility for any injuries or damage resulting from negligence; therefore, users are obliged to take the necessary safety measures listed in this manual to protect their lives and property.



WARNING

- **High voltage!** Make sure the regulator is disconnected from the mains before performing any activities involving the power supply (plugging cables, installing the device etc.)
 - The device should be installed by a qualified electrician.
- Before starting the controller, the user should measure earthing resistance of the electric motors as well as the insulation resistance of the cables.
 - The regulator should not be operated by children.



WARNING

- The device may be damaged if struck by a lightning. Make sure the plug is disconnected from the power supply during storm.
 - Any use other than specified by the manufacturer is forbidden.
- Before and during the heating season, the controller should be checked for condition of its cables. The user should also check if the controller is properly mounted and clean it if dusty or dirty.

Changes in the merchandise described in the manual may have been introduced subsequent to its completion on July 14th, 2022. The manufacturer retains the right to introduce changes to the structure. The illustrations may include additional equipment. Print technology may result in differences in colours shown.



We are committed to protecting the environment. Manufacturing electronic devices imposes an obligation of providing for environmentally safe disposal of used electronic components and devices. Hence, we have been entered into a register kept by the Inspection For Environmental Protection. The crossed-out bin symbol on a product means that the product may not be disposed of to household waste containers. Recycling of wastes helps to protect the environment. The user is obliged to transfer their used equipment to a collection point where all electric and electronic components will be recycled.

II. Description of the device

ST-550zPID temperature regulator is intended to control CH boiler with a screw feeder. Due to its advanced software it offers a range of functions:

- Control of the fan and the feeder
- Control of CH pump
- Control of DHW pump
- Control of two additional pumps
- Control of the mixing valve actuator
- Possibility of connecting a room regulator with traditional or RS communication
- Possibility of connecting ST-65 GSM module
- Possibility of connecting the Internet module ST-505
- Possibility of controlling two valves via additional modules (e.g. i-1)

Controller equipment:

- CH temperature sensor
- Feeder temperature sensor (protection)
- Floor temperature sensor
- DHW sensor
- Temperature protection (bimetallic mini sensor)
- Supply cable
- Pump supply cables
- Hall-sensor of the fan

III. Installation

The controller should be installed by a qualified person.



WARNING

Risk of fatal electric shock from touching live connections. Before working on the controller switch off the power supply and prevent it from being accidentally switched on.



WARNING

Incorrect connection of the wires may lead to controller damage!

- 1. Thermal protector
- 2. CH sensor
- 3. Flue gas sensor
- 4. Feeder sensor
- 5. Fan hall.
- 6. Fan
- 7. Feeder
- 8. Valve
- 9. Room regulator
- 10. Valve sensor
- 11. Return sensor
- 12. External sensor
- 13. Floor sensor
- 14. DHW sensor
- 15. Add pump 2
- 16. Add pump 1
- 17. DHW pump
- 18. CH pump

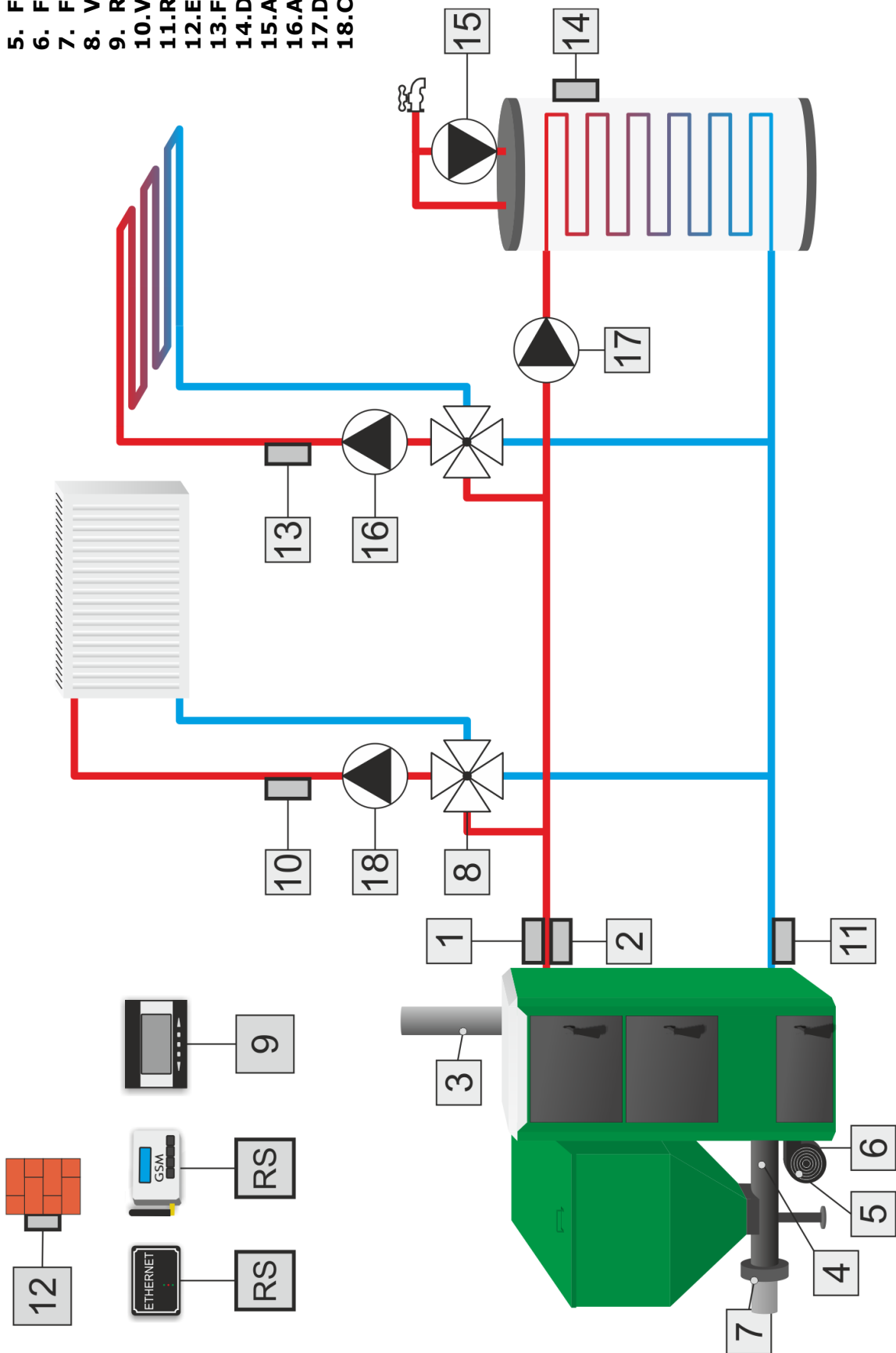

IV. How to use the controller

IV.1. Principle of operation

The regulator controls the fan and the fuel feeder operation so that the pre-set temperature of the CH boiler and the water tank is reached. Additionally, it controls CH and DHW pump operation activating them once a pre-defined temperature of the CH boiler has been reached.

IV.2. Stages of operation

Fire-up – this phase is initiated when the flue gas temperature reaches a pre-set value and does not drop below this value for 30seconds (default *fire-up time*).

Operation – when the fire-up phase has been completed, the controller enters operation mode and the display shows the message 'PID: OPERATION'. It is the primary mode of controller functioning when the blow force and fuel feeding are regulated with PID algorithm, oscillating around the pre-set temperature defined by the user. When the temperature increases unexpectedly by more than 5°C above the pre-set value, the *supervision mode* is activated.

Supervision mode – this mode is activated automatically when the temperature exceeds the pre-set value by more than 5°C in operation mode. In such a case, the controller disables PID control and uses manual settings (according to parameters defined in the fitter's menu).The display shows the following message: '**PID: SUPERVISION**'

IV.3. zPID control

EU-580 zPID is a controller with continuous output signal, using **zPID algorithm**. This type of controller calculates the blow force on the basis of CH boiler temperature and the flue gas temperature measured at the CH boiler outlet. The fan operates continuously and the blow force depends on the CH boiler temperature, the flue gas temperature as well as the difference between these parameters and their pre-set values. One of the greatest advantages of zPID regulators is their ability to maintain a stable pre-set temperature without unnecessary overregulation and oscillations.

Apart from zPID control, the controller operation is adjusted on the basis of the the readings from the air flow sensor mounted on the fan.

Using this type of regulator with a flue gas sensor helps to reduce fuel costs by up to several percent. Moreover, it ensures stable temperature of output water thus prolonging the life of the heat exchanger (of the CH boiler). Flue gas temperature control results in low emission of dust and environmentally harmful gases. Flue gas heat is not disposed of through the chimney, but it is utilised for heating purposes.

TEST RESULTS - TECH controller with PID control:

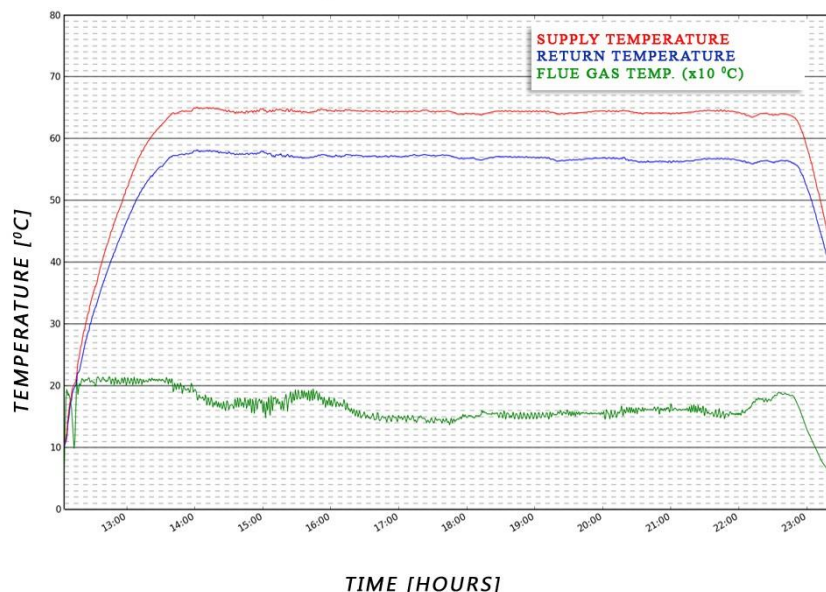

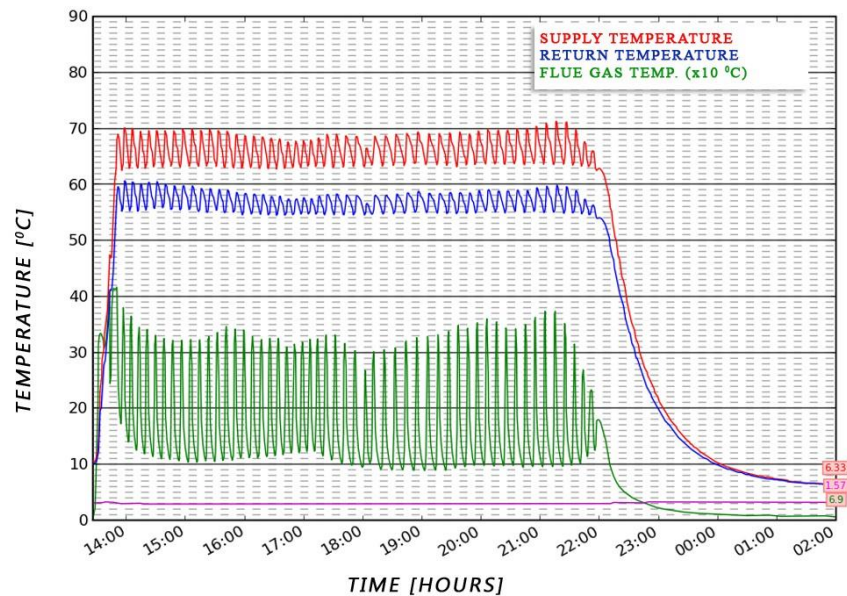
TEST RESULTS - TECH controller without PID control:**IV.4. Controller operation without zPID control**

zPID control may be disabled at any time using *Operation algorithm selection* parameter. Additional submenu will appear in the controller menu, allowing the user to configure boiler operation parameters.

Once zPID control is disabled, the principle of operation is changed - after the fire-up stage the controller enters operation mode which is followed by sustain mode:

Operation – once the controller is switched on, it enters operation mode and *OPERATION* appears on the display. It is the primary mode of controller operation in which the fan operates continuously and the fuel feeder operation is adjusted according to user's settings. The user defines both the operation time and pause time.

Sustain mode – this mode is activated automatically if the temperature is equal or higher than the pre-set temperature value. Fuel feeding process slows down in order to smoothly reduce the temperature of the circulating water. *SUSTAIN* appears on the display. In order for the temperature to decrease properly, it is necessary to configure operation and pause time in sustain mode as well as the fan speed.

IV.5. How to navigate

During standard operation of the controller, **graphic** display shows *the main page*.

By pressing **MENU** button the user enters the first level menu. In order to move on to the next option, twist the pulser knob. Press the knob to select an option. Follow a similar procedure when adjusting parameters. In order for the changes to be saved, use the pulser knob to select **CONFIRM**. In order not to introduce any changes, use the pulser knob to select **CANCEL**. In order to leave the menu, use **EXIT** button.

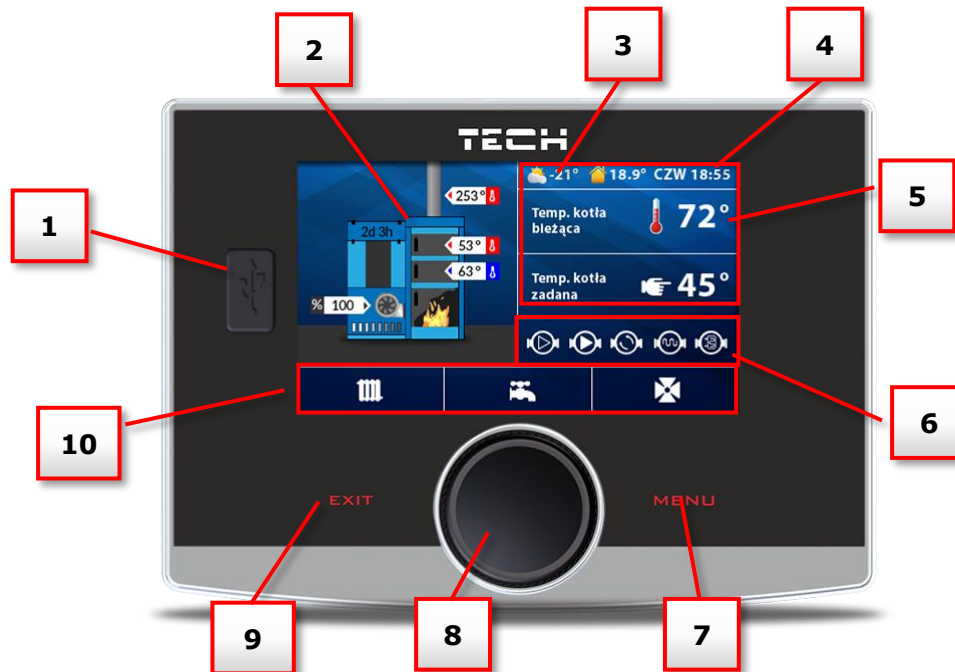

1. USB port
2. Panel showing current parameters of the sensors and the fan
3. CH boiler operation stage
4. Current time
5. Right parameter panel – use pulser knob to switch between CH boiler parameters and DHW or valve parameters (if activated).
6. Operation status bar - it displays icons indicating all devices which are currently active:
 - fan and its speed (%); if Hall sensor of the fan is active, letter H is displayed;
 - feeder; if *burning without feeder* option is active, a crossed out feeder icon is displayed.
 - CH pump
 - DHW pump
 - additional pump 1
7. Enter the controller menu. While viewing the controller functions use this button to return to the main screen view.
8. Pulser knob. Twist the knob in the main screen view to change the parameter view or press it to edit the selected parameter. While viewing the menu options use the knob to move on to the next function or configure CH boiler operation parameters.
9. EXIT button
10. Active operation panel bar:
 - CH boiler
 - DHW
 - built-in valve (if switched on)
 - additional valves (if switched on; additional valve modules e.g. i-1 are required).

V. Controller functions– main menu

V.1. Block diagram of the main menu.

Due to multiple functions offered by the controller, the menu is divided into Main Menu and Fitter's Menu. The main menu allows the user to set the basic controller options such as pre-set temperature values, operation modes, screen view etc.

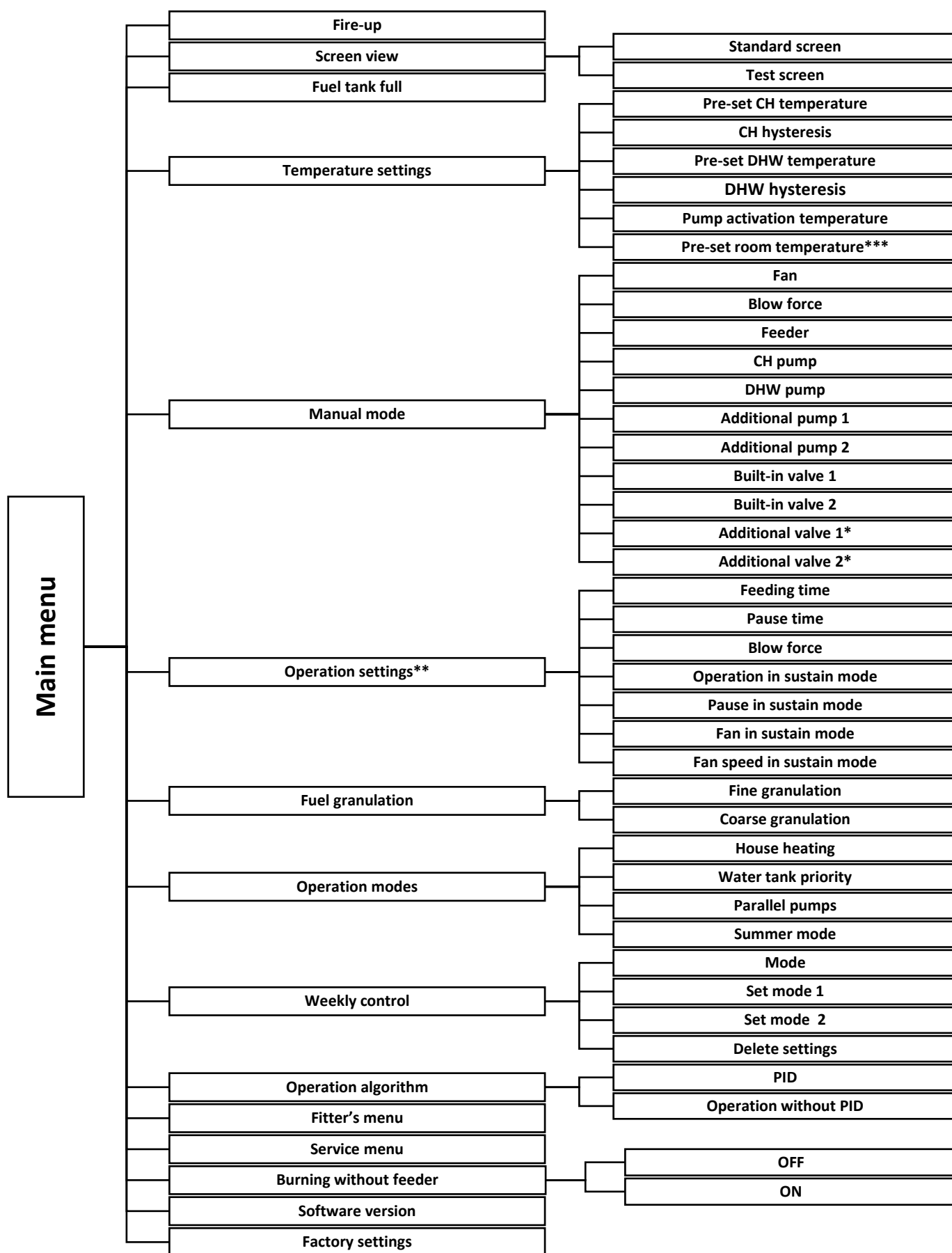

*Parameters available in the controller menu only if the additional valve module has been connected and module registration process has been completed in the additional valve menu.

**Submenu available only if *Operation without PID* is selected.

***Parameter available only if TECH room regulator with RS communication has been connected and activated.

V.2. Fire-up

This function enables the user to easily fire-up the CH boiler. After initiating the fire manually (preparing the furnace and starting the fire), the user activates automatic fire-up phase in the controller menu. The controller conducts the fire-up process maintaining the blow and gradually feeding fuel. Thanks to optimum parameters, CH boiler smoothly switches to operation mode.

Once the CH boiler entered operation mode, instead of *Fire-up* function the menu displays *Damping* function, which may be used to activate damping process.

V.3. Screen view

This function is used to choose between standard screen view and test screen view (secured with a code).

V.4. Fuel tank full

This function should be used after the fuel tank has been fully filled, in order to reset the fuel consumption percentage to 100% (the value displayed in the top right-hand corner of the main screen, below the clock).



NOTE:

Before using this function for the first time it is necessary to calibrate the fuel feeder operation in the fitter's menu.

V.5. Temperature settings

V.5.a) Pre-set CH temperature

This option is used to define the pre-set CH boiler temperature. The setting range is 45°C do 80°C.

The pre-set temperature may also be changed with the use of weekly control function. The pre-set temperature is the sum of all these values but within the range of 45°C do 80°C.

V.5.b) CH hysteresis

This option is used to set the hysteresis of the pre-set temperature. It is the difference between the temperature of entering the sustain mode and the temperature of restoring operation mode (for example: when the pre-set temperature is 60 °C, the hysteresis is 3°C, entering sustain mode takes place at the temperature of 60 °C whereas returning to the operation mode takes place at 57 °C).

V.5.c) Pre-set DHW temperature

This function is used to define the pre-set temperature of the domestic water (this function is inactive when *house heating* mode is selected). This value may be adjusted directly from the main screen view. After the tank water reaches this temperature, DHW pump is disabled. The pump will be enabled again when the temperature drops below the pre-set temperature by a pre-defined value.

V.5.d) DHW hysteresis

This option is used to set the hysteresis of the pre-set water tank temperature. It is the difference between the pre-set temperature (desired temp. of the water tank when DHW pump is switched off) and the temperature at which DHW pump is activated again (for example: when the pre-set temperature is 55 °C, the hysteresis is 5°C, DHW pump is switched off and CH pump is enabled when the pre-set temperature of 55 °C is reached. DHW pump is activated again when the temperature drops to 50 °C).

V.5.e) Temperature of pump activation

This option is used to define the temperature of CH pump and DHW pump activation (temperature measured on the CH boiler). Below this temperature value both pumps remain inactive whereas above this value the pumps are enabled and operate according to the operation mode (see: pump operation modes).

V.5.f) Pre-set room temperature

Once a room regulator with RS communication has been connected and activated in the controller menu (*Fitter's menu/Room regulator*), the user may adjust the pre-set room temperature.

V.6. Manual mode

For the user's convenience, the regulator offers manual mode function. In this function, each executive device may be activated and deactivated independently of others. It is an easy way of checking if the following devices work properly: feeder, blow (fan), CH pump, DHW pump, additional pump 1, additional pump 2, built-in valve1, valve 1, valve 2). Additionally, the user may adjust the fan speed in manual operation mode using blow force function.

V.7. Operation settings



NOTE: This submenu is available only when PID control is disabled - see: *Controller operation without zPID control*.

V.7.a) Feeding time

This option is used to set the operation time of the fuel feeder. It should be adjusted to the type of fuel and CH boiler used.

V.7.b) Pause time

This option is used to set the pause time of the feeder. The length of the pause should be adjusted to the type of fuel used.

Incorrect pause time may result in inefficient operation of the CH boiler, i.e. unburnt coal left or failure to reach the pre-set temperature of the CH boiler. Appropriate pause time ensures efficient operation of the CH boiler.

V.7.c) Blow force

This function is used to control the fan speed. The setting range is 1-100% (it may be regarded as fan gears). The higher the gear is, the faster the fan works. 10% is the minimum fan speed whereas 100% is the maximum fan speed.

Initially the fan always operates at a full speed, which enables successful activation even if the motor is dusty.

V.7.d) Operation in sustain mode

This option is used to set the operation time of the feeder and the fan when the CH boiler operates in sustain mode.

V.7.e) Pause in sustain mode

This option is used to set the fuel feeding pause time when the CH boiler operates in sustain mode. Incorrect setting of pause and operation time may result in further temperature increase, unintended CH boiler damping or lead to fuel ignition hazard in the fuel tank.

V.7.f) Fan in sustain mode

This option is used to set the fan operation and pause time in sustain mode.

V.7.g) Fan speed in sustain mode

This option is used to set appropriate fan gear (blow force) in sustain mode.

V.8. Fuel granulation

This function is used to choose one of the two levels of fuel granulation: coarse or fine. For each level there is suitable blow force and fuel feeding frequency programmed.

V.9. Operation modes

V.9.a) House heating

When this function is selected, only the house is heated. CH pump is activated when the temperature is above the pump activation threshold (factory setting). Below this temperature value (minus 2°C – *hysteresis*) the pump is disabled.

V.9.b) Water tank priority

In this mode, the DHW pump is activated first and it operates until the pre-set DHW temperature is reached. After the pre-set temperature has been reached, the pump is switched off and the CH pump is activated.

CH pump operates continuously until the water tank temperature drops below the pre-set value minus *DHW hysteresis*. Then, the CH pump is disabled and the DHW pump is activated.

In this mode, the fan and the feeder operation is limited to 72 °C at the CH boiler in order to prevent the CH boiler from overheating.



WARNING:

Return valves should be installed on the circuits of the CH and DHW pumps. The valve on DHW pump prevents hot water from being sucked out of the water tank.

V.9.c) Parallel pumps

In this mode, both pumps are activated simultaneously above the pre-set activation temperature (default setting: 40 °C).

CH pump operates all the time whereas DHW pump is disabled when the pre-set water tank temperature is reached.

V.9.d) Summer mode

In this mode, CH pump is switched off and DHW pump is enabled above the pump activation threshold (default setting: 40°C) and operates all the time above this threshold.

In summer mode the user defines only the pre-set temperature of the CH boiler which heats the domestic hot water (this value also serves as the pre-set water tank temperature). After this function has been activated, the screen displays current CH temperature and two DHW temperature values (the current temperature value and the pre-set one).

V.10. Weekly control

Weekly control function enables the user to program changes of the pre-set CH boiler temperature (CH weekly control) or water tank temperature (DHW weekly control) for particular hours and days of the week.

In order to activate this function, select mode 1 or mode 2. Detailed settings of each mode are available further in the submenu: *Set mode 1* and *Set mode 2*.

Once a given mode is selected, the main screen displays the value of current temperature deviation (below the pre-set CH temperature, alternately with *Pre-set*) informing the user that the function is active.

How to change weekly control settings:

EU-580 zPID controller enables the user to program weekly control function in two modes:

MODE 1 – the user sets the temperature deviations for each day of the week separately;

MODE 2 – the user sets the temperature deviations for all working days (Monday-Friday) and for the weekend (Saturday-Sunday) separately.

How to configure mode 1:

In order to configure mode 1, select *Set mode 1* – the display shows the panel with particular days of the week.

Once a given day of the week is selected, the screen shows the editing panel – the upper line shows current deviation, the lower line shows the time period. Twist the pulser knob to change the time period. In order to edit the deviation value, press the pulser knob and select *Change*.

In order to copy the setting for the next time period, press the pulser knob and select *Copy*.

Example:

Monday

set: 3⁰⁰ AM, temp -10⁰C (weekly control setting- 10⁰C)

set: 4⁰⁰ AM, temp -10⁰C (weekly control setting- 10⁰C)

set: 5⁰⁰ AM, temp -10⁰C (weekly control setting- 10⁰C)

In this case, if the pre-set temperature of the CH boiler is 60⁰C, from 3⁰⁰ AM to 6⁰⁰ AM on Monday the pre-set temperature will drop by 10⁰C, so it will be 50⁰C.

How to configure mode 2:

In order to configure mode 2, select *Set mode 2* – the display shows a panel with two day groups – Monday-Friday and Saturday-Sunday. Select the group to be edited and follow the same procedure as with mode 1.

Example:

Monday-Friday

set: 3⁰⁰ AM, temp -10⁰C (weekly control setting – 10⁰C)

set: 4⁰⁰ AM, temp -10⁰C (weekly control setting – 10⁰C)

set: 5⁰⁰ AM, temp -10⁰C (weekly control setting – 10⁰C)

Saturday-Sunday

set: 4⁰⁰ PM, temp 5⁰C (weekly control setting +5⁰C)

set: 5⁰⁰ PM, temp 5⁰C (weekly control setting +5⁰C)

set: 6⁰⁰ PM, temp 5⁰C (weekly control setting +5⁰C)

In this case, if the pre-set temperature of the CH boiler is 60⁰C, on each weekday (Monday – Friday) from 3⁰⁰AM to 6⁰⁰AM the pre-set temperature will drop by 10⁰C, so it will be 50⁰C. During the weekend, from 4⁰⁰ PM to 7⁰⁰ PM the pre-set temperature of the CH boiler will increase by 5⁰C, so it will be 65⁰C.



NOTE

In order for the weekly control to function properly it is necessary to set current time and day of the week in Fitter's menu >> Clock.

Delete data

This function enables the user to delete all weekly control settings.

V.11. Operation algorithm selection

This function is used to select the operation algorithm. If the user does not want to use zPID control function, it may be disabled by selecting *Operation without PID*.

V.12. Fitter's menu

Functions available in this menu are described in detail in the following sections of this manual.

V.13. Service menu

In order to enter the service menu of EU-580zPID controller, it is necessary to enter a 4-digit code provided by TECH company staff.

V.14. Software version

This function is used to check the software version used in the controller. Twist the pulser knob to view the software version of additional modules controlling the valve.

V.14.a) Software update



- Software update should be conducted when the CH boiler is damped.
- The memory stick which is going to be used to save the set-up file should be empty (preferably formatted)
- Make sure that the file saved on the memory stick has exactly the same name as the downloaded file so that it is not overwritten.

- ⇒ Insert the memory stick with the software into the controller USB port.
- ⇒ Reset the device by unplugging it and plugging it back in.
- ⇒ When the controller starts again, wait until the software update process starts.
 - Once restarted, the controller display shows the starting screen.
 - Software update starts automatically.
 - During installation process colourful stripes appear on the screen illustrating the installation progress.
 - Once the installation process is completed, the display shows the main screen.
- ⇒ Once the software update has been completed, you must remove the memory stick from the USB port.

V.15. Factory settings

The controller is pre-configured for operation. However, the settings should be customized to the user's needs. Return to factory settings is possible at any time. When the factory settings option is activated, all customized settings of the CH boiler (saved in the user's menu) are lost and replaced with the manufacturer's settings. Then, the parameters may be customized anew.

VI. Controller functions - Fitter's menu

Fitter's menu should be accessed by a qualified person. It is used to configure additional functions of the controller such as CH boiler parameters, additional valves, additional pumps etc. as well as advanced settings of basic functions (such as built-in valve parameters).

Block diagram of fitter's menu is presented below:

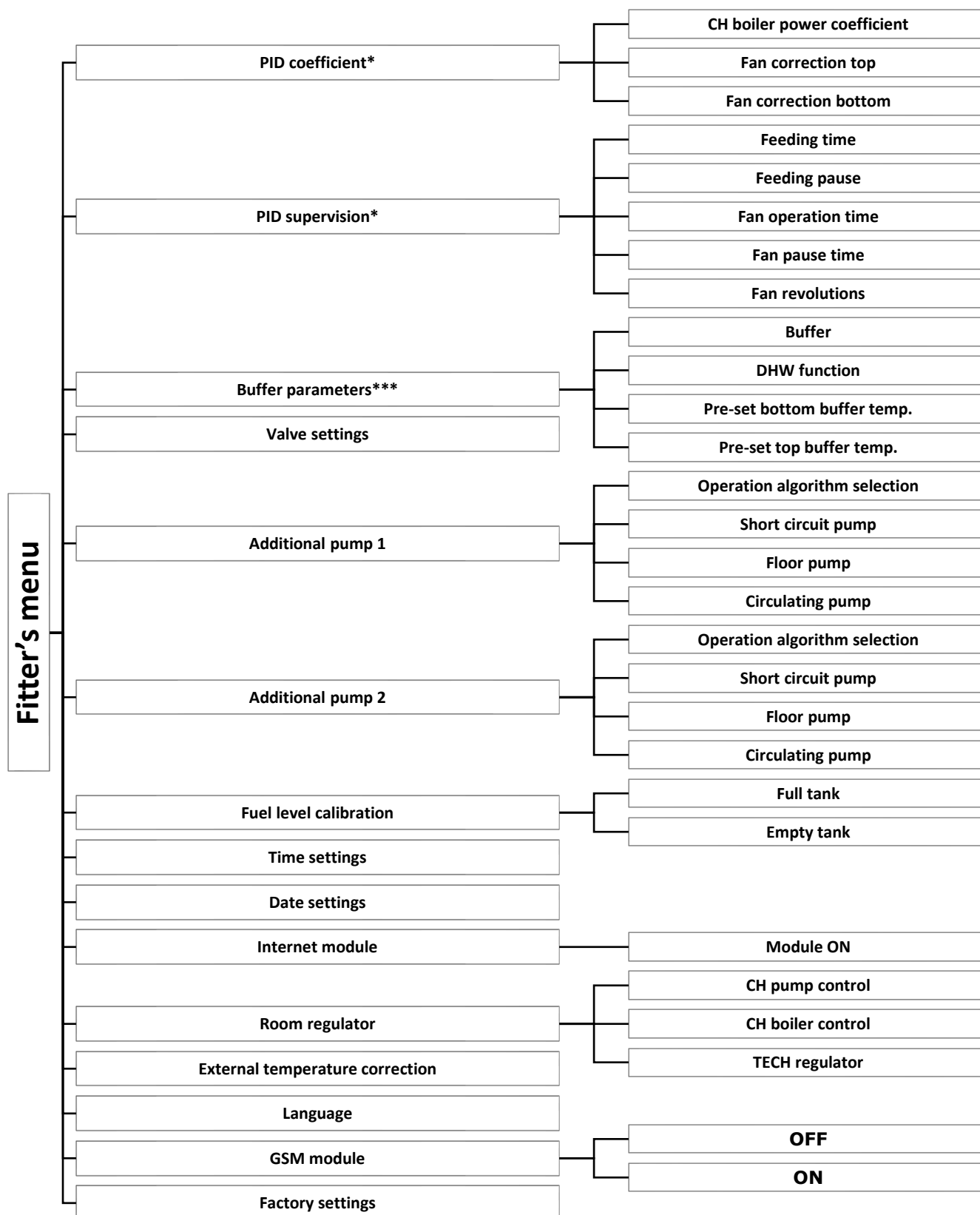

*Submenu available only when *Operation with zPID control* is selected

**Submenu available only when *Operation without zPID control* is selected

VI.1. PID coefficient



NOTE

This submenu concerns CH boiler operation with PID control and it is available only when zPID control is active.

VI.1.a) CH boiler power coefficient

CH boiler power coefficient serves to control the feeder and fan operation at the same time. 100% is the default value but it may be adjusted within the range of 50-110%. Once a change is introduced, the upper limit of zPID parameters is moved (operation/pause time of the feeder and blow force). The lower limit of parameters remains unchanged.

VI.1.b) Fan correction bottom / Fan correction top

This function is used to adjust the fan speed. If the blow force is too low/high, the coefficient should be adequately increased/decreased in order to ensure efficiency.

The user may adjust the fan speed for both minimum and maximum CH boiler power indicated by zPID (*Fan correction bottom* and *Fan correction top* parameters).

VI.2. PID supervision



NOTE

This submenu concerns CH boiler operation with PID control and it is available only when zPID control is active.

In this function the user configures the combustion parameters for the situation when the CH boiler temperature exceeds the pre-set value by 5°C.

VI.3. Buffer parameters

These parameters enable the user to configure controller operation settings in the case of heating systems with a buffer.

VI.3.a) Buffer

Once buffer function is activated (by selecting ON), CH pump serves as pump of the buffer in which two sensors are installed: upper (C1) and lower (C2). The pump remains active until the pre-set temperature of buffer bottom is reached. When the temperature drops below the pre-set buffer top temperature, the pump is activated again.

VI.3.b) DHW function

If buffer is used in the heating system, it is necessary to specify how the water tank is connected:

- from CH boiler – the heating system in which DHW tank is connected directly to the CH boiler (a separate circuit).
- from buffer – the heating system in which DHW tank is built in or connected to the buffer.

VI.3.c) Pre-set temperature top

This function enables the user to define the pre-set temperature for the upper part of the buffer (sensor should be placed in the upper part of the tank). After this value is reached, the pump is disabled (provided that the pre-set buffer temperature bottom has also been reached).

VI.3.d) Pre-set temperature bottom

This function enables the user to define the pre-set temperature for the lower part of the buffer (sensor should be placed in the lower part of the tank).

VI.4. Valve settings

VI.4.a) Built-in valve, Additional valve 1 and 2

These options are used to configure operation of the built-in valve. The built-in module controls two valves without the need to use additional devices. If the heating system requires other devices, an additional module controlling the valve (e.g.i-1) may be connected to the EU-580 zPID controller. The parameters included in the submenus Valve 1 and Valve 2 are intended for controlling such valves. In the case of valves 1 and 2, it is necessary to register in order for the valve to operate correctly. To register the valve, enter the module number (placed on the casing) and configure a few parameters. There is a range of parameters intended for configuring the operation of the valves and adjusting it to the user's needs. Both the parameters of the built-in valve and the parameters of the valves are similar, which is illustrated by the following block diagrams:

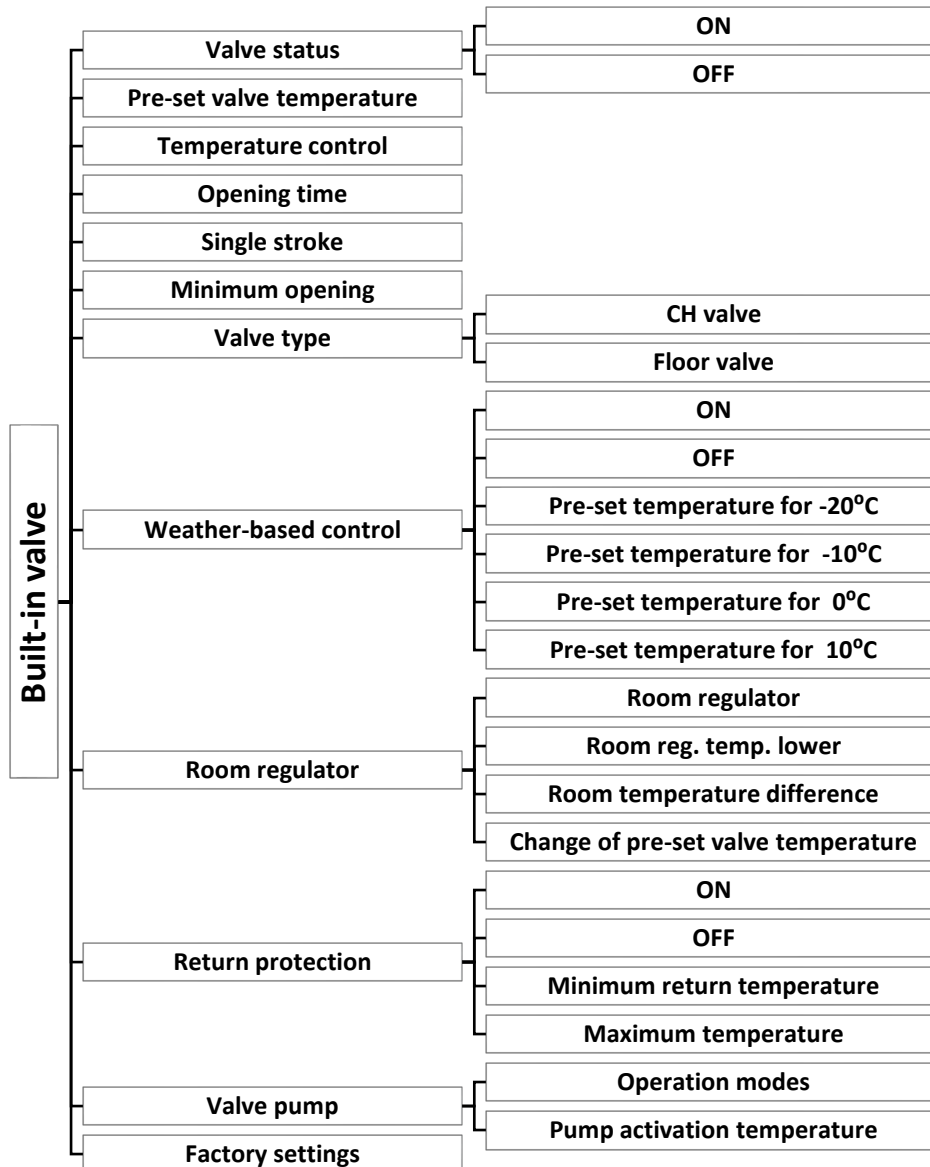

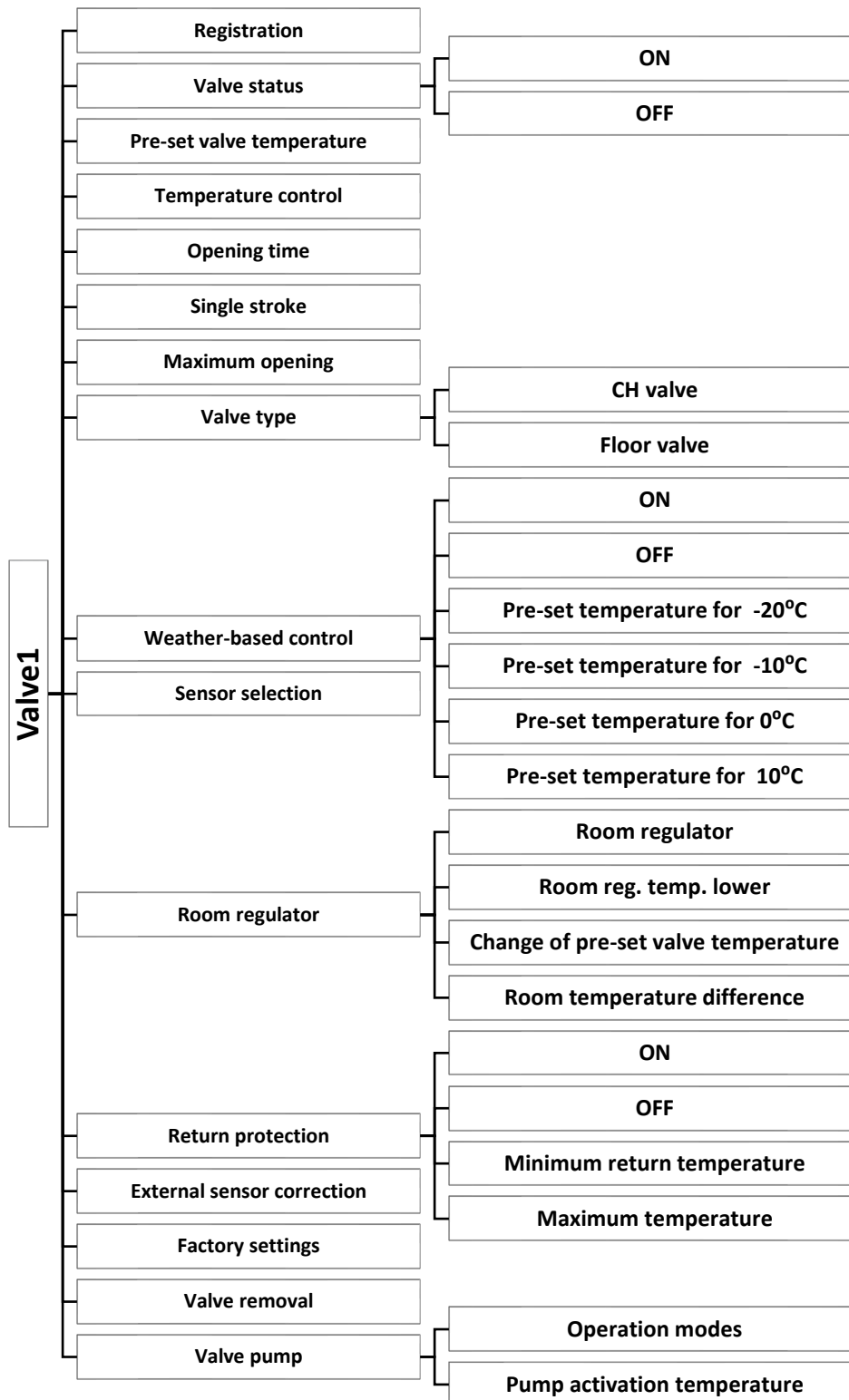

Registration

Option available only for valve.

This function is used by the fitter to enter the serial number of the module controlling the three-way valve actuator (a 5-digit number given on the module casing). Without this number the function remains inactive.

Valve status

This function allows the user to deactivate the valve temporarily without the need to remove it altogether. After re-activating the valve, it is not necessary to register again.

Pre-set valve temperature

This function is used to define the pre-set temperature of the valve. The setting range differs depending on the valve type. The pre-set temperature value may be adjusted directly from the main screen view by twisting the pulser knob.

Temperature control

This parameter determines the frequency of water temperature measurement (control) behind the CH or DHW valve. If the sensor indicates a change in temperature (deviation from the set value), then the electric valve will open or close by the set stroke, in order to return to the pre-set temperature.

Opening time

This parameter defines the time needed for the valve actuator to open the valve from 0% to 100% position. This value should be adjusted to the value given on the actuator rating plate.

Single stroke

This function is used to define the maximum single stroke (opening or closing) that the valve may make during one temperature sampling.

Minimum opening

This function is used to set the minimum value of valve opening. The valve does not close any further.

Valve type

This option is used to select the type of valve used.

Weather-based control

For the function of weather control to be active, the external sensor mustn't be exposed to sunlight or influenced by the weather conditions.

After it is installed in an appropriate place, weather-based control function needs to be activated in the controller menu.

For the valve to operate correctly, the user defines the pre-set temperature (behind the valve) for 4 intermediate external temperatures:

TEMP FOR -20°C
 TEMP FOR -10°C
 TEMP FOR 0°C
 TEMP FOR 10°C

Heating curve – it is a curve according to which the pre-set controller temperature is determined, on the basis of external temperature. In our controller, this curve is constructed on the basis of four pre-set temperatures for respective values of external temperatures.

The more points constructing the curve, the greater its accuracy, which allows its flexible shaping. In our opinion, four points seem a very good compromise ensuring decent accuracy and easiness of setting the course of this curve.

In our controller:

$X_A = -20^\circ\text{C}$, $X_C = 0^\circ\text{C}$,

$X_B = -10^\circ\text{C}$, $X_D = 10^\circ\text{C}$,

Y_A, Y_B, Y_C, Y_D – pre-set temperatures of the valve for respective external temperatures: X_A, X_B, X_C, X_D

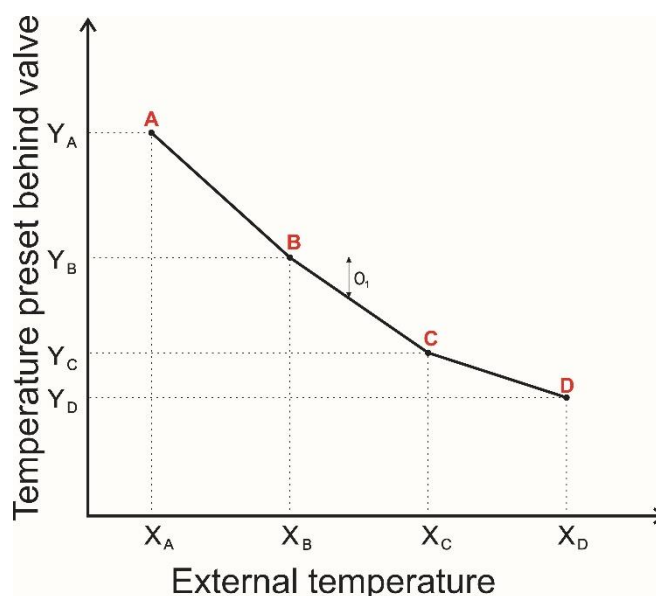

After weather-based control function has been activated, *pre-set valve temperature* function is no longer available.

Return protection

This function enables the user to set CH boiler protection against too cool water returning from the main circulation, which could cause low-temperature CH boiler corrosion. The return protection involves closing the valve when the temperature is too low, until the short circulation of the boiler reaches the appropriate temperature. This function also protects the CH boiler against too high temperature by preventing the returning water from boiling.

After activating it, the user pre-sets the minimum and the maximum acceptable return.

Sensor selection

Option available only for valve 1 and valve 2.

When two mixing valves are used, this option enables the user to specify which sensors should be used to provide temperature data for the valve (for external temperature sensor and return sensor). The temperature values may be read from the sensors of the selected valve (Own) or valve 2 sensors (module2).

Room regulator

This option is used to define how the room regulator settings will influence particular valve status.

Room regulator – the user should select the type of a room regulator cooperating with the valve. The following options are available:

- *OFF* – room regulator status does not influence valve settings;
- *TECH regulator*– a regulator with RS communication;
- *Proportional regulation* – option available only with TECH regulators offering RS communication function. It is necessary to configure two options: change of pre-set valve temp. and room temperature difference.

Room reg. temp. lower - When the room regulator reaches the pre-set temperature, the pre-set valve temperature drops by the value defined in this parameter.(Option unavailable when *Proportional regulation* is selected.)

Change of pre-set valve temperature – This setting determines by how many degrees the valve temperature is to increase or decrease with a single unit change in room temperature (see: Room temperature difference). This function is active only with TECH room regulator and it is closely related to the Room temperature difference parameter.

Room temperature difference - This setting is used to define the single unit change in the current room temperature (with the accuracy of 0.1°C) at which a predefined change in the set temperature of the valve will be introduced (function available only with TECH room regulator).

Maximum floor temperature

This function is used to define the maximum temperature of the valve sensor which does not damage the underfloor heating system. It is used when *floor valve* is selected as the valve type. Once this temperature is reached, an alarm is activated and the valve is closed completely. When maximum floor temperature is reached, CH boiler protection function is deactivated. In such a case, protection of the underfloor heating system is given a higher priority.

External temperature correction

Option available only for additional valves 1 and 2.

This function is used to calibrate the external temperature sensor.

Factory settings

This function enables the user to restore the factory settings for a particular valve. Restoring factory settings does not change the selected valve type (CH or floor).

Valve removal

Function available only for additional valves 1 and 2.

This option is used to remove the valve from the controller memory. *Valve removal* is used e.g. at disassembling the valve or module replacement (re-registration of a new module is necessary).

Valve pump

This option enables the user to select the working mode of the pump out of the following:

- **always ON** - the pump operates all the time, regardless of temperatures,
- **Never**- the pump is permanently deactivated and the regulator controls only the valve operation,

- **ON above the threshold** - the pump is activated above the pre-set *switch on temperature*.

In the case of additional valves, these settings concern the pump connected to the valve module (e.g. i-1). In the case of a built-in valve, these settings concern the additional pump which has been assigned *Valve pump* operation algorithm.

VI.5. Additional pump 1 / Additional pump 2

These submenus enable the user to select the type of additional pump connected to the additional pump contact (*Operation algorithm selection*) and configure its operating parameters.

VI.5.a) Algorithm selection

Once the additional pump has been connected, the user selects its type in *Algorithm selection* parameter. If *valve pump* is selected, the pump operates according to the parameters configured in the built-in valve submenu (see: previous section).

If the additional pump is to serve as short circuit pump or floor pump, it is necessary to configure its operation in the following submenus.

VI.5.b) Short circuit pump

When short circuit pump is selected, the user can adjust the pump operation to individual needs using the parameters available in *CH boiler protection pump* submenu.

The additional pump which serves as a short circuit pump is activated when the CH boiler temperature reaches the user-defined threshold value – *Pump activation temperature* (measured at CH sensor). The pump remains active until the temperature drops below the pre-set value by hysteresis value.

If other sensor is to serve as CH sensor, it must be selected in *CH sensor* parameter.

VI.5.c) Floor pump

If floor pump is selected, the user can adjust the pump operation to individual needs using the parameters available in *Floor pump* submenu.

Once the pump is activated (switched on), the user sets the minimum (threshold) temperature of pump activation (measured by CH sensor) and the maximum (pre-set) temperature of the underfloor heating system (measured by the floor sensor, within the range of 25°C – 55°C).

Below the minimum temperature the pump remains inactive. Above this temperature the pump is enabled and it remains active until the maximum temperature is reached – then it is switched off. The pump is enabled again when the temperature drops by the value defined as *Hysteresis below pre-set*.

If other sensor is to serve as CH sensor or floor sensor, it must be selected in *CH sensor* parameter or *Floor sensor* parameter.

VI.5.d) Circulating pump

Once this option is selected, the additional pump serves as the circulating pump. The pump controls the valve which mixes the hot water between the CH boiler and the DHW receivers. The following parameters need to be configured for the circulating pump to work correctly:

Operation time

This parameter defines the time of pump operation during its activity.

Pause time

This parameter defines the frequency at which the circulating pump is enabled during its activity.

Operation schedule

The user may program a daily schedule of pump operation and inactivity, with the accuracy of 30 minutes. The pump is enabled at the frequency defined in *Pause time* parameter and remains active for the time defined as *Operation time*. For the user's convenience, it is possible to copy a given time setting.

VI.6. Time settings

This option is used to set current time.

VI.7. Date settings

This option is used to set current date.

VI.8. Internet module



NOTE

This type of control is available only after purchasing and connecting an additional controlling module **ST-505** which is not included in the standard controller set.

Internet module is a device enabling the user remote control of the CH boiler via the Internet at www.emodul.pl. The user controls the status of all CH boiler system devices on the home computer screen and the operation of each device is presented in the form of animation.

Apart from the possibility to view the temperature of every sensor, the user can change the set temperature values for both the pumps and the mixing valves etc.

The installation process is intuitive. Connect the module and go to Fitter's menu of the main controller to activate the Internet module (Menu>>Fitter's menu>>Internet module>>ON).

Once *Registration* option is selected, the device generates a code which must be entered on the website.



NOTE

The code is valid for 60 minutes. If the user fails to register on the website within this time, a new code must be generated.

Internet module parameters such as IP address, IP mask, gate address etc may be set manually or by selecting DHCP option.

VI.9. Fuel level calibration

These parameters are used to calibrate the fuel tank. Conducting fuel level calibration properly enables the user to view the current level of fuel on the controller screen. Such calibration is usually performed only once.

The first step involves filling the fuel tank up and selecting the option *Fuel tank full* (by pressing the pulser knob). The controller remembers the level as full (100%).

When there is no fuel left in the tank, the user should select the option *Fuel tank empty* (by pressing the pulser knob). In this way the fuel tank is properly calibrated.

Each time the tank is fully filled, a corresponding option should be selected in the menu so that the controller will automatically inform the user about the current fuel level.

VI.10. Language

This option is used to select the language version of the controller.

VI.11. Room regulator

This function enables the user to define the purpose of using the readings from the room regulator:

- **CH pump control** – the room regulator disables the CH pump when the pre-set temperature is reached. In this submenu the user specifies which room regulator will control the CH pump: TECH controller (room regulator with RS communication, connected to RS socket of EU-580 zPID controller) or standard regulator (a two-state room regulator).
- **CH boiler control** – when the pre-set room temperature has been reached, the pre-set CH boiler temperature is lowered by the value defined as *Room reg. temp. lower* parameter (the temperature does not drop below the minimum pre-set CH temperature). In this submenu the user specifies which room regulator will control the CH pump: TECH controller (room regulator with RS communication, connected to RS socket of EU-580 zPID controller) or standard regulator (a two-state room regulator).

EXAMPLE: Pre-set CH boiler temperature: 55°C

Room reg. temp. lower: 15°C

Minimum pre-set CH boiler temperature: 45°C (factory setting)

Once the pre-set room temperature is reached (signalled by the room regulator), the pre-set CH boiler temperature drops to 45°C, which is 10°C less although *room reg. temp. lower* parameter is 15°C. The main screen displays „!-10°” next to the pre-set CH boiler temperature.

TECH regulator

This function is used to establish communication with the room regulator with RS communication (connected to RS socket in EU-580 zPID controller). If this type of regulator is selected in *CH pump control* or *CH boiler control* submenu, the communication is activated automatically.

VI.12. External temperature correction

External sensor correction should be performed during installation or after a longer period of using the regulator when the temperature measured by the sensor is different from actual temperature. Range of regulation is -10 to +10 °C with the accuracy of 1°C.

VI.13. GSM module



NOTE

This type of control is available only after purchasing and connecting an additional controlling module ST-65 which is not included in the standard controller set.

GSM Module is an optional device which, cooperating with the controller, enables the user remote control of the CH boiler operation via mobile phone. The user is sent an SMS each time an alarm occurs. Moreover, after sending a certain text message, the user receives feedback on the current temperature of all the sensors. Remote change of the pre-set temperatures is also possible after the authorisation code is entered.

GSM Module may operate independently of the CH boiler controller. It has two additional inputs with temperature sensors, one contact input to be used in any configuration (detecting closing/opening of contacts) and one controlled output (e.g. a possibility of connecting an additional contractor to control any electric circuit).

When any of the temperature sensors reaches the preset maximum or minimum temperature, the module automatically sends an SMS message with such information.

A similar procedure is used in the case of opening or closing of the contact input, which may be used as a simple means of property protection.

If the GSM Module is to be used with the EU-580 zPID controller, it should be activated by selecting ON option (MENU>Fitter's menu>GSM Module>ON).

VI.14. Factory settings

This option is used to restore factory settings in the fitter's menu.

VII. Protections

In order to ensure safe and failure-free operation, the regulator has been equipped with a range of safeguards. In case of alarm, a sound signal is activated and the display shows an appropriate message. In order for the controller to return to the operation mode, press **pulsar knob**. In the event of '**CH temperature too high**' alarm, it is necessary to wait until the temperature drops below the alarm value.

VII.1. Temperature alarm

This protection is activated only in **operation mode** (when the CH boiler temperature is lower than the *pre-set temperature* value). If the CH boiler temperature does not increase within the period of time defined by the user, an alarm is activated: feeder and fan are switched off and a sound signal is activated. The display shows the following message: '**Temperature not rising**'.

Press the **pulsar knob** to deactivate the alarm. The controller will resume the previously selected operation mode.

VII.2. Thermal protection of CH boiler (STB)

EU-580 zPID controller is equipped with STB safety thermostat which protects the CH boiler against an excessive temperature increase. When the temperature reaches 95°C (default setting: STB 95°C), the contacts in the fan and feeder power supply circuit are opened. They may be activated again only manually by pressing 'reset' button on the safety thermostat casing after the CH boiler water cools down and reaches the temperature of about 80°C.

VII.3. Automatic sensor control

If one of the temperature sensors (CH, DHW, screw feeder or fuel tank) is damaged, an alarm sound is activated and the display message informs about the failure; e.g.: '**CH sensor damaged**'. Both the feeder and the fan are disabled. The pump operates regardless of current temperature.

If the CH sensor or feeder sensor is damaged, the alarm is active until a new sensor is installed. In the case of DHW sensor damage, the alarm should be switched off by pressing **pulsar knob** – the controller will restore operation with one pump (CH). A new sensor should be installed so that all modes of CH boiler operation could be available.

VII.4. Protection against boiling of water in the CH boiler

This protection applies only to *water boiler priority* mode, in the case when the water tank is not sufficiently heated. When the pre-set temperature of water tank is 55°C whereas the actual CH boiler temperature reaches 62°C (so called *priority temperature*), the controller disables the fan and the feeder. If the CH boiler temperature still increases reaching 80°C, the CH pump will be switched on. In the case of further temperature increase, an alarm will be activated at the temperature of 85°C. Such a situation usually occurs when the water boiler or the pump is damaged or when the sensor is incorrectly mounted. When the temperature drops, at 60°C the controller enables the fan and feeder and it remains in operation mode until the temperature of 62°C is reached.

VII.5. Temperature protection

The regulator has an additional protection against hazardous temperature growth. If the alarm temperature of 80°C is exceeded, the fan is disabled and the pumps are switched on in order to distribute hot water throughout the house installation. When the temperature of 85°C is exceeded, an alarm is activated and the display shows the following alarm message: '**Temperature too high**'. When the temperature drops to a safe level, press pulser knob to deactivate the alarm. The controller will resume the previous operation mode.

VII.6. Fuel feeder protection

There is an additional sensor measuring temperature on the screw feeder. In the event of a significant temperature increase (above 80°C), an alarm is activated: the feeder is for 10 minutes, which moves the fuel into the combustion chamber. Feeder sensor prevents the fuel in the tank from igniting.

VII.7. Fuse

The regulator has two WT 6.3A tube fuse-links protecting the network.



NOTE:

Higher amperage fuse should not be used as it may damage the controller

VIII. Maintenance

Before and during the heating season, **EU-580 zPID** controller should be checked for condition of its cables. The user should also check if the controller is properly mounted and clean it if dusty or dirty. It is advisable to measure earthing parameters for the motors (CH pump, DHW pump, fan, feeder and circulating pump).

No	Specification	Unit	
1	Supply voltage	V	230V/50Hz +/-10%
2	Maximum power consumption	W	11
3	Ambient temperature	°C	5÷50
4	Maximum output load of pumps: CH; DHW; Circulating; Valve	A	0,5
5	Output load of fan	A	0,6
6	Output load of fuel feeder	A	2
7	Range of temperature measurement	°C	0÷90
8	Accuracy of temperature measurement	°C	1
9	Range of temperature settings	°C	45÷80
10	Thermal resistance of the sensor	°C	-30÷99
11	Fuse	A	6,3



EU DECLARATION OF CONFORMITY

Hereby, we declare under our sole responsibility that **EU-580 zPID** manufactured by TECH STEROWNIKI, head-quartered in Wieprz Biała Droga 31, 34-122 Wieprz, is compliant with Directive **2014/35/EU** of the European Parliament and of the Council of 26 February 2014 on the harmonisation of the laws of Member States relating to **the making available on the market of electrical equipment designed for use within certain voltage limits** (EU OJ L 96, of 29.03.2014, p. 357), Directive **2014/30/EU** of the European Parliament and of the Council of 26 February 2014 on the harmonisation of the laws of Member States relating to **electromagnetic compatibility** (EU OJ L 96 of 29.03.2014, p.79), Directive **2009/125/EC** establishing a framework for the setting of ecodesign requirements for energy-related products as well as the regulation by the MINISTRY OF ENTREPRENEURSHIP AND TECHNOLOGY of 24 June 2019 amending the regulation concerning the essential requirements as regards the restriction of the use of certain hazardous substances in electrical and electronic equipment, implementing provisions of Directive (EU) 2017/2102 of the European Parliament and of the Council of 15 November 2017 amending Directive 2011/65/EU on the restriction of the use of certain hazardous substances in electrical and electronic equipment (OJ L 305, 21.11.2017, p. 8).

For compliance assessment, harmonized standards were used:

PN-EN IEC 60730-2-9:2019-06, PN-EN 60730-1:2016-10.

Paweł Jura

Janusz Master

Prezisi firmy

Wieprz, 14.07.2022

**TECH
TECH
CONTROLLERS**

Central headquarters:

ul. Biała Droga 31, 34-122 Wieprz

Service:

ul. Skotnica 120, 32-652 Bulowice

phone: **+48 33 875 93 80**

e-mail: **serwis@techsterowniki.pl**

www.tech-controllers.com