

TECH TECH CONTROLLERS

USER MANUAL EU-L-4 WiFi

EN



TABLE OF CONTENTS

I.	Safety	4
II.	Description of the device	5
III.	How to install the controller	6
IV.	Main screen description	8
1.	WiFi screen	8
2.	Screen - zone	9
3.	Screen – additional contacts	9
V.	Controller menu	10
1.	Block diagram – main menu	10
2.	Zones	11
2.1.	ON	11
2.2.	Type of sensor	11
2.3.	Floor heating	11
2.4.	Zone valve	11
2.5.	Pre-set temperature	12
2.6.	Operation mode	12
2.7.	Hysteresis	12
2.8.	Calibration	12
2.9.	Actuators	12
2.10.	Window sensors	13
3.	Operation modes	14
4.	External sensor	14
5.	Floor Pump	14
6.	Voltage-free contact	15
7.	Additional contacts	15
8.	Fitter's Menu	15
8.1.	Internet module	15
8.2.	Time settings	16
8.3.	Screen settings	16
8.4.	Service menu	16
8.5.	Factory settings	17
9.	Software version	17
VI.	System control via the Internet	17
1.	Home tab	18
1.	Zones tab	23
2.	Fitter's menu tab	23

3.	Statistics tab	24
4.	Settings tab.....	24
VII.	Software update	25
VIII.	Protections and alarms.....	25
IX.	Technical data	27

KN.11.08.2022

*The pictures and diagrams are for illustration purposes only.
The manufacturer reserves the right to introduce some changes.*

I. SAFETY

Before using the device for the first time the user should read the following regulations carefully. Not obeying the rules included in this manual may lead to personal injuries or controller damage. The user's manual should be stored in a safe place for further reference. In order to avoid accidents and errors it should be ensured that every person using the device has familiarized themselves with the principle of operation as well as security functions of the controller. If the device is to be sold or put in a different place, make sure that the user's manual is there with the device so that any potential user has access to essential information about the device.

The manufacturer does not accept responsibility for any injuries or damage resulting from negligence; therefore, users are obliged to take the necessary safety measures listed in this manual to protect their lives and property.



WARNING

- High voltage! Make sure the regulator is disconnected from the mains before performing any activities involving the power supply (plugging cables, installing the device etc.).
- The device should be installed by a qualified electrician.
- Before starting the controller, the user should measure earthing resistance of the electric motors as well as the insulation resistance of the cables.
- The regulator should not be operated by children.



NOTE

- The device may be damaged if struck by a lightning. Make sure the plug is disconnected from the power supply during storm.
- Any use other than specified by the manufacturer is forbidden.
- Before and during the heating season, the controller should be checked for condition of its cables. The user should also check if the controller is properly mounted and clean it if dusty or dirty.

Changes in the merchandise described in the manual may have been introduced subsequent to its completion on 11.08.2022. The manufacturer retains the right to introduce changes to the structure. The illustrations may include additional equipment. Print technology may result in differences in colours shown.

We are committed to protecting the environment. Manufacturing electronic devices imposes an obligation of providing for environmentally safe disposal of used electronic components and devices. Hence, we have been entered into a register kept by the Inspection For Environmental Protection. The crossed-out bin symbol on a product means that the product may not be disposed of to household waste containers. Recycling of wastes helps to protect the environment. The user is obliged to transfer their used equipment to a collection point where all electric and electronic components will be recycled.



II. DESCRIPTION OF THE DEVICE

The L-4 WiFi controller is intended for controlling the heating device. It controls the heating device and the valve actuators which regulate the water flowing to the maximum of 8 CH zones. The device has a built-in WiFi module enabling the user to view and edit the controller parameters using a mobile app eModul.

Controller functionalities:

- controlling eight different zones using:
 - wired sensor C-7p
 - wired regulator R-8z
 - floor sensor C-8f
 - wireless sensor C-8r, C-mini, R-8b, C-8r, CL-mini, R-8b or R-8bw
 - wireless thermostatic actuators STT-868 and STT-869 (max. 6 per zone)
 - wireless window sensors C-2n (max. 6 per zone)
- 1 relay output – voltage-free contact for controlling the pump or the heating device
- 4 relay outputs for controlling wired floor actuators in the first 4 zones. For all 8 zones it is possible to control wired floor valves using a wireless module MW-1.
- possibility of connecting wired (zone 1-4) and wireless (zone 1-8) floor sensors C-8f.
- software update via USB port.
- possibility of controlling up to 8 additional contacts MW-1 or ST-981. The contact operation is based on weekly control or control of the zones in which they are registered.
- cover made of high quality materials resistant to high and low temperature.



NOTE

In zones 1-4 the user may choose the type of temperature sensor - wired or wireless (one per zone). In zones 5-8 only wireless sensors may be used.

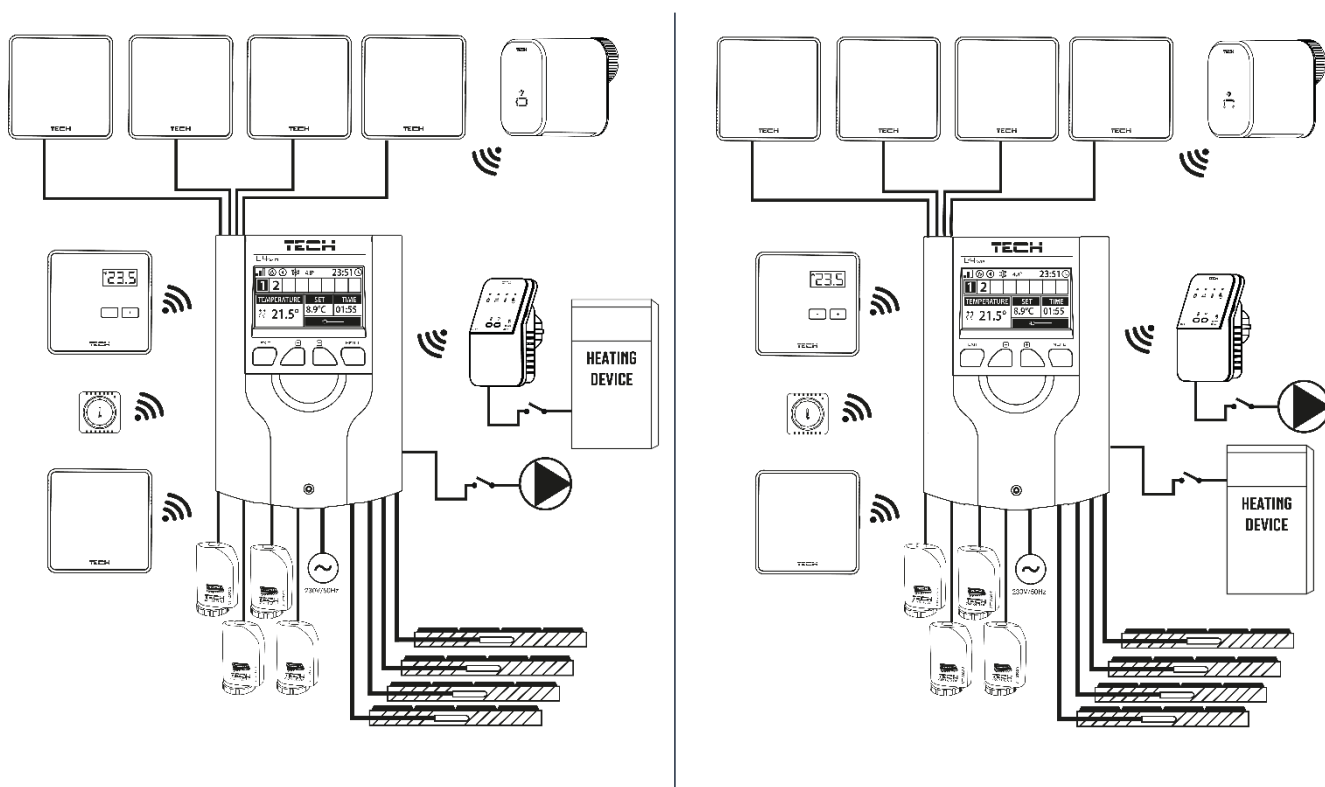

III. HOW TO INSTALL THE CONTROLLER

The controller should be installed by a qualified person.

WARNING

If pump manufacturer requires an external main switch, power supply fuse or additional residual current device selective for distorted currents it is recommended not to connect pumps directly to pump control outputs.

To avoid damaging to the device, an additional safety circuit must be used between the regulator and the pump. The manufacturer recommends the ZP-01 pump adapter, which must be purchased separately.

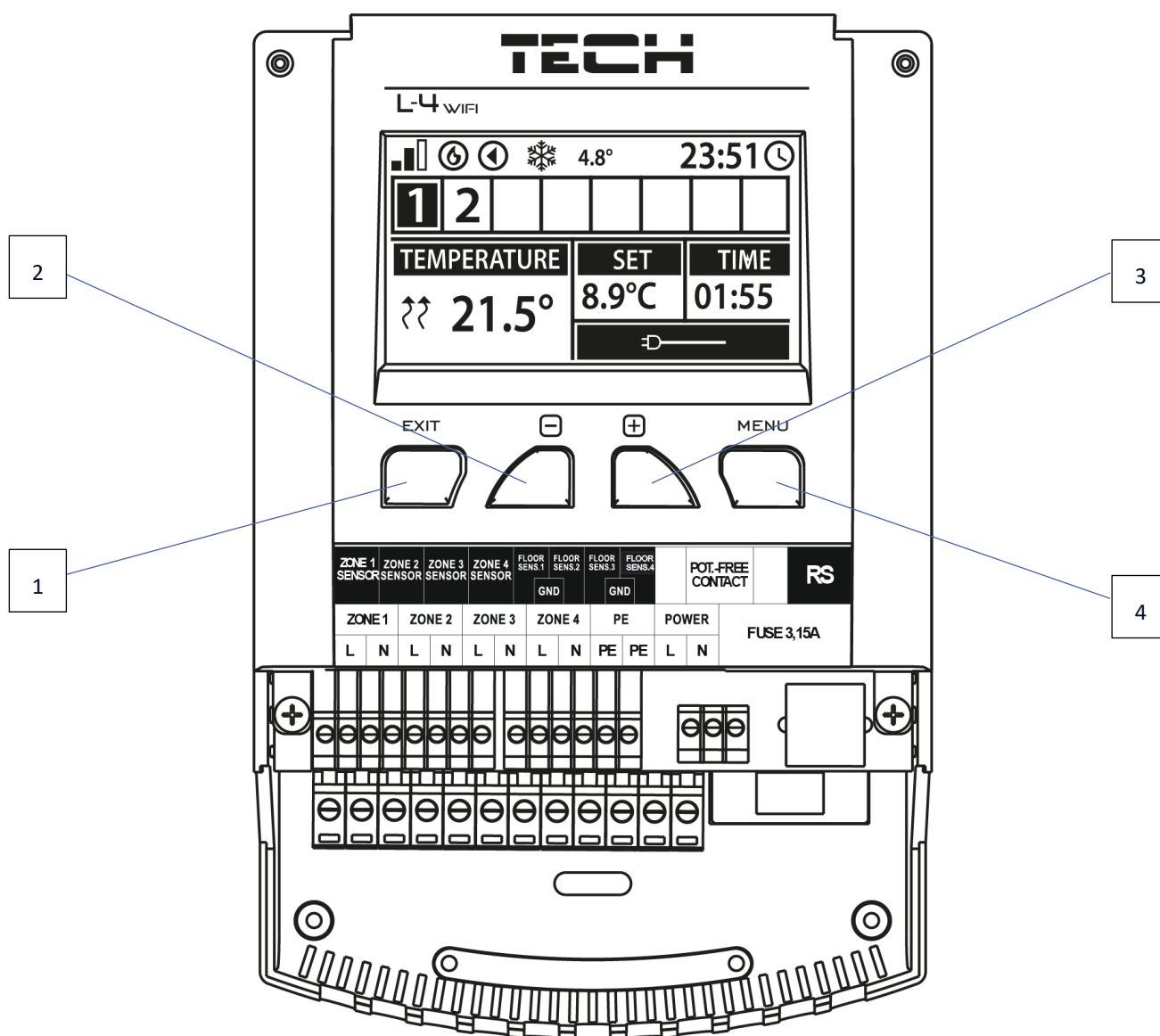

1. **EXIT button** – exit the menu, cancel the settings, choose the screen view (WiFi, Zones, Additional contacts).
2. **– (minus) button** – view menu functions, decrease the value while editing parameters.
3. **+ (plus) button** – view menu functions, increase the value while editing parameters.
4. **MENU button** – enter the controller menu, confirm the settings.

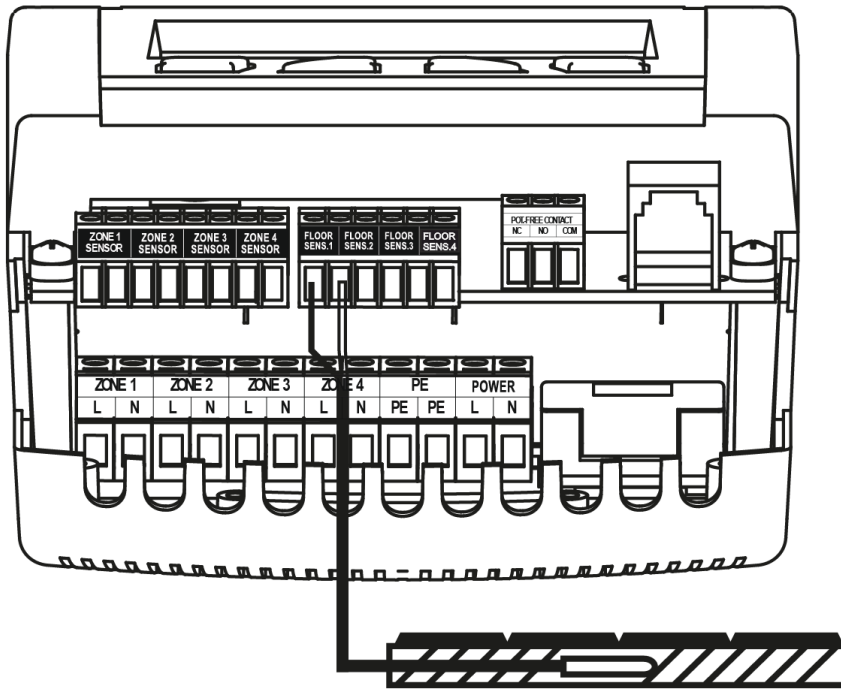

WARNING

Risk of fatal electric shock from touching live connections. Before working on the controller switch off the power supply and prevent it from being accidentally switched on.



NOTE





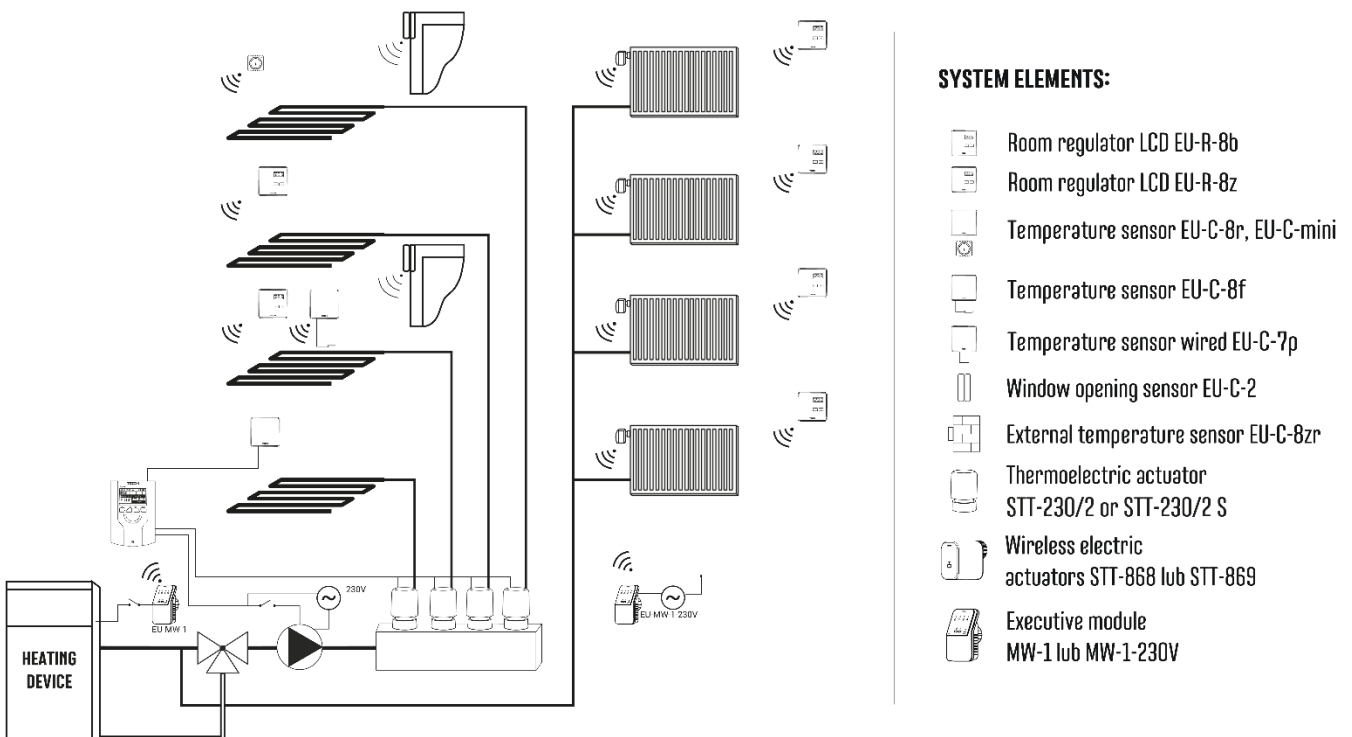

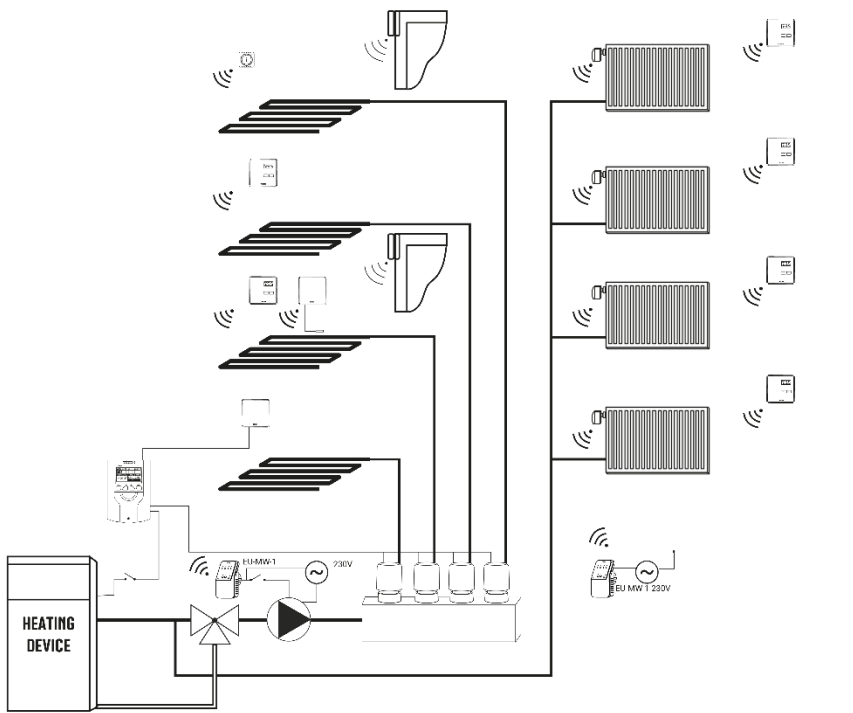



Sensor cables and supply cables should be connected to proper inputs.

The diagrams below show example systems:





SYSTEM ELEMENTS:

-  Room regulator LCD EU-R-8b
-  Room regulator LCD EU-R-8z
-  Temperature sensor EU-C-8r, EU-C-mini
-  Temperature sensor EU-C-8f
-  Temperature sensor wired EU-C-7p
-  Window opening sensor EU-C-2
-  External temperature sensor EU-C-8zr
-  Thermoelectric actuator STT-230/2 or STT-230/2 S
-  Wireless electric actuators STT-868 lub STT-869
-  Executive module MW-1 lub MW-1-230V

IV. MAIN SCREEN DESCRIPTION

At the first start-up the controller shows WiFi network screen. The screen view may be changed by pressing EXIT button and selecting a different screen.

1. WIFI SCREEN

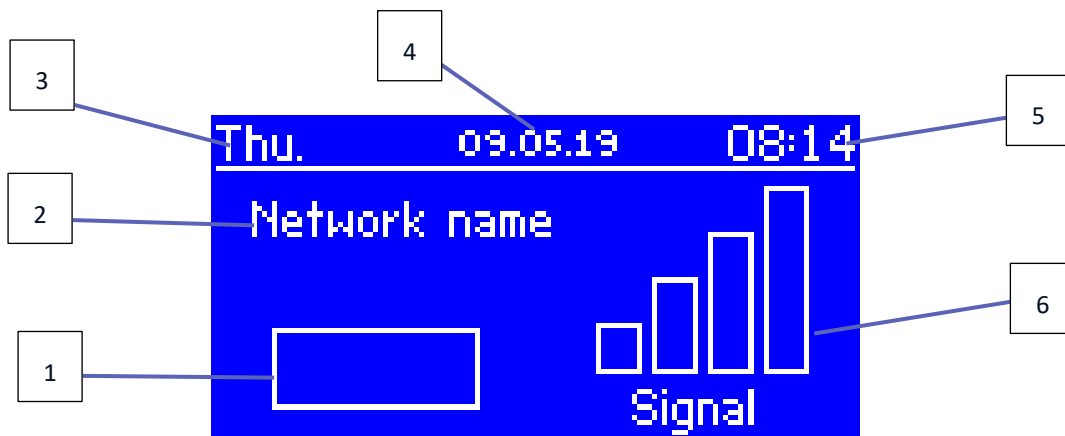

1. Network status
2. Network name
3. Day of the week
4. Date
5. Time
6. WiFi signal strength

2. SCREEN - ZONE

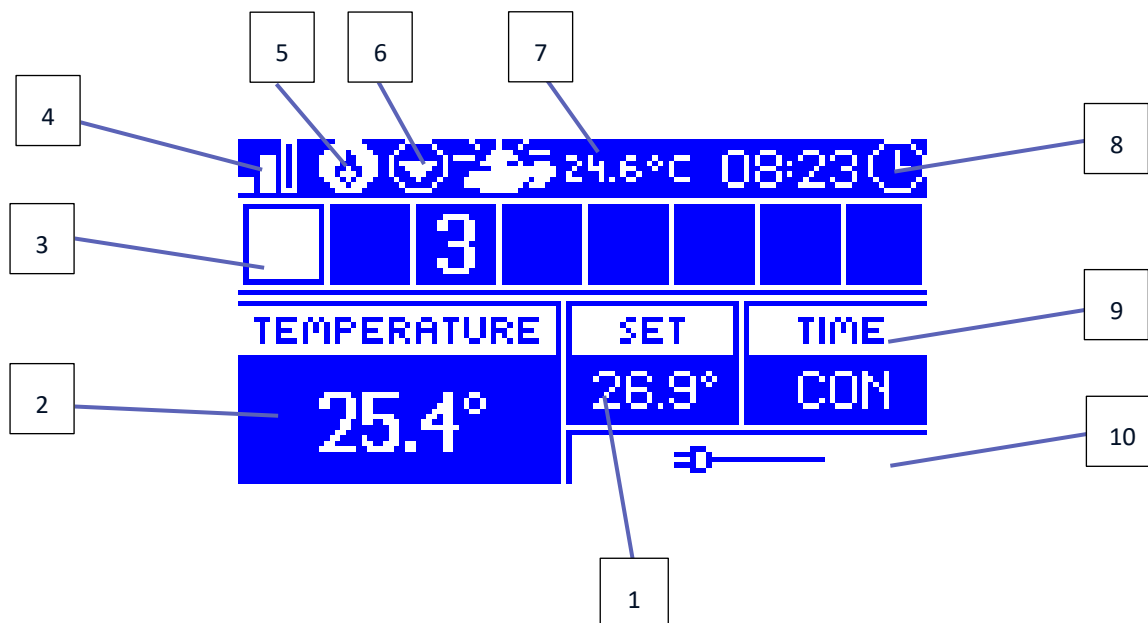

1. Pre-set zone temperature
2. Current zone temperature (two arrows pointing up indicate heating).
3. Zone number
4. WiFi signal strength
5. Active voltage-free contact (MW-1)
6. Active pump
7. Current external temperature. When the temperature outside drops below 5°C, a snowflake icon is displayed on the left. When the temperature outside is above 5°C, a sun icon is displayed on the left.
8. Current time
9. Type of weekly schedule active in the highlighted zone
10. Information about connected wired sensor. If a wireless sensor is registered, the display shows battery level and signal strength.

3. SCREEN – ADDITIONAL CONTACTS

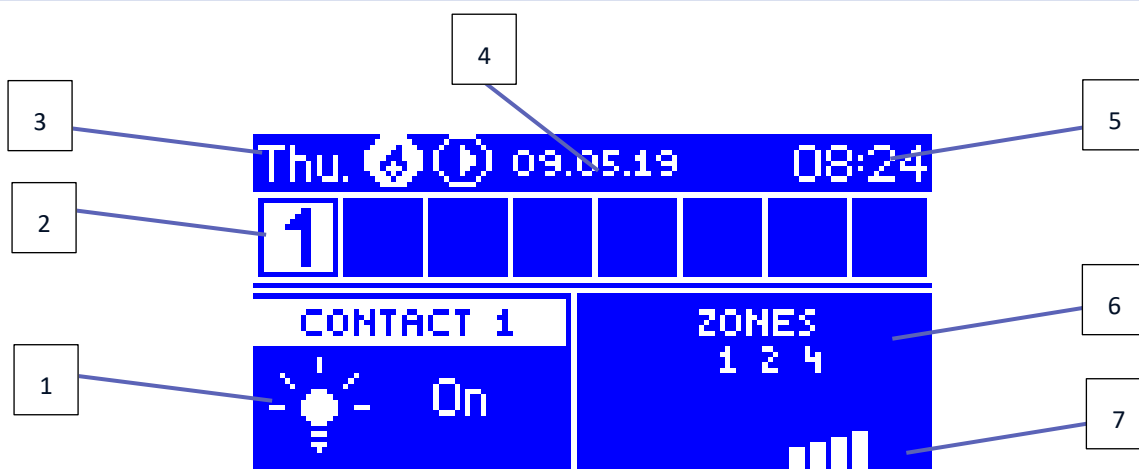

1. Current contact status (a lit bulb - the contact is active)
2. Zone numbers (active zone is highlighted in white)

3. Day of the week
4. Date
5. Time
6. Zones in which the contact is registered
7. Contact signal strength

V. CONTROLLER MENU

1. BLOCK DIAGRAM – MAIN MENU

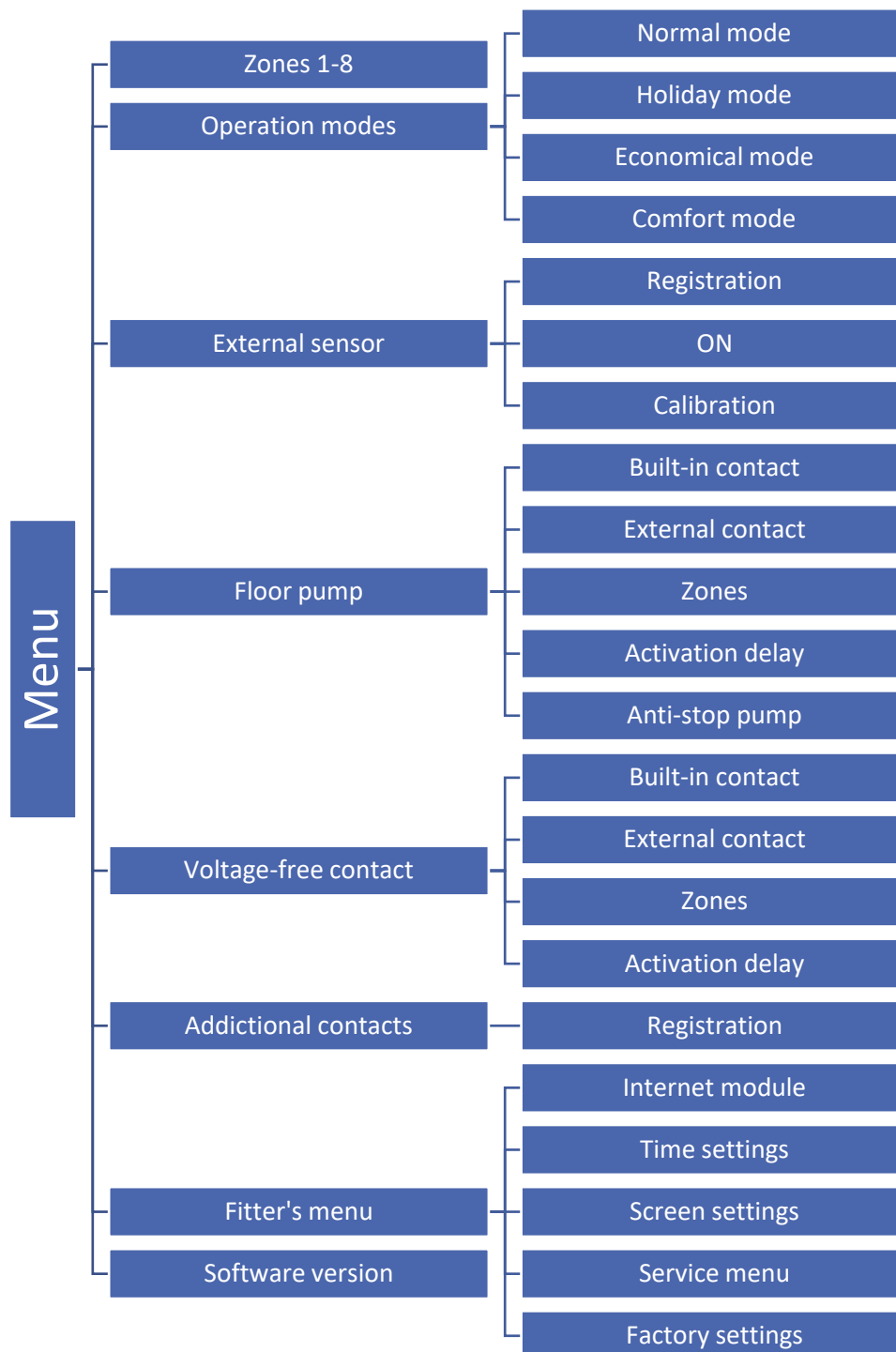

2. ZONES

This submenu enables the user to configure operation parameters for particular zones.

REGISTRATION

This function enables the user to register the C-8r, C-mini or CL-mini sensor or the R-8b, R-8bw regulators.

It is also possible to register the C-8f floor sensor as a zone sensor. As a consequence, the zone control will be based on floor temperature.

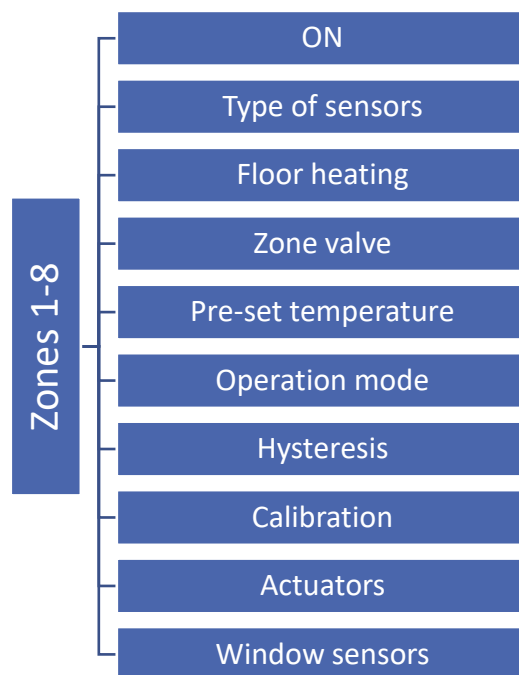

2.1. ON

Once the sensor has been registered in a given zone, it will be used by the L-4 controller. The user may activate the sensor by selecting <ON>.

2.2. TYPE OF SENSOR

This option enables the user to choose between wired and wireless sensor (it concerns zones 1-4).

2.3. FLOOR HEATING

- **Registration** – to register the floor sensor C-8f in a given zone, first register the zone sensor, then select <Registration> in the the L-4 controller and press the communication button on the selected C-8f sensor. After successful registration, an appropriate message will appear on the display of the L-4 controller and the control light on the C-8f sensor will blink twice.
- **Type of sensor** – this option enables the user to choose between wired sensor (zone 1-4) and wireless sensor (zone 1-8).

2.4. ZONE VALVE

This function enables the user to choose the type of valve between wired ST-230/2 (zone 1-4) and wireless STT-230V/2 controlled via a wireless module MW-1-230V (zone 1-8). If <Wireless> is selected, it is necessary to register the module.

2.5. PRE-SET TEMPERATURE

The pre-set zone temperature depends on the weekly schedule settings. The user may also change this value separately. After the value has been set, the user defines how long the temperature should apply. When the time elapses, the pre-set temperature depends on the weekly schedule again.

2.6. OPERATION MODE

- **Local schedule** – it is a weekly schedule assigned to one zone only. Once a room sensor is detected by the controller, it is automatically assigned to this zone. It may be edited freely.
- **Global schedule 1-5** – Global schedule may be assigned to any number of zones. Changes introduced in the global schedule apply in all the zones where this schedule has been selected.
- **Constant temperature** – The user sets the temperature which will be maintained until this option is deactivated. After deactivation, the pre-set temperature will depend on the current schedule.
- **With time limit** – This function enables the user to define the pre-set temperature which will apply for a pre-defined period of time. When the time is over, the pre-set temperature will depend on the previous mode (schedule or constant temperature without time limit).

2.7. HYSTERESIS

Hysteresis defines tolerance of the pre-set temperature in order to prevent undesired oscillation in case of small temperature fluctuation within the range 0,1 - 10°C with the accuracy of 0,1°C.

Example: if the pre-set temperature is 23°C and the hysteresis is 1°C, the zone temperature is considered too low when it drops to 22°C.

2.8. CALIBRATION

Room sensor calibration should be performed while mounting or after it has been used for a long time, if the zone temperature displayed differs from the actual temperature. Calibration setting range is from -10°C to +10°C with the accuracy of 0,1°C.

2.9. ACTUATORS

- **Registration** – This option concerns wireless actuators STT-868 and STT-869. The registration process is described in the instruction manual of particular actuators.

The number displayed next to Registration icon informs about the number of registered valves (max. 6).

- **Valve removal** – this option is used to delete all wireless thermostatic actuators STT-868 or STT-869 registered in the zone from the controller memory.
- **Settings**

SIGMA – this function enables smooth control of the thermostatic actuator. The user may define the maximum and minimum valve opening – the level of valve opening and closing will never exceed these values.

Moreover, the user configures <Range> parameter, which defines the room temperature at which the valve starts closing and opening.

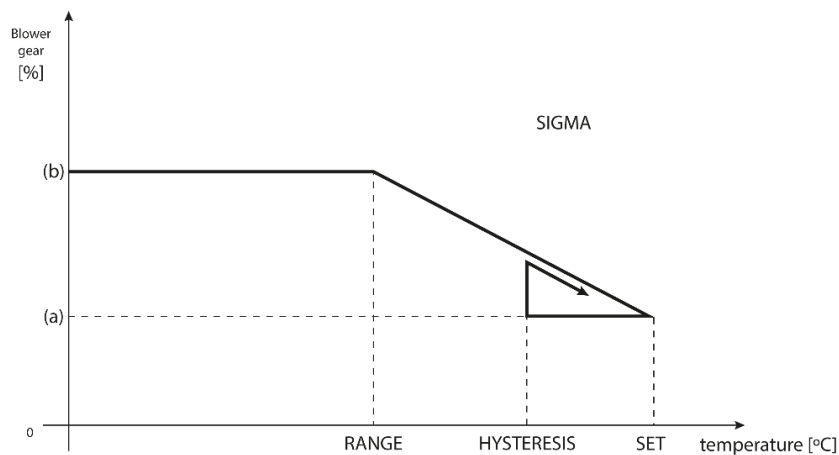

(a) - min. opening
 (b) - Actuator opening
 ZAD - set temperature

Example:

Pre-set zone temperature: 23°C
 Minimum opening: 30%
 Maximum opening: 90%
 Range: 5°C
 Hysteresis: 2°C

In the above example, the thermostatic valve starts closing at the temperature of 18°C (pre-set value minus Range). The minimum opening is reached when the zone temperature reaches the pre-set value.

Once the pre-set temperature has been reached, the temperature starts falling. At the temperature of 21°C (pre-set value minus hysteresis), the valve starts opening. The maximum opening is reached at the temperature of 18°C.

EMERGENCY MODE – this function opens the actuators if an alarm occurs in a zone (sensor failure, communication error).

PROTECTION – Once this function has been selected, the controller checks the temperature. If the pre-set value has been exceeded by the number of degrees specified in the <range> parameter, all actuators in the zone will close (0% of opening). This protection is enabled by default.

2.10. WINDOW SENSORS

- **Registration** – in order to register a window sensors, select <Registration> and press quickly the communication button on the window sensor. Release the button and watch the control light.
 - control light flashes twice - proper communication established.
 - control light lights up continuously - no communication with the main controller.



NOTE

The controller supports the maximum of 6 window sensors in a zone.

- **Sensor removal** – this function is used to remove all the registered sensors in a given zone from the controller memory.

- **Settings** – This function is used to activate the window sensor (possible after sensor registration) and set the delay time.

When the pre-set delay time is over, the main controller sends the information to the actuators forcing them to close. The time setting range is 0-30 minutes. Example:

Delay time is set at 10 minutes. When the window is opened, the sensor sends the information to the main controller. If the sensor sends another information that the window is open after 10 minutes, the main controller will force the actuators to close and the heating in the zone will be disabled.



NOTE

If the delay time is set at 0 minutes, the message forcing the actuators to close will be sent immediately.

3. OPERATION MODES

This function enables the user to activate one of the following operation modes in a given zone.

- Normal mode – the temperature depends on the selected schedule.
- Holiday mode – the pre-set temperature depends on the "Temperature settings" parameter (Menu>Zones>Temperature settings>Holiday)
- Economical mode – the pre-set temperature depends on the "Temperature settings" parameter (Menu>Zones>Temperature settings>Economical temp.)
- Comfort mode – the pre-set temperature depends on the "Temperature settings" parameter (Menu>Zones>Temperature settings>Comfort temp.)



NOTE

Changing the mode to holiday, economical and comfort applies to all zones. It is possible to edit the pre-set temperature of the selected mode for a particular zone. In the operation mode other than normal, it is not possible to change the pre-set temperature from the level of a regulator.

4. EXTERNAL SENSOR

It is possible to connect an external sensor to the controller to be able to view current outside temperature on the zone screen. The external sensor is not involved in temperature control. In order to register the sensor, follow these steps:

- Select registration option in L-4 WiFi
- Press the registration button on the sensor

Once the module has been registered, the controller will offer new options - reading the radio signal, checking the battery level and performing sensor calibration.

Calibration should be performed while mounting or after it has been used for a long time, if the external temperature displayed differs from the actual temperature. Calibration setting range is from -10°C to +10°C with the accuracy of 0,1°C.

5. FLOOR PUMP

L-4 WiFi controls the pumps - it enables the pump after the delay time if the temperature of any zone is too low. When all the zones reach their pre-set temperatures, the controller disables the pump.

The user may:

- choose the device connected to the built-in voltage-free contact (default setting - floor pump) by selecting 'Built-in contact'.
- register a wireless additional pump contact (executive module)
- switch off a given zone
- set up activation delay (if the temperature in a given zone is too low, the contact will be enabled after the delay time).

6. VOLTAGE-FREE CONTACT

This function enables the user to register wireless module MW-1. Once the module has been registered, the user may enable the contact, remove it and view the radio signal strength.

The voltage-free contact is activated if the temperature in any zone is too low.



NOTE

Selecting 'Built-in contact' option in Voltage-free contact function results in switching from operating the built-in voltage-free contact (by default configured to control the floor pump) to operating the heating device!

7. ADDITIONAL CONTACTS

Follow these steps to register the MW-1 module:

- Select registration option in the L-4 WiFi controller
- Press the registration button in the MW-1 module



NOTE

It is possible to register the maximum of 8 MW-1 modules.

Once the module has been registered, it is possible to choose the operation mode of the contact: weekly control or the control of the zones to which the additional contact is assigned. The additional contact options enable the user to view the radio signal strength and remove a module from the controller memory.

If you select Zones as the operation mode, it is necessary to select the zones to which the additional contact should be assigned.

8. FITTER'S MENU

8.1. INTERNET MODULE

Required network settings

For the Internet module to work properly, it is necessary to connect the module to the network with a DHCP server and an open port 2000.

After connecting the Internet module to the network, go to the module settings menu (in the master controller).

If the network does not have a DHCP server, the Internet module should be configured by its administrator by entering appropriate parameters (DHCP, IP address, Gateway address, Subnet mask, DNS address).

1. Go to the Internet module settings menu.
2. Select "ON".
3. Check if the "DHCP" option is selected.
4. Go to "WIFI network selection"
5. Select your WIFI network and enter the password.
6. Wait for a while (approx. 1 min) and check if an IP address has been assigned. Go to the "IP address" tab and check if the value is different from 0.0.0.0 / -.-.-.-.
 - a) If the value is still 0.0.0.0 / -.-.-.-, check the network settings or the Ethernet connection between the Internet module and the device.
7. After the IP address has been assigned, start the module registration in order to generate a code which must be assigned to the account in the application.

- WiFi network selection

After entering this submenu, the controller displays a list of available networks. After selecting the network which we want to connect with, confirm by pressing the MENU button. If the network is secured, a password is required. Use the + and - buttons to select subsequent letters of the password. Press EXIT to complete.

- Network configuration

The standard network configuration is performed automatically. However, it is possible to do it manually using the options of this submenu: DHCP, IP address, Subnet mask, Gateway address, DNS address and MAC address.

- Registration

Select this option to generate a code necessary to register the controller at emodul.eu.

8.2. TIME SETTINGS

The current time and date are automatically downloaded from the network. The user can switch the synchronization to manual mode.

8.3. SCREEN SETTINGS

These parameters enable the user to customize the screen settings to satisfy individual needs. The user may choose the data to be displayed in the main screen view:

- WiFi – the screen shows the network name and the signal strength.
- Zones – the screen shows current and pre-set parameters in particular zones.
- Additional contacts – the screen shows the status of additional contacts controlled using weekly control mode.

Apart from that, the user may adjust:

- the display contrast
- the screen brightness
- the blank screen brightness
- the time of inactivity after which the screen blanking is activated.

8.4. SERVICE MENU

In order to access service functions it is necessary to enter a four-digit code provided by TECH.

8.5. FACTORY SETTINGS

Once the <Factory settings> option is activated, all customized settings are lost and replaced with the manufacturer's settings.

9. SOFTWARE VERSION

When this option is selected, the display shows the manufacturer's logo and the controller software version.

VI. SYSTEM CONTROL VIA THE INTERNET

The emodul.eu website offers a wide range of possibilities to control the heating system. In order to take full advantage of it, it is necessary to create an account:

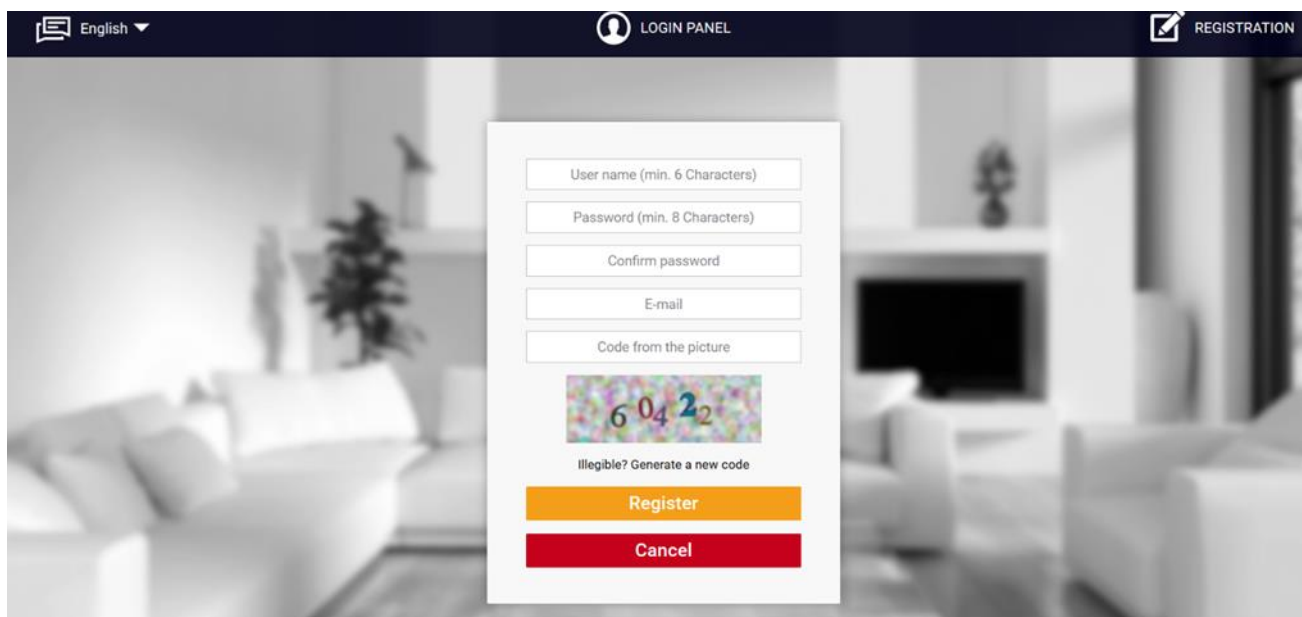

The screenshot shows a web browser interface for the emodul.eu website. At the top, there is a dark navigation bar with a language dropdown set to 'English', a 'LOGIN PANEL' button with a user icon, and a 'REGISTRATION' button with a checkmark icon. The main content area features a registration form overlaid on a blurred background of a modern living room. The form includes the following fields: 'User name (min. 6 Characters)', 'Password (min. 8 Characters)', 'Confirm password', 'E-mail', and 'Code from the picture'. Below the code field is a CAPTCHA image showing the numbers '6 0 4 2 2' on a colorful background. Underneath the CAPTCHA is the text 'Illegible? Generate a new code'. At the bottom of the form are two buttons: an orange 'Register' button and a red 'Cancel' button.

Once logged in, go to *Settings* tab and select *Register module*. Next, enter the code generated by the controller (to generate the code, select Registration in the controller menu). The module may be assigned a name (in the are labelled *Module description*):

1. HOME TAB

The Home tab displays the main screen with tiles illustrating the current status of particular heating system devices. Tap on the tile to adjust the operation parameters:



NOTE

„No communication” message means that the communication with the temperature sensor in a given zone has been interrupted. The most common cause is a flat battery which needs replacing.

Tap on the tile corresponding to a given zone to edit its pre-set temperature:

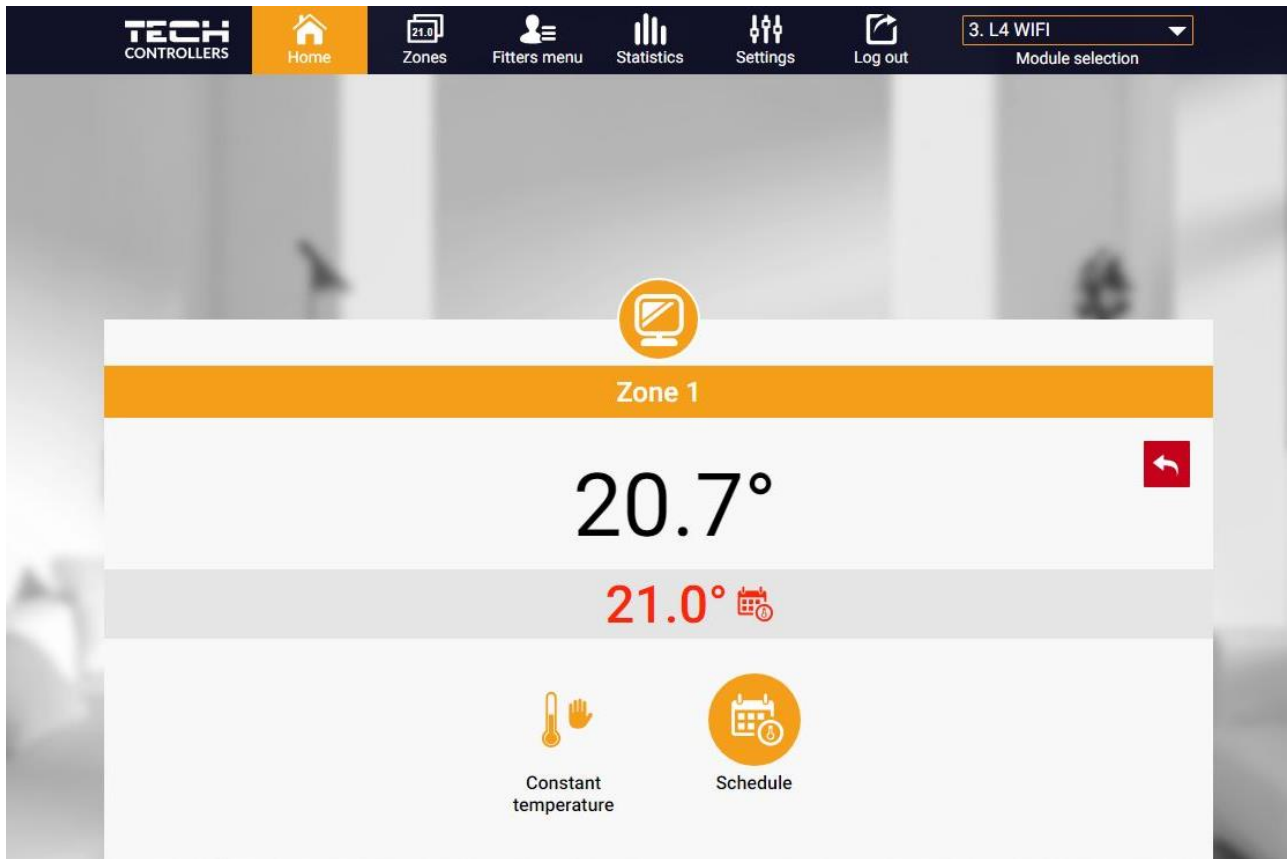

The upper value is the current zone temperature whereas the bottom value is the pre-set temperature.

The pre-set zone temperature depends by default on the weekly schedule settings. *Constant temperature* mode enables the user to set a separate pre-set temperature value which will apply in the zone regardless of the time.

Selecting *Constant temperature* icon, the user may choose the temperature with time limit. The mode enables the user to set the temperature value which will apply only within the pre-defined period of time. When the period is over, again the pre-set temperature depends on the previous mode (a schedule or constant temperature without time limit).



Zone 1

With time limitation

Hours

1

Minutes

0

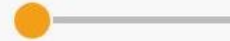
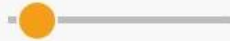

Tap on *Schedule* icon to open up the weekly schedule selection screen:

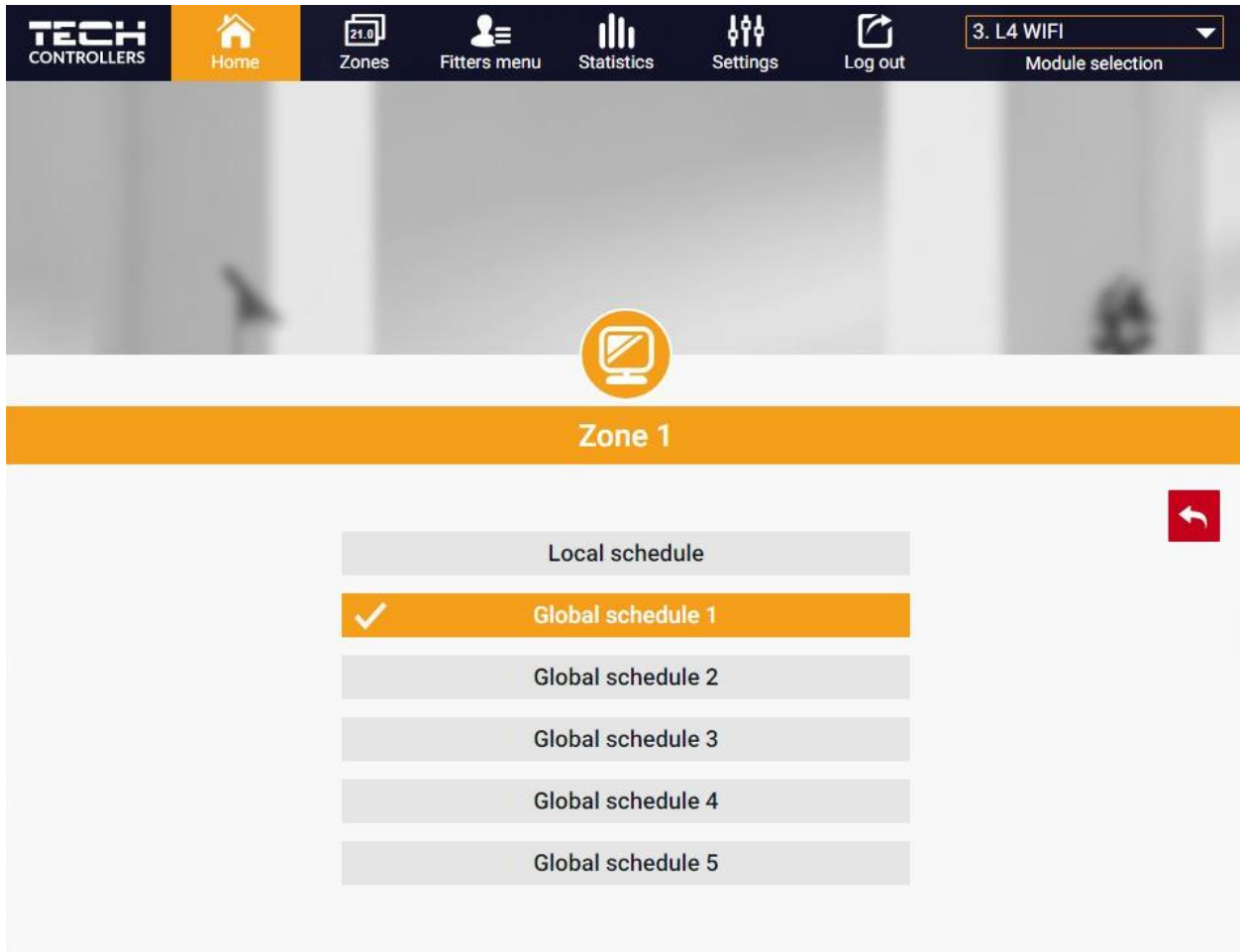

Two types of weekly schedules are available in the controller:

1. Local schedule

It is a weekly schedule assigned to a particular zone. Once the controller detects the room sensor, the schedule is assigned automatically to the zone. It may be edited by the user.

2. Global schedule (Schedule 1-5)

A global schedule may be assigned to any number of zones. The changes introduced in the global schedule apply to all zones where the global schedule has been activated.

After selecting the schedule press OK and move on to edit the weekly schedule settings:

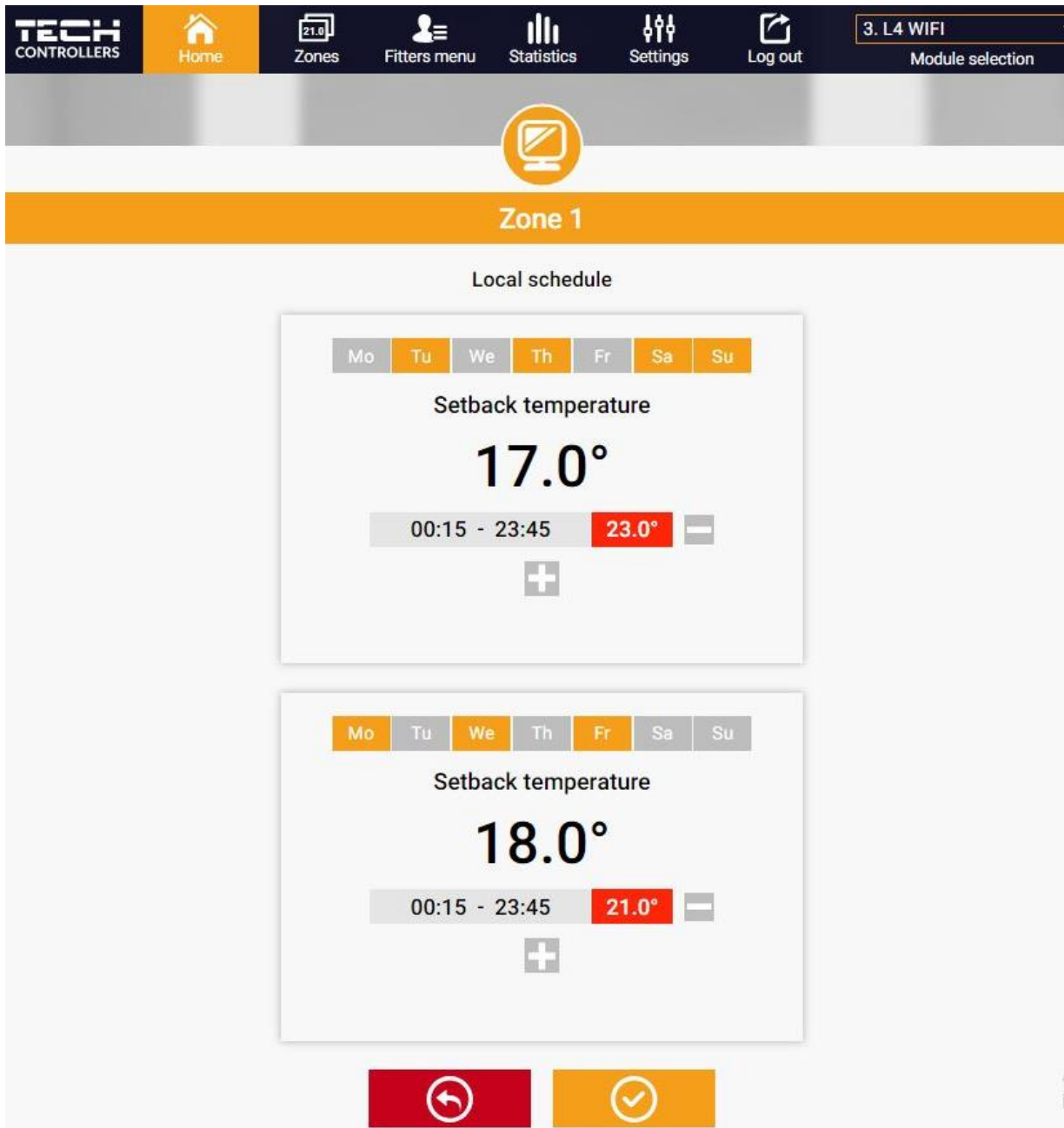

Editing each schedule enables the user to define two programs and select days when the programs will be active (e.g. from Monday to Friday and the weekend). The starting point for each program is the pre-set temperature value.

For each program the user may define up to 3 time periods when the temperature will be different from the pre-set value. The time periods must not overlap. Outside the time periods the pre-set temperature will apply. The accuracy of defining the time periods is 15 minutes.

1. ZONES TAB

The user may customize the home page view by changing zone names and corresponding icons. In order to do it, go to Zones tab:

The screenshot displays the 'Zones' tab in the TECH CONTROLLERS application. The top navigation bar features icons for Home, Zones, Fitters menu, Statistics, Settings, and Log out, along with a 'Module selection' dropdown set to '3. L4 WIFI'. Below the navigation bar is a large orange header with the word 'Zones' and a circular icon containing '21.0'. The main content area is divided into two sections for 'Zone 1' and 'Zone 2'. Each section includes a 'Name' field (containing 'Zone 1' and 'Zone 2' respectively), an 'Icon' selection row with various icons, and 'Options' with 'Turn off' and 'Reset' buttons. The status bar at the bottom of each zone section shows '100%' battery and '100%' signal strength.

2. FITTER'S MENU TAB

The Fitter's menu tab enables the user to configure the parameters of:

- the room sensor
- the floor sensor
- the valve
- the actuators
- the window sensors
- the pump
- the additional contacts

3. STATISTICS TAB

Statistics tab enables the user to view the temperature values for different time periods e.g. 24h, a week or a month. It is also possible to view the statistics for the previous months:



4. SETTINGS TAB

Settings tab enables the user to register a new module and change the e-mail address or the account password:

TECH CONTROLLERS Home Zones Fitters menu Statistics Settings Log out 3. L4 WIFI Module selection

Settings

Account Module

Account settings

User

E-mail

Current password

New password

Confirm password

Last update 2019-02-22, 09:47

VII. SOFTWARE UPDATE

In order to conduct the software update, follow these steps:

1. Disconnect the controller from the power supply
2. Insert a flash drive with new software into the USB port.
3. Connect the controller to the power supply.
4. Once the software update has been completed, the controller restarts automatically.



NOTE

Software update restores factory settings. After the software has been updated, it is not possible to restore previous settings.

VIII. PROTECTIONS AND ALARMS

In the event of an alarm, a sound signal is activated and the display shows an appropriate message.

Alarm	Possible cause	How to fix it
Sensor damaged (in the case of wired sensor failure).	Wired sensor damaged	- Check the connection between the sensor and the controller and the condition of cables.
No communication with sensor/wireless regulator	- No range - No batteries - Flat batteries	- Put the sensor/regulator in a different place - Insert batteries in the sensor/regulator
STT-868 actuator alarm		
Actuator alarm - ERROR #0 - low battery level	Flat battery in the actuator	Replace the batteries
Actuator alarm - ERROR #1 – possible damage of mechanical or electronic parts	Some parts have been damaged	Call the service staff
Actuator alarm - ERROR#2 – the maximum actuator stroke has been exceeded	- No piston controlling the valve - Too big stroke (movement) of the valve - The actuator has been incorrectly mounted on the radiator - Inappropriate valve on the radiator	- Install a piston controlling the actuator - Check the valve stroke - Install the actuator correctly - Replace the valve on the radiator
Actuator alarm - ERROR#3 – too little piston movement	- The valve got stuck - Inappropriate valve on the radiator - Too little stroke (movement) of the valve	- Inspect the valve operation - Replace the valve on the radiator - Check the valve stroke
Actuator alarm - ERROR #4 – no return communication (to the actuator)	- Out of range - No batteries	- The actuator is too far from the controller - Insert batteries into the actuator After the communication is re-established, the alarm is deactivated automatically.

STT-869 actuator alarm		
Error #1 - Calibration error 1 – Moving the screw to the mounting position took too much time	- The limit switch sensor is damaged	- Calibrate actuator again by holding the communication button until the third flash of green light - Call the service staff
Error #2 - Calibration error 2 – The screw is maximally pulled out. No resistance while pulling out	- The actuator has not been screwed to the valve or has not been screwed completely - The valve stroke is too big or the valve dimensions are not typical - Actuator current sensor is damaged	- Check if the controller has been installed properly - Replace the batteries - Calibrate actuator again by holding the communication button until the third flash of green light - Call the service staff
Error #3 - Calibration error 3 - The screw has not been pulled out enough - the screw meets resistance too early	- The valve stroke is too small or the valve dimensions are not typical - Actuator current sensor is damaged - Low battery level	- Replace the batteries - Call the service staff
Error #4 - No feedback	- The master controller is switched off - Poor range or no range in the master controller - Radio module in the actuator is damaged	- Check if the master controller is on - Reduce the distance from the master controller - Call the service staff
Error #5 - Low battery level	The battery is flat	Replace the batteries
Error #6 - Encoder is locked	The encoder is damaged	- Calibrate actuator again by holding the communication button until the third flash of green light
Error #7 - Too high voltage	- Unevenness of the screw, the thread etc. may cause excessive resistance - Too high resistance of gear or motor - Current sensor is damaged	- Call the service staff
Error #8 - Limit switch sensor error	Limit switch sensor damaged	

IX. TECHNICAL DATA

Power supply	230V +/- 10% / 50Hz
Max. power consumption	3W
Ambient working temperature	5°C ÷ 50°C
NTC sensor thermal resistance	-30°C ÷ 50°C
Potential contacts 1-4 max. output load	0,5A
Potential-free cont. nom. out. load	230V AC / 0,5A (AC1) * 24V DC / 0,5A (DC1) **
Operation frequency	868MHz
Fuse	3,15A
Transmission	IEEE 802.11 b/g/n

* AC1 load category: single-phase, resistive or slightly inductive AC load.

** DC1 load category: direct current, resistive or slightly inductive load.



EU Declaration of conformity

Hereby, we declare under our sole responsibility that **EU-L-4 WiFi** manufactured by TECH STEROWNIKI II Sp. z o.o., head-quartered in Wieprz Biała Droga 31, 34-122 Wieprz, is compliant with Directive **2014/53/EU** of the European parliament and of the Council of 16 April 2014 on the harmonisation of the laws of the Member States relating to the making available on the market of radio equipment, Directive **2009/125/EC** establishing a framework for the setting of ecodesign requirements for energy-related products as well as the regulation by the MINISTRY OF ENTREPRENEURSHIP AND TECHNOLOGY of 24 June 2019 amending the regulation concerning the essential requirements as regards the restriction of the use of certain hazardous substances in electrical and electronic equipment, implementing provisions of Directive (EU) 2017/2102 of the European Parliament and of the Council of 15 November 2017 amending Directive 2011/65/EU on the restriction of the use of certain hazardous substances in electrical and electronic equipment (OJ L 305, 21.11.2017, p. 8).

For compliance assessment, harmonized standards were used:

PN-EN IEC 60730-2-9 :2019-06 art. 3.1a Safety of use

PN-EN IEC 62368-1:2020-11 art. 3.1 a Safety of use

PN-EN 62479:2011 art. 3.1 a Safety of use

ETSI EN 301 489-1 V2.2.3 (2019-11) art.3.1b Electromagnetic compatibility

ETSI EN 301 489-3 V2.1.1 (2019-03) art.3.1 b Electromagnetic compatibility

ETSI EN 301 489-17 V3.2.4 (2020-09) art.3.1b Electromagnetic compatibility

ETSI EN 300 328 V2.2.2 (2019-07) art.3.2 Effective and coherent use of radio spectrum

ETSI EN 300 220-2 V3.2.1 (2018-06) art.3.2 Effective and coherent use of radio spectrum

ETSI EN 300 220-1 V3.1.1 (2017-02) art.3.2 Effective and coherent use of radio spectrum

PN EN IEC 63000:2019-01 RoHS

Wieprz, 11.08.2022

Paweł Jura

Janusz Master

Prezesa firmy

**TECH
TECH
CONTROLLERS**

Central headquarters:

ul. Biała Droga 31, 34-122 Wieprz

Service:

ul. Skotnica 120, 32-652 Bulowice

phone: **+48 33 875 93 80**

e-mail: **serwis@techsterowniki.pl**

www.tech-controllers.com