

# TECH TECH CONTROLLERS

## USER MANUAL EU-L-9r

EN



## TABLE OF CONTENTS

<b>I.</b>	<b>Safety</b> .....	5
<b>II.</b>	<b>Device Description</b> .....	6
<b>III.</b>	<b>How to install the controller</b> .....	6
<b>IV.</b>	<b>First start-up</b> .....	6
<b>V.</b>	<b>Main screen view and description</b> .....	14
<b>VI.</b>	<b>Controller functions</b> .....	16
1.	Block diagram – controller menu .....	16
2.	Operation mode .....	17
3.	Zones .....	17
4.	External sensor .....	17
4.1.	Weather-based control.....	17
4.2.	Calibration .....	17
5.	Manual mode .....	17
6.	Registration .....	18
7.	Time settings .....	18
8.	Display settings.....	18
9.	Language selection .....	18
10.	Fitter's menu.....	18
11.	SERVICE menu.....	18
12.	Software version .....	18
<b>VII.</b>	<b>Zones</b> .....	18
1.	Type of sensor .....	18
2.	Pre-set temperature.....	19
3.	Operation mode .....	19
4.	User settings.....	19
4.1.	House heating.....	19
4.2.	Heating.....	19
4.3.	Cooling .....	19
4.4.	Temperature settings .....	20
5.	Floor heating .....	20
5.1.	Registration.....	20
5.2.	Information.....	20
5.3.	Operation mode .....	20
5.4.	Minimum temperature .....	20
5.5.	Maximum temperature .....	21
5.6.	Hysteresis.....	21

5.7.	Calibration .....	21
6.	Hysteresis .....	21
7.	Calibration .....	21
8.	Thermostatic actuators .....	21
8.1.	Registration.....	21
8.2.	Valve actuators .....	22
8.3.	Information .....	22
8.4.	Settings .....	22
9.	Window sensors .....	23
9.1.	Registration.....	23
9.2.	Sensor removal .....	23
9.3.	Information .....	23
9.4.	Settings .....	23
<b>VIII.</b>	<b>Fitter's menu.....</b>	<b>24</b>
1.	Contact operation modeVoltage-free contact .....	24
1.1.	Pump.....	24
2.	Additional contacts.....	24
2.1.	Registration.....	24
3.	Heating - cooling.....	25
4.	Valve settings .....	25
4.1.	ON/OFF .....	25
4.2.	Pre-set valve temperature.....	25
4.3.	Calibration .....	25
4.4.	Single stroke .....	26
4.5.	Minimum opening .....	26
4.6.	Opening time .....	26
4.7.	Measurment pause.....	26
4.8.	Valve hysteresis .....	26
4.9.	Valve type .....	26
4.10.	Weather – based control .....	27
4.11.	Room regulator .....	27
4.12.	Proportionality coefficient.....	27
4.13.	Opening direction .....	27
4.14.	Return protection .....	27
4.15.	Valve pump .....	27
4.16.	Valve removal .....	28
4.17.	Factory settings.....	28

5.	Humidity protection .....	28
6.	Factory settings .....	28
<b>IX.</b>	<b>Schedule settings</b> .....	<b>29</b>
<b>X.</b>	<b>Software update</b> .....	<b>30</b>
<b>XI.</b>	<b>Technical data</b> .....	<b>30</b>
<b>XII.</b>	<b>Protections and alarms</b> .....	<b>31</b>

KN.24.05.2023

## I. SAFETY

Before using the device for the first time the user should read the following regulations carefully. Not obeying the rules included in this manual may lead to personal injuries or controller damage. The user's manual should be stored in a safe place for further reference. In order to avoid accidents and errors it should be ensured that every person using the device has familiarized themselves with the principle of operation as well as security functions of the controller. If the device is to be sold or put in a different place, make sure that the user's manual is there with the device so that any potential user has access to essential information about the device.

The manufacturer does not accept responsibility for any injuries or damage resulting from negligence; therefore, users are obliged to take the necessary safety measures listed in this manual to protect their lives and property.



### WARNING

- High voltage! Make sure the regulator is disconnected from the mains before performing any activities involving the power supply (plugging cables, installing the device etc.).
- The device should be installed by a qualified electrician.
- Before starting the controller, the user should measure earthing resistance of the electric motors as well as the insulation resistance of the cables.
- The regulator should not be operated by children.



### NOTE

- The device may be damaged if struck by a lightning. Make sure the plug is disconnected from the power supply during storm.
- Any use other than specified by the manufacturer is forbidden.
- Before and during the heating season, the controller should be checked for condition of its cables. The user should also check if the controller is properly mounted and clean it if dusty or dirty.

---

Changes in the merchandise described in the manual may have been introduced subsequent to its completion on 24.05.2023. The manufacturer retains the right to introduce changes to the structure. The illustrations may include additional equipment. Print technology may result in differences in colours shown.

---

We are committed to protecting the environment. Manufacturing electronic devices imposes an obligation of providing for environmentally safe disposal of used electronic components and devices. Hence, we have been entered into a register kept by the Inspection For Environmental Protection. The crossed-out bin symbol on a product means that the product may not be disposed of to household waste containers. Recycling of wastes helps to protect the environment. The user is obliged to transfer their used equipment to a collection point where all electric and electronic components will be recycled.



## II. DEVICE DESCRIPTION

EU-L-9r external controller is intended for controlling valves. The controller enables significant energy saving due to precise temperature management in particular rooms. Due to advanced software, the controller fulfils a wide range of functions:

- possibility of controlling thermoelectric actuators via 8 room sensors or room regulators EU-C-7p, EU-C-8r, EU-R-8b, EU-C-mini, EU-R-9s, EU-R-9b, EU-R-9z etc.
- one 230V output for a pump
- control of the heating or cooling device via voltage-free contact
- possibility of connecting EU-M-9 control panel
- possibility of controlling the mixing valve (via EU-i-1, EU-i-1m valve module)
- possibility of updating the software via USB
- possibility of setting up an individual operation schedule for each zone
- weather-based control
- control of wireless window sensors (up to 6 per zone)
- control of floor temperature sensor
- control of wireless STT-868, STT-869 or EU-G-X actuators (up to 6 per zone)

Devices for the expansion of the system are updated on an ongoing basis on our website [www.tech-controllers.com](http://www.tech-controllers.com).

## III. HOW TO INSTALL THE CONTROLLER

EU-L-9r controller should be installed by a qualified person.



### WARNING

- Risk of fatal electric shock from touching live connections. Before working on the controller switch off the power supply and prevent it from being accidentally switched on.
- Incorrect connection of cables may lead to controller damage.

### WARNING

If pump manufacturer requires an external main switch, power supply fuse or additional residual current device selective for distorted currents it is recommended not to connect pumps directly to pump control outputs.

To avoid damaging to the device, an additional safety circuit must be used between the regulator and the pump. The manufacturer recommends the ZP-01 pump adapter, which must be purchased separately.

## IV. FIRST START-UP

Follow these steps while starting the device for the first time to ensure its failure-free operation:

### Step 1. Connect EU-L-9r controller with all the devices to be controlled

In order to connect the wires, remove the controller cover and connect the cables according to the connector labels and the schemes below.



### NOTE

There are two ways of establishing main RS communication between external controllers and between EU-M-9r panel and external controller: with the use of RJ jack or with the use of a 4-pin pluggable terminal block.

Pictorial diagram of wiring up and communication between the devices in the system:

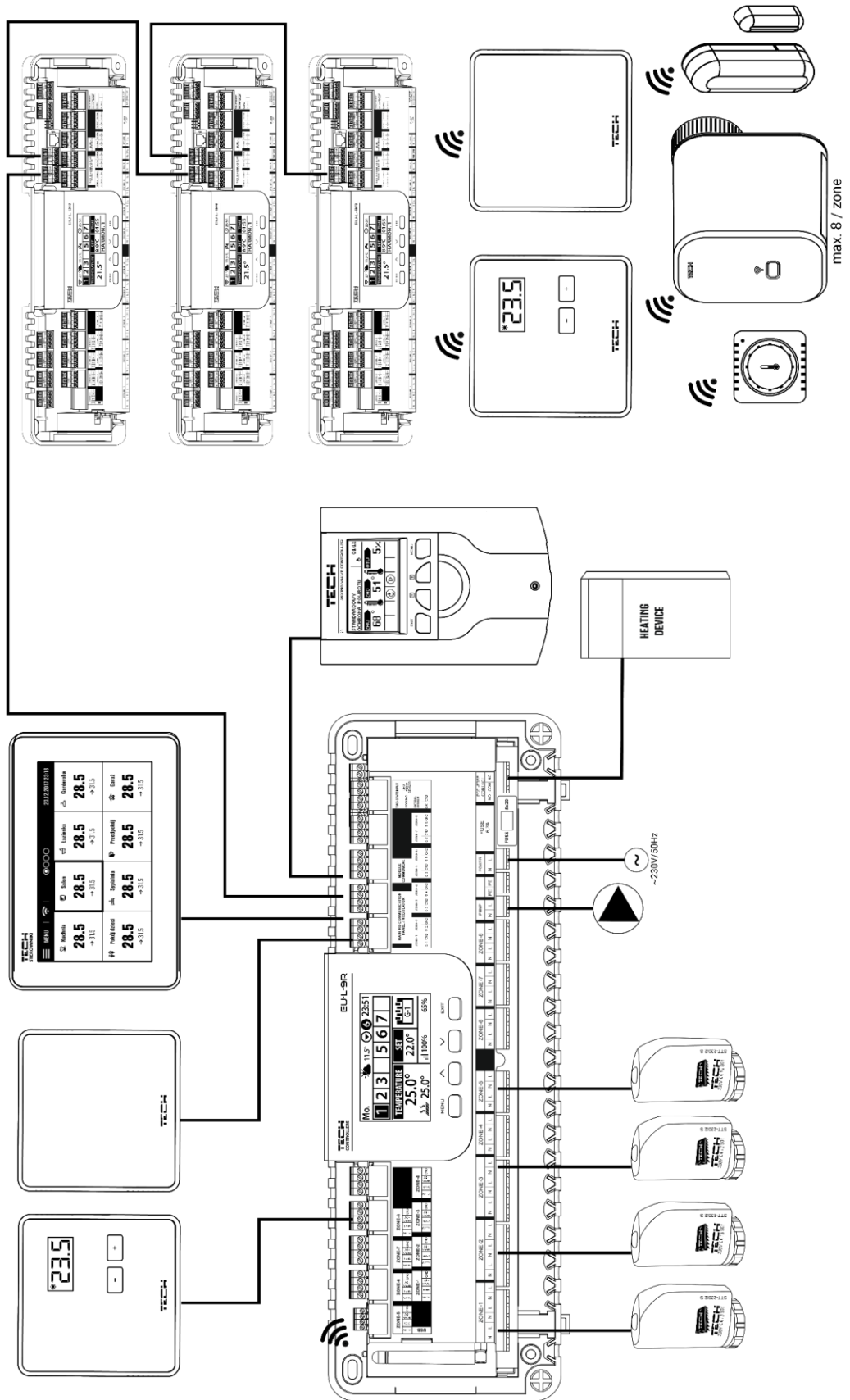





Scheme illustrating connection and communication between devices in the system using a pluggable terminal block:

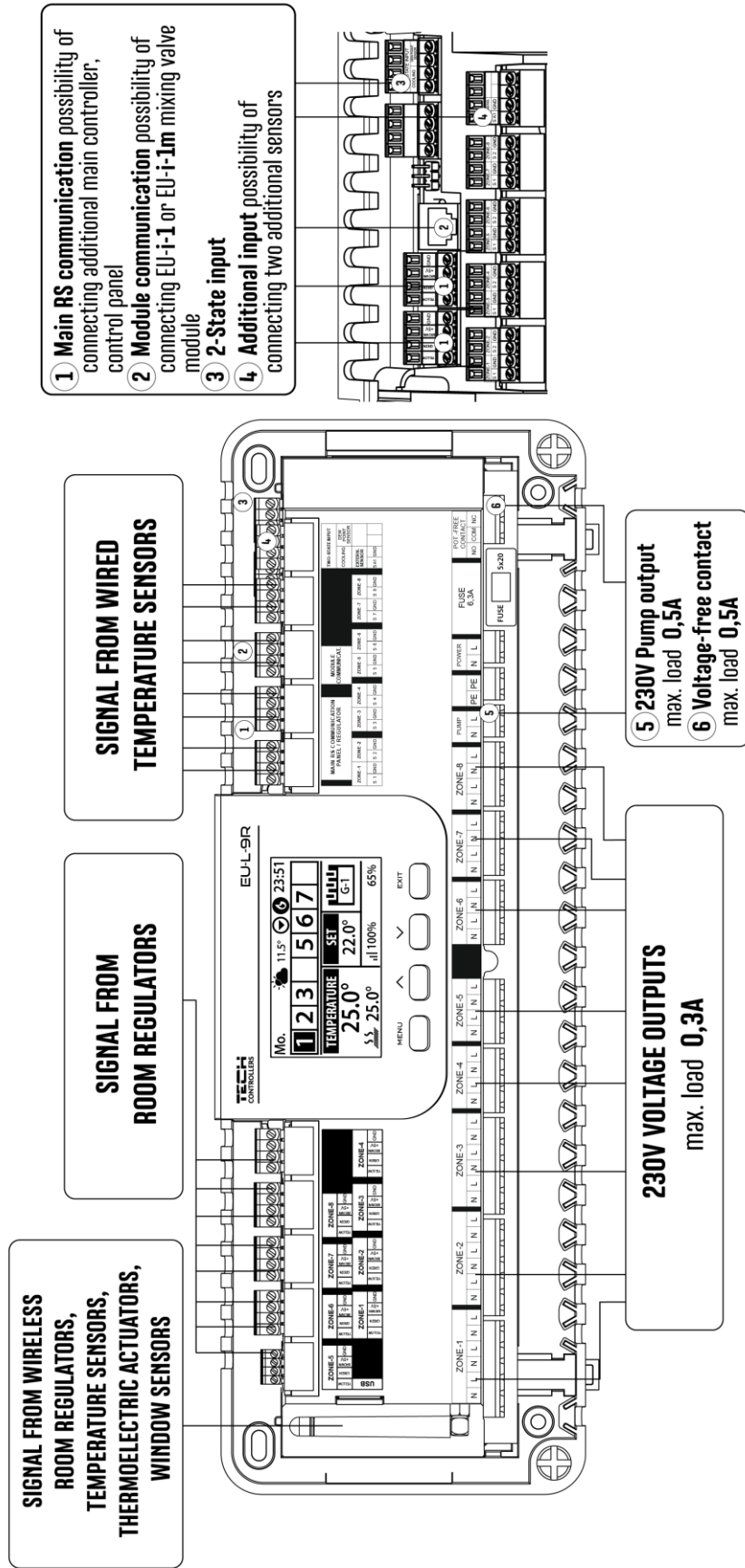

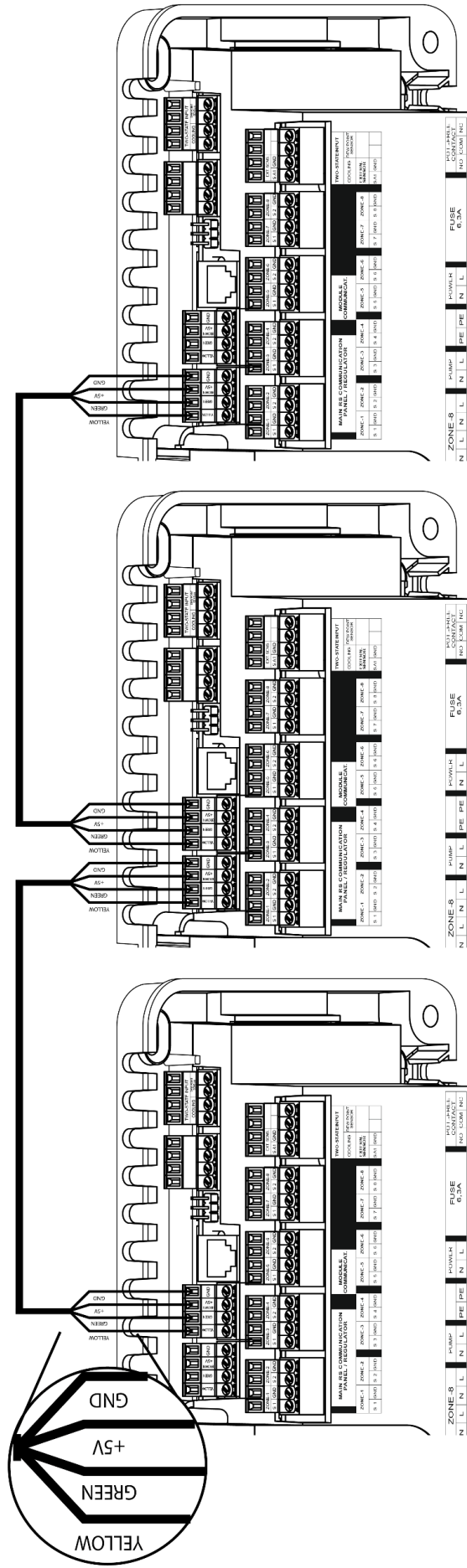

**Step 2. Switch on the power supply and check if the devices work properly**

Once all the devices has been connected, switch on the power supply.

Use the Manual mode function to check if each device works properly - use the buttons ▲ ▼ to select the device and press MENU button - the device should be activated. Follow the procedure to check all the devices.

**Step 3. Set current time and date**

Set current date and time - use the parameters in MENU --> Time settings.

**Krok 4. How to configure temperature sensors or a control panel**

To enable EU-L-9r external controller to control a given zone, it is necessary to provide it with current temperature value. The easiest way is to use temperature sensor EU-C-8r, EU-R-8b or EU-C-mini. If the user wants to be able to change the pre-set temperature value directly from the zone, it is advisable to use EU-R-9b, EU-R-9s or EU-R-9z.

It is possible to use EU-M-9r control panel. It serves as a master controller enabling the user to change the pre-set zone temperatures, adjust the local and global weekly schedules etc. Only one room regulator of this type may be installed in the heating system.

Room regulators must be registered in a particular zone in EU-L-9r controller menu.

**Krok 5. How to configure the remaining peripherals:**

EU- L-9r controller may cooperate with such devices as:

- STT-868, STT-869 or EU-G-X wireless actuators
- wireless window sensors
- floor sensor
- mixing valve

If the user wants to use such devices in the heating system, they should be connected and/or registered.

How to connect sensors and room regulators:

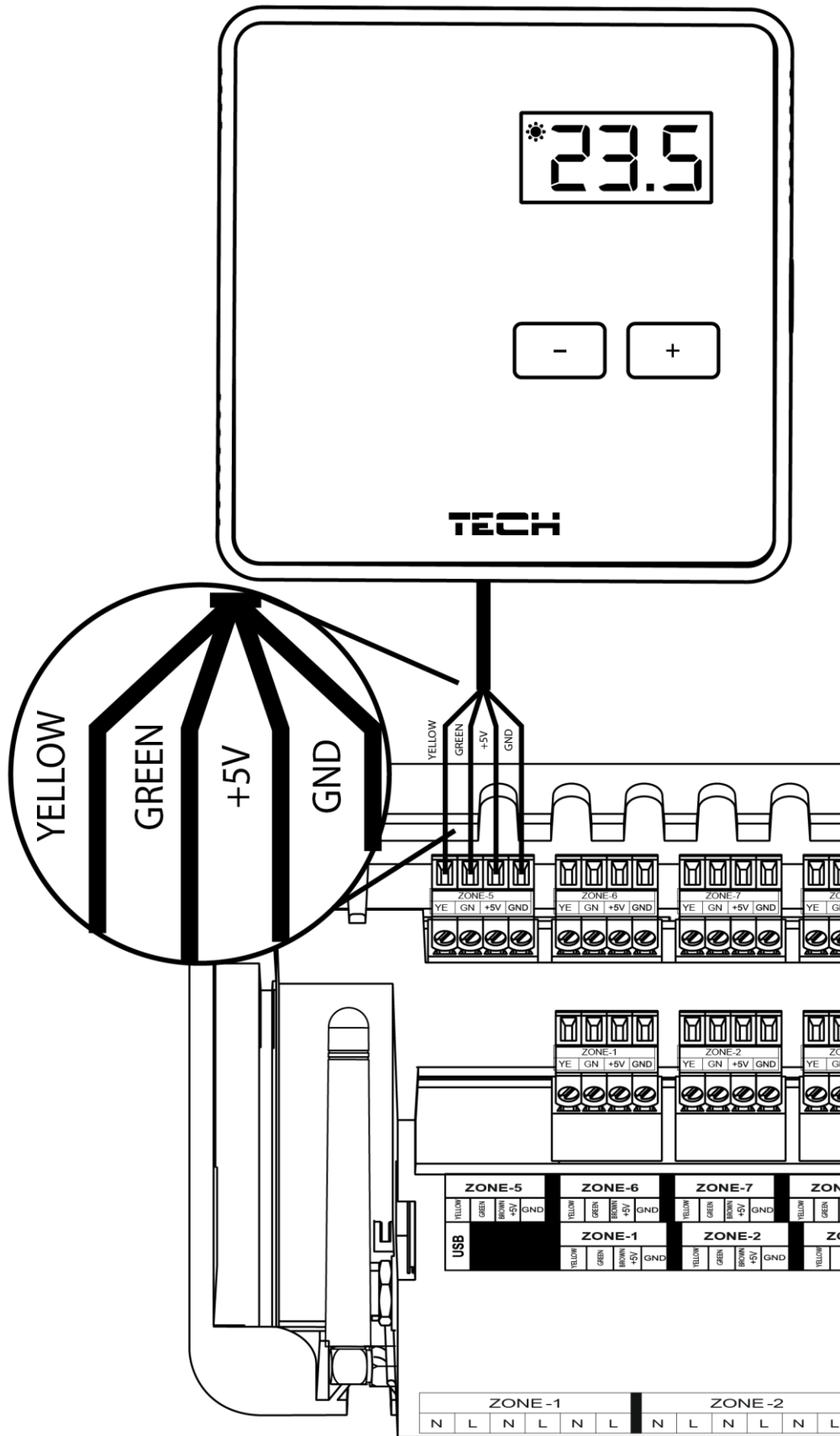

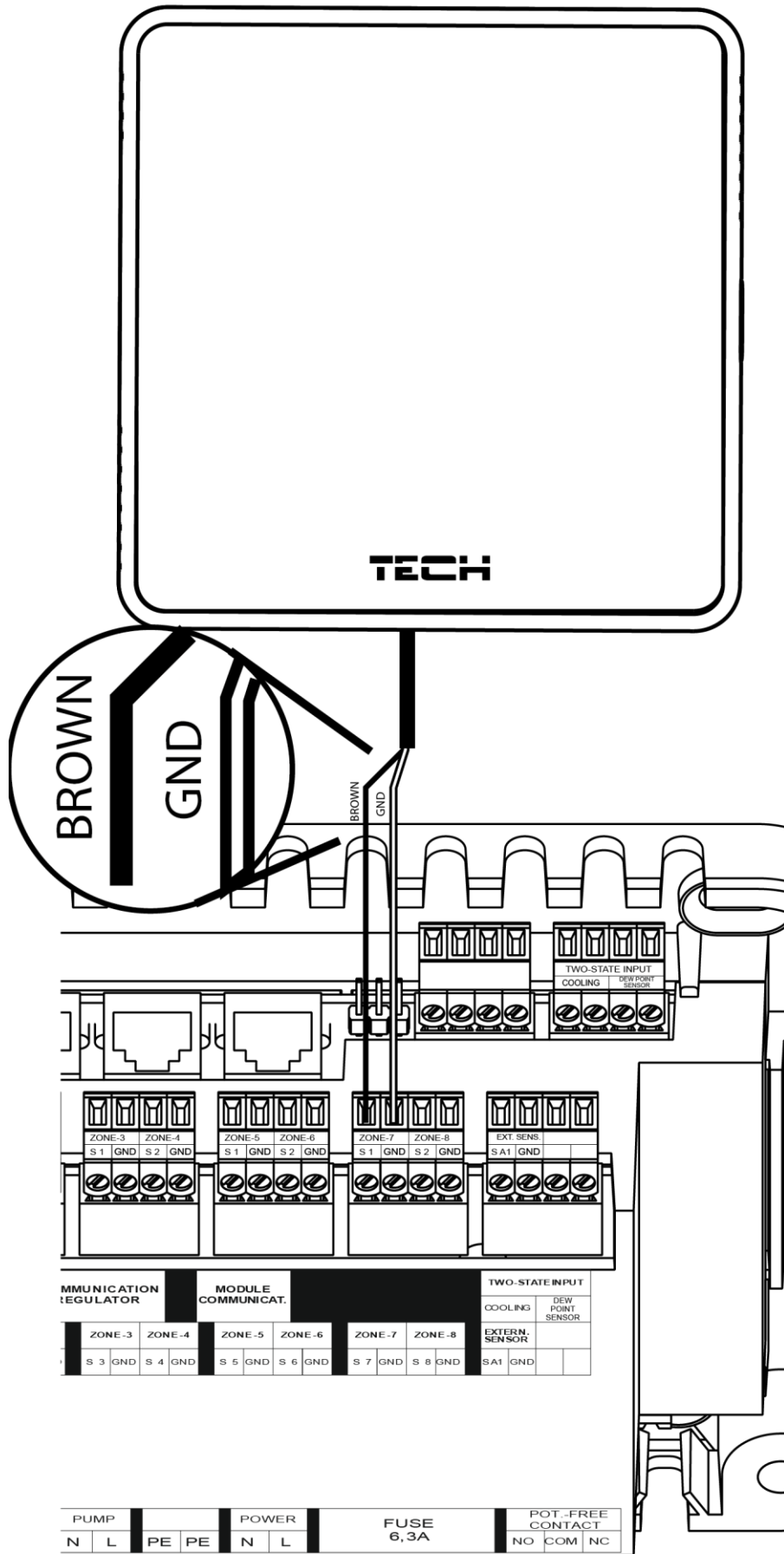

## V. MAIN SCREEN VIEW AND DESCRIPTION

The user navigates in the menu structure using the buttons located next to the display.

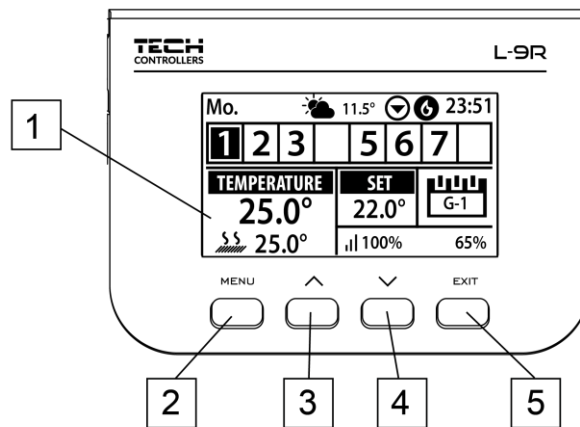

1. Display
2. ▲ - „up” „plus” – it is used to view the menu options and increase the value while editing parameters. During standard operation the button is used to switch between different zones parameters.
3. ▼ - „down” „minus” - it is used to view the menu options and decrease the value while editing parameters. During standard operation the button is used to switch between different zones parameters.
4. MENU button – it is used to enter the controller menu and confirm the new settings.
5. EXIT button – it is used to exit the menu and cancel the settings.

### Example screen – zones view

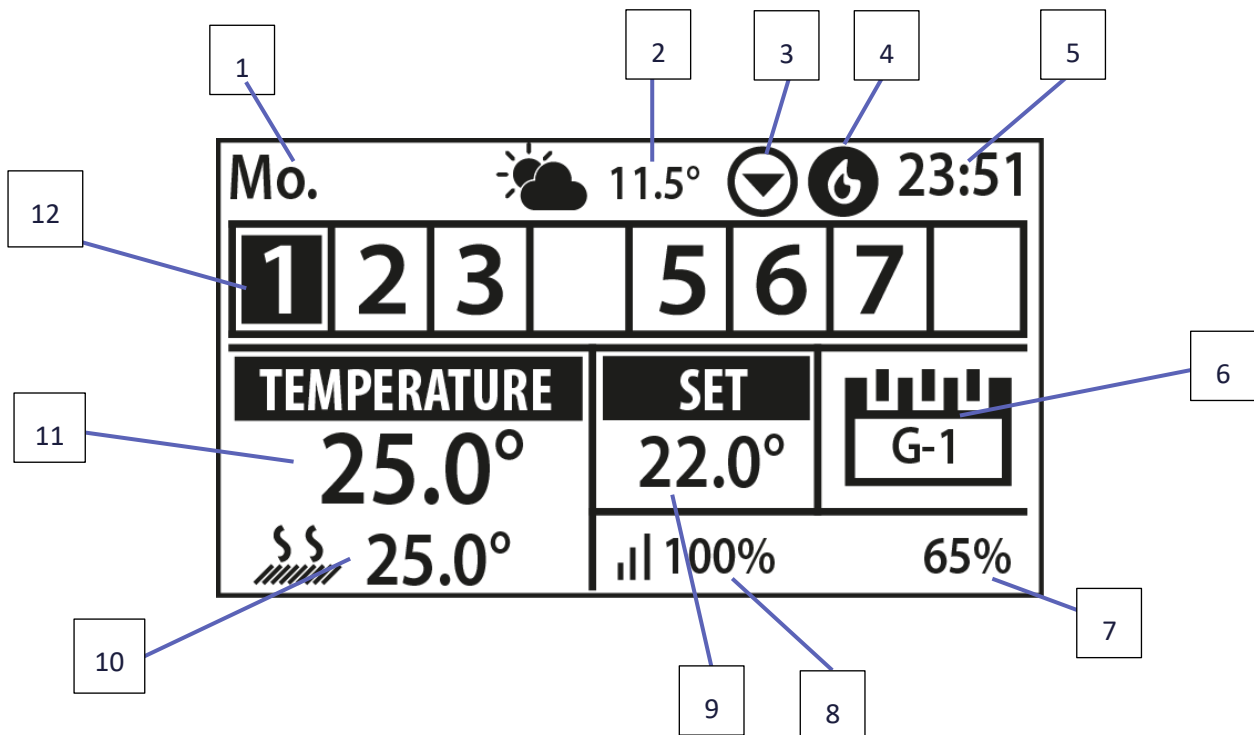

1. Current day of the week
2. External temperature
3. Pump ON
4. Voltage-free contact ON ( (heating = flame icon; cooling = fan icon).
5. Current time
6. Current operation mode in the zone
7. Sensor battery level in a given zone (highlighted number on the zone information bar - description no. 12).
8. Signal strength of the temperature sensor in a given zone (highlighted number on the zone information bar - description no. 12).
9. Pre-set temperature in a given zone (highlighted number on the zone information bar - description no. 12).
10. Current temperature of the floor sensor in a given zone (highlighted number on the zone information bar - description no. 12).
11. Current temperature of the room sensor in a given zone (highlighted number on the zone information bar - description no. 12).
12. Zone information. The digit displayed indicates the corresponding room sensor which is connected and sends current zone temperature readings. If the zone temperature is too low, the digit flashes. In the event of a zone alarm, an exclamation mark is displayed in the place of the digit. In order to view the operation parameters of a given zone, select its number using ▲ or ▼.

Example screen – zone view

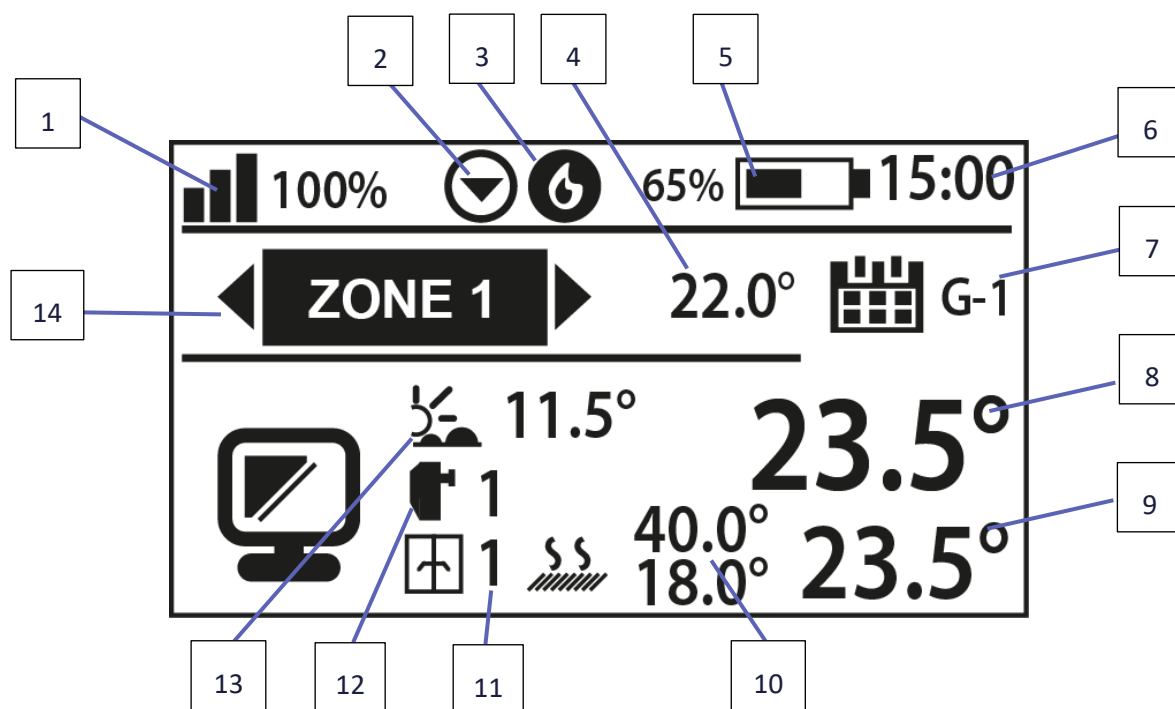

1. Signal strength of the temperature sensor in a given zone
2. Pump ON
3. Voltage-free contact ON ( (heating = flame icon; cooling = fan icon)
4. Pre-set temperature in a given zone
5. Sensor battery level in a given zone
6. Current time
7. Current operation mode in the zone
8. Current room temperature in a given zone

- 9. Current floor temperature in the given zone
- 10. Maximum and minimum floor temperature
- 11. Information about the number of window sensors registered in a given zone
- 12. Information about the number of thermostatic actuators registered in a given zone
- 13. External temperature
- 14. Zone name

## VI. CONTROLLER FUNCTIONS

### 1. BLOCK DIAGRAM – CONTROLLER MENU

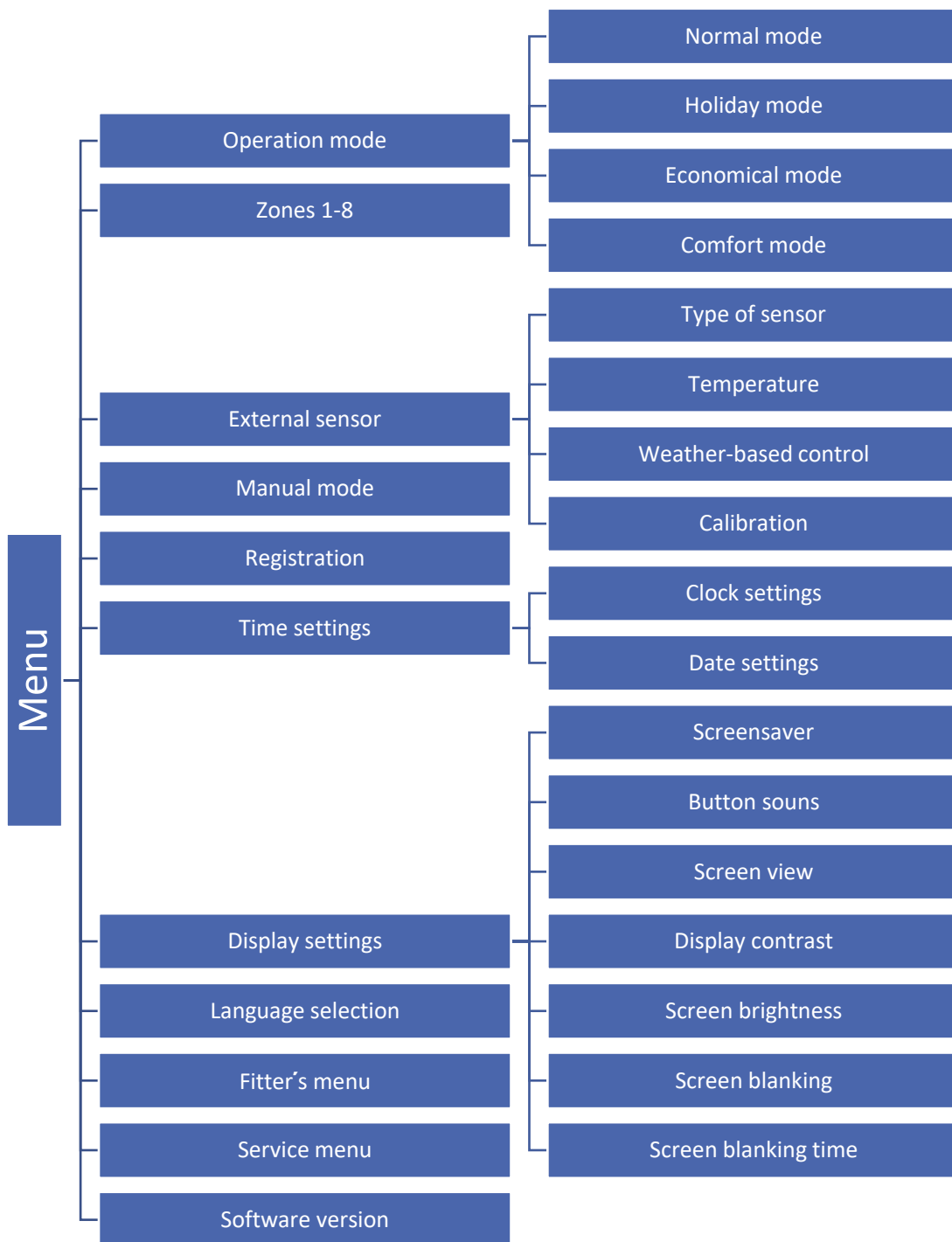



## 2. OPERATION MODE

This function enables the user to activate a given operation mode in the zone.

- **Normal mode** – pre-set temperature depends on the selected schedule.
- **Holiday mode** – the pre-set temperature depends on 'Temperature settings' parameter ( Menu > Zones > User's settings > Temperature settings > Holiday temperature).
- **Economical mode** – the pre-set temperature depends on 'Temperature settings' parameter ( Menu > Zones > User's settings > Temperature settings > Economical temperature).
- **Comfort mode** – the pre-set temperature depends on 'Temperature settings' parameter ( Menu > Zones > User's settings > Temperature settings > Comfort temperature).



### NOTE

Changing the mode to holiday, economical and comfort applies to all zones. It is possible to edit the pre-set temperature of the selected mode for a particular zone. In the operation mode other than normal, it is not possible to change the pre-set temperature from the level of a regulator.

## 3. ZONES

Zones menu is described in detail in section VII.

## 4. EXTERNAL SENSOR

It is possible to connect an external temperature sensor which enables the user to activate the weather-based control. The current external temperature value is displayed in the main screen view.

### 4.1. WEATHER-BASED CONTROL

Once the external sensor has been activated, the main screen displays external temperature value whereas the main menu offers average external temperature.

- **Averaging time** – the user sets the time period based on which the average external temperature is calculated. The settings range is 6-24 hours.
- **Temperature threshold** – this function protects the zone against excessive temperature. The zone in which weather-based control has been activated will not be heated when the average daily temperature outside exceeds the pre-set threshold value. For example, when the temperature rises in spring, the controller will prevent the zones from being heated unnecessarily.



### NOTE

In order for the L-9r controllers to operate in the weather-based control mode, it is necessary to use a separate outside temperature sensor for each controller.

### 4.2. CALIBRATION

Sensor calibration is performed while mounting or after it has been used for a long time, if the room temperature displayed differs from the actual temperature. Calibration range is from -10°C to +10°C with the accuracy of 0,1°C.

## 5. MANUAL MODE

This function enables the user to activate particular devices (pump, voltage-free contact and valve actuators) independently of the others in order to check if they operate properly. It is advisable to check the devices using this procedure at the first start-up.

## 6. REGISTRATION

This function is used to register EU-M-9r room regulator, which enables the user to extend the system to 4 external controllers and be able to control all the zones via the Internet.

Follow the steps to register EU-M-9r room regulator:

- Select *Registration* option in EU-M-9r
- Go to the menu of the external controller and select Registration (Menu > Registration)



### NOTE

It is possible to register up to four EU-L-9r external controllers to EU-M-9r regulator. In order for the registration process to be successful, it is necessary to register the external controllers one by one. If the registration process is activated in more than one external controller at a time, it will end up in failure.

## 7. TIME SETTINGS

This function is used to set current time and date which will be displayed in the main screen.

## 8. DISPLAY SETTINGS

This function enables the user to adjust the screen parameters to individual needs.

## 9. LANGUAGE SELECTION

This option is used to select the language version.

## 10. FITTER'S MENU

This menu is described in section VIII.

## 11. SERVICE MENU

In order to activate service options, it is necessary to enter a 4-digit code provided by TECH company.

## 12. SOFTWARE VERSION

When this option is selected, the display shows the logo of the CH boiler manufacturer and the controller software version.

# VII. ZONES

This submenu enables the user to configure operation parameters for particular zones. When the pre-set temperature value in a zone is reached, EU-L-9r controller labels the zone as sufficiently heated and the status remains unchanged until the temperature drops below the pre-set temperature by hysteresis value. When the temperature in all the zones is sufficient, the controller disables both the pump and the voltage-free contact.

The same happens in the cooling mode - until the temperature rises above the pre-set temperature plus the hysteresis value.

## 1. TYPE OF SENSOR

This function allows the user to select from an NTC wired sensor, an RS wired sensor and a wireless sensor.

## 2. PRE-SET TEMPERATURE

The pre-set temperature in a given zone depends on the settings of the selected operating mode in the zone. As a rule, the temperature results from the currently selected weekly schedule; however, the 'Pre-set temperature' function allows the user to set a separate temperature value for a specific period of time or permanently. After it has been set, the display shows a screen enabling the user to define the duration of this temperature. When the time is over, the pre-set temperature in a given zone depends on the previously set mode. The pre-set temperature value together with the time left are displayed on the main screen on an ongoing basis (see: description of the main screen).



### NOTE

If the duration of a given pre-set temperature is set as CON, this temperature will apply for an indefinite period of time.

## 3. OPERATION MODE

In this submenu, the user can view, edit or set the operation mode in a given zone. It is also possible edit weekly schedules here.

The user may set 6 weekly schedules in a given zone: 1 local schedule and 5 global schedules. The schedule temperature settings are common for heating and cooling; the type of schedule selected in a given mode is saved separately.

- **Local schedule - it is a weekly schedule assigned to a given zone only. It may be edited freely**
- **Global schedule 1-5** - these schedules have the same settings for all zones.
- **Constant temperature** – this function enables the user to define a separate pre-set temperature that will apply in the zone regardless of the time of the day.
- **With time limit** – this function is used to configure the pre-set temperature which will apply for a pre-defined period of time. When the time is over, the pre-set temperature in a given zone depends on the previously set mode (schedule or constant without time limit).

## 4. USER SETTINGS

---

### 4.1. HOUSE HEATING

This function enables the user to activate/deactivate house heating.

---

### 4.2. HEATING

- **ON** – this function enables the user to include/ exclude the zone in/from the heating algorithm.
- **Schedule settings** – this function enables the user to choose the schedule which will apply in a zone (local schedule, global schedule 1-5) during heating, if the zone operation is based on a schedule.
- **Constant temperature** – this function enables the user to define a separate pre-set temperature that will apply in the zone during heating, if the zone operation is based on a constant temperature.

---

### 4.3. COOLING

- **ON** - this function enables the user to include/ exclude the zone in/from the cooling algorithm

If the cooling function is enabled, the controller will end cooling action if the humidity in the respective zone is too high, i.e. if it exceeds the value of the maximum humidity preset in: Fitter's menu > Protection – Humidity > Max. humidity.

- **Schedule settings** – this function enables the user to choose the schedule which will apply in a zone (local schedule, global schedule 1-5) during cooling , if the zone operation is based on a schedule.
- **Constant temperature** – this function enables the user to define a separate pre-set temperature that will apply in the zone during cooling, if the zone operation is based on a constant temperature.
- **Humidity protection**– this function is used to protect the floor against dewfall (condensation). If the humidity in a given zone is higher than 'Max humidity' value defined in the fitter's menu, cooling will be disabled in this zone.

---

#### 4.4. TEMPERATURE SETTINGS

This function enables the user to define pre-set temperatures for three operation modes (Comfort mode, Economical mode and Holiday mode).

### 5. FLOOR HEATING

---

#### 5.1. REGISTRATION

Select 'Registration' in L-9r controller and press the communication button in the selected floor temperature sensor C-8f. If the registration has been successful, the EU-L-9r display will show an appropriate message and the control light on C-8f sensor will flash twice.

---

#### 5.2. INFORMATION

After selecting this option, information about the operating mode, battery status, range and type of registered sensor appears on the controller screen.

---

#### 5.3. OPERATION MODE

- **Floor protection** – This function serves to maintain the floor temperature below the maximum temperature value in order to protect the system against overheating. When the floor temperature reaches the maximum temperature, the zone heating is disabled.
- **Comfort profile** – this function serves to maintain comfort floor temperature. The controller monitors the floor temperature and disables the zone heating when zone temperature reaches the maximum temperature in order to prevent overheating. When the floor temperature drops below the pre-set minimum temperature, the zone heating will be enabled.



#### NOTE

The user may view current operation mode, floor temperature and the type of sensor in the information screen.

---

#### 5.4. MINIMUM TEMPERATURE

This parameter is used to define the threshold temperature protecting against cooling down of the floor. If the floor temperature drops below the pre-set minimum temperature, zone heating will be enabled.



#### NOTE

This function is available only when Comfort profile is selected as the operation mode.

---

## 5.5. MAXIMUM TEMPERATURE

Maximum floor temperature is a threshold value of floor temperature. If this value is exceeded, the contact will open (the device is disabled) regardless of current room temperature.

---

## 5.6. HYSTERESIS

**Hysteresis** – floor temperature hysteresis defines tolerance for the maximum and minimum temperature. The settings range is 0,1-5°C.

### **Example 1 – floor protection:**

Maximum floor temperature: 33°C                      Hysteresis: 2°C

When the floor temperature reaches 33°C, the relay is disconnected. It will be connected again at the temperature of 31°C.

If the floor temperature exceeds the pre-set maximum temperature, the relay will be disconnected and the floor heating will be disabled. The relay will be connected again when the floor temperature drops to the maximum temperature minus hysteresis.

### **Example 2 – Comfort mode:**

Minimum floor temperature:23°C                      Hysteresis: 2°C

When the floor temperature reaches 23°C, the relay is connected. It will be disconnected again at the temperature of 25°C.

If the floor temperature drops below the pre-set minimum temperature, the relay will be connected and the floor heating will be enabled. The relay will be disconnected again when the floor temperature reaches the minimum temperature plus hysteresis.

---

## 5.7. CALIBRATION

Floor sensor calibration should be performed while mounting or after the regulator has been used for a long time, if the external temperature displayed differs from the actual temperature. Calibration setting range is from -10°C to +10°C with the accuracy of 0,1°C.

## 6. HYSTERESIS

Room sensor hysteresis defines tolerance of the pre-set temperature in order to prevent undesired oscillation in case of small temperature fluctuation (within the range 0,1 ÷ 10°C with the accuracy of 0,1 °C. ).

## 7. CALIBRATION

Room sensor calibration should be performed while mounting or after the regulator has been used for a long time, if the external temperature displayed differs from the actual temperature. Calibration setting range is from -10°C to +10°C with the accuracy of 0,1°C.

## 8. THERMOSTATIC ACTUATORS

---

### 8.1. REGISTRATION

This option concerns wireless actuators STT-868, STT-869 or EU-G-X- the registration process is described in detail in the user manual for particular actuators.

---

## 8.2. VALVE ACTUATORS

This option is used to remove the actuators STT-868 , STT-869 or EU-G-X from the controller memory.

---

## 8.3. INFORMATION

After this option has been selected, the display shows information about the actuator version, battery level, range and the actuator opening level (%).

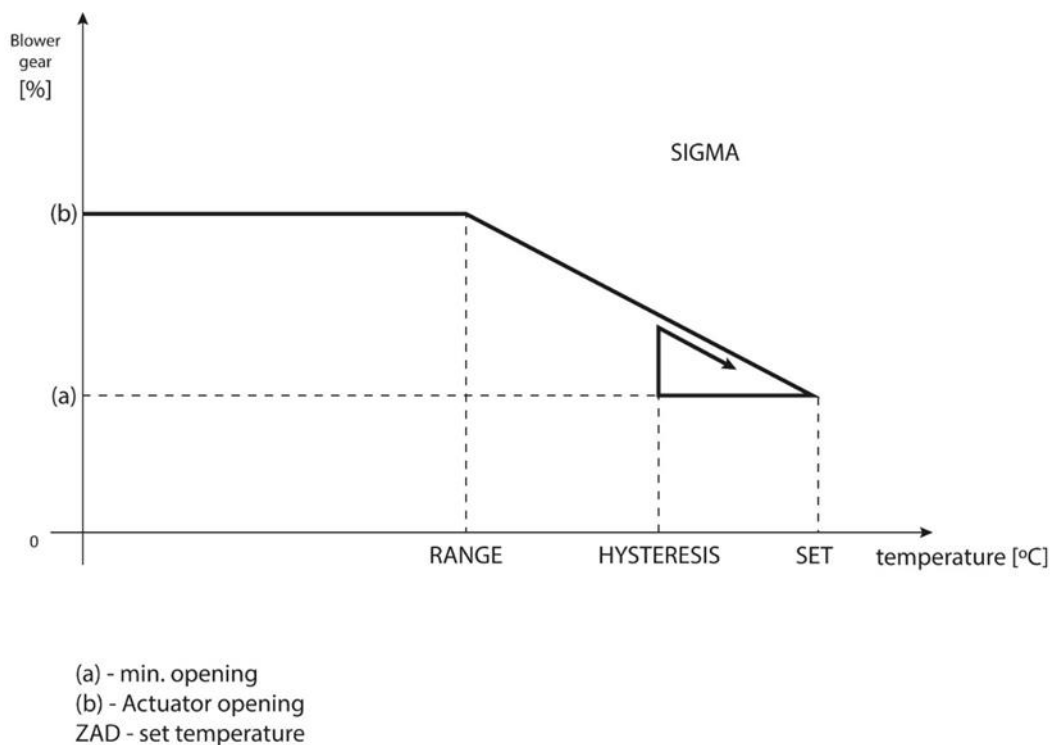

---

## 8.4. SETTINGS

- **Sigma** – function enables smooth control of the thermostatic actuator. The user may define the maximum and minimum valve opening – the level of valve opening and closing will never exceed these values. Moreover, the user configures *Range* parameter, which defines the room temperature at which the valve starts closing and opening.



### NOTE

SIGMA function is available only with STT-868 and STT-869 actuators.

### Example:

Pre-set zone temperature: 23°C

Minimum opening: 30%

Maximum opening: 90%

Range: 5°C

Hysteresis: 2°C

With the above settings, the valve starts closing if the zone temperature reaches 18°C (the pre-set value minus range). The minimum opening is reached when the zone temperature reaches the pre-set value.

After the pre-set value has been reached, the zone temperature starts falling. When it reaches 21°C (pre-set value minus hysteresis) the valve starts opening. It reaches the maximum opening when the zone temperature is 18°C.

- **Protection** - When this function is selected, the external controller monitors the temperature. If the pre-set temperature is exceeded by the value specified in <range> parameter, all actuators in a given zone will be closed (0% opening). This function is active only when sigma function has been activated.
- **Emergency mode** – This function enables the user to program valve opening, which will be performed in the event of an alarm in a given zone (sensor failure, communication error).

## 9. WINDOW SENSORS

### 9.1. REGISTRATION

In order to register a sensor, select *Registration* option in the controller EU-L-9r and quickly press the communication button on the window sensor. Release the button and watch the control light.

- the control light flashes twice - successful communication
- the control light goes on permanently - no communication with the main controller

### 9.2. SENSOR REMOVAL

This function is used to remove the sensors from a given zone.

### 9.3. INFORMATION

After this option has been selected, the display shows information about the actuator version, battery level, range and the actuator opening level (%).

### 9.4. SETTINGS

- **ON** – this function is used to enable the window sensor (it is possible only after the sensor has been registered).
- **Delay time** – this function enables the user to set the delay time. When the delay time is over, the main controller responds to window opening by disabling heating or cooling in a given zone.

**Example:** Delay time is set at 10 minutes. When the window is opened, the sensor sends a signal to the main controller. From time to time the sensor sends information about current status of the window. If the window is still open when the delay time is over (10 minutes), the main controller closes the actuators and disables the heating in a given zone.



#### NOTE

If the delay time is set at 0, the controller will immediately send a signal to the actuators in order to close them.

## VIII. FITTER'S MENU

Fitter's menu is intended to be used by a qualified person in order to configure advanced controller settings.

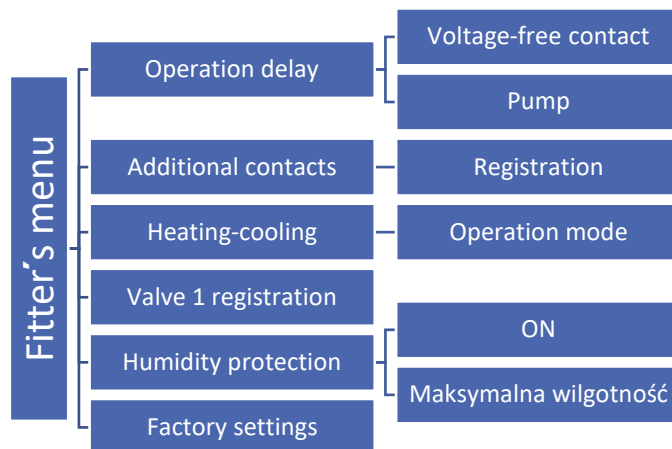

### 1. CONTACT OPERATION MODE VOLTAGE-FREE CONTACT

The regulator will enable the voltage-free contact after the pre-defined delay time if any of the zones has not reached the pre-set temperature (heating - if the temperature is too low; cooling - if the temperature is too high). The controller disables the contact when the pre-set temperature has been reached.

- **Operation delay** - the function allows the user to set the delay time of activating the additional contact after the temperature drops below the pre-set value in any of the zones.
- **Remote operation** - this function allows the user to enable a given contact from other controller which is registered in EU-M-9 control panel.

#### 1.1. PUMP

EU-L-9r controls the pump operation - it enables the pump after the pre-defined delay time if any of the zones has not reached the pre-set temperature. When all the zones reach the pre-set temperature, the pump is disabled.

- **Operation delay** - funkcja pozwala użytkownikowi ustawić czas opóźnienia włączenia pompy po spadku temperatury poniżej zadanej w którejkolwiek ze stref. Opóźnienie załączenia pompy stosowane jest po to aby siłownik zaworu zdążył się otworzyć.
- **Remote operation** - this function allows the user to enable a pump from other controller which is registered in EU-M-9 control panel.
- **Pump anti-stop** – this function forces pump operation and prevents scale deposit outside the heating season when the pump inactivity periods are long. When it is active, the valve pump is enabled for 5 minutes every 10 days .

### 2. ADDITIONAL CONTACTS

#### 2.1. REGISTRATION

Follow these steps to register module:

- Select registration option in the EU-L-9r controller
- Press the registration button in the MW-1 module



If:

- all control lights are flashing simultaneously = the registration has been successful
- the control lights are flashing one after another from one side to the other = MW-1 module has not received the signal from the main controller
- all control lights light up continuously = the registration attempt failed.



#### NOTE

It is possible to register the maximum of 6 MW-1 modules.

After registering MW-1 module, the following options appear:

- **Information** – the controller screen shows information about the status, operation mode, range and delay time.
- **ON/OFF**
- **Delay time** – the regulator enables the contact after the pre-defined delay time if any of the zones has not reached the pre-set temperature. When all the zones reach the pre-set temperature, the contact is disabled.
- **Operation mode** – this function enables the user to activate the operation mode in a given zone 1-8, voltage-free contact , pump or DHW.

### 3. HEATING - COOLING

This function enables the user to select the operation mode:

- **Heating** – all the zones are heated.
- **Cooling** – all the zones are cooled
- **Automatyczny** – Selecting between heating and cooling.

### 4. VALVE SETTINGS

EU-L-9r may control an additional valve via a valve module (e.g. i-1m). The regulators connect using RS communication but the registration process is necessary. There is a range of parameters enabling the user to adjust the valve operation to individual needs.

Configuring additional valve parameters is possible after the valve has been properly registered by entering the module number (found on the rear part of the module housing or in software version screen).

---

#### 4.1. ON/OFF

This function enables the user to enable or disable the valve.

---

#### 4.2. PRE-SET VALVE TEMPERATURE

This function is define the pre-set valve temperature. The temperature is read from the valve sensor.

---

#### 4.3. CALIBRATION

This function enables the user to calibrate the built-in valve at any time. During this process the valve is restored to its safe position – in the case of CH valve it is fully opened whereas in the case of floor valve it is closed.

---

#### 4.4. SINGLE STROKE

This is the maximum single stroke (opening or closing) that the valve may make during one temperature sampling. The smaller the single stroke, the more precisely the set temperature can be achieved. However, it takes longer for the set temperature to be reached.

---

#### 4.5. MINIMUM OPENING

The parameter determines the smallest valve opening. Thanks to this parameter, the valve may be opened minimally, to maintain the smallest flow.

---

#### 4.6. OPENING TIME

This parameter defines the time needed for the valve actuator to open the valve from 0% to 100% position. This value should be adjusted to the value given on the actuator rating plate.

---

#### 4.7. MEASUREMENT PAUSE

This parameter determines the frequency of water temperature measurement (control) downstream of the CH valve. If the sensor indicates a change in temperature (deviation from the pre-set value), the electric valve will open or close by the pre-set stroke, in order to return to the pre-set temperature.

---

#### 4.8. VALVE HYSTERESIS

This option is used to set the hysteresis of the pre-set valve temperature. It is the difference between the pre-set (desired) temperature and the temperature at which the valve will start closing or opening.

*Example:*

<b>Pre-set valve temperature</b>	<b>50°C</b>
<b>Hysteresis</b>	<b>2°C</b>
<b>Valve stops at</b>	<b>50°C</b>
<b>Valve closing</b>	<b>52°C</b>
<b>Valve opening</b>	<b>48°C</b>

*When the pre-set temperature is 50°C and the hysteresis value is 2°C, the valve stops in one position when the temperature of 50°C is reached. When the temperature drops to 48°C, the valve starts opening. When the temperature of 52°C is reached, the valve starts closing in order to reduce the temperature.*

---

#### 4.9. VALVE TYPE

This option is used to select the valve type:

- **CH** – select this option if you want to control CH circulation temperature.
- **FLOOR** – select this option if you want to control the floor heating temperature. It protects the underfloor heating installation against dangerous temperature. If the user selects CH as the valve type and connects it to the underfloor heating system, the fragile floor installation may be damaged.

---

#### 4.10. WEATHER – BASED CONTROL

For the function of weather control to be active, the external sensor mustn't be exposed to sunlight or influenced by the weather conditions. After it is installed in an appropriate place, <Weather-based control> function needs to be activated in the controller menu.

In order for the valve to operate correctly, the user defines the pre-set temperature for 4 intermediate external temperatures: -20°C, -10°C, 0°C and 10°C. The user selects external temperature value using LEFT and RIGHT arrows and defines a corresponding pre-set temperature value using DOWN and UP arrows.

**Heating curve** – a curve according to which the pre-set controller temperature is determined, on the basis of external temperature. In our controller, this curve is constructed on the basis of four pre-set temperatures. The more points constructing the curve, the greater its accuracy, which allows its flexible shaping. In our opinion, four points seem a very good compromise ensuring decent accuracy and easiness of setting the course of this curve.



#### NOTE

After weather-based control has been activated, <Pre-set valve temperature > parameter is not available.

---

#### 4.11. ROOM REGULATOR

This submenu is used to configure the parameters of room regulator which is to control the valve.

**Room regulator function is not available in cooling mode.**

---

#### 4.12. PROPORTIONALITY COEFFICIENT

Proportionality coefficient is used for defining valve stroke. The closer to the pre-set temperature, the smaller the stroke. If the coefficient value is high, the valve takes less time to open but at the same time the opening degree is less accurate. The following formula is used to calculate the percent of a single opening:

$$(\text{PRE-SET\_TEMP} - \text{SENSOR\_TEMP}) * (\text{PROP\_COEFF} / 10)$$

---

#### 4.13. OPENING DIRECTION

If, after connecting the valve to the controller, it turns out that it is connected the other way round, then the power supply cables do not have to be switched. Instead, it is enough to change the opening direction in this parameter: LEFT or RIGHT.

---

#### 4.14. RETURN PROTECTION

This function enables the user to set boiler protection against too cool water returning from the main circulation, which could cause low-temperature boiler corrosion. The return protection involves closing the valve when the temperature is too low, until the short circulation of the boiler reaches an appropriate temperature level. Once it is activated, the user presets the minimum acceptable return temperature.

---

#### 4.15. VALVE PUMP

- Pump operation modes

This option is used to select the pump operation mode.

- Always ON - the pump operates all the time, regardless of temperatures.
- Always OFF - the pump is permanently deactivated and the regulator controls only valve operation

- ON above threshold - the pump is activated above the pre-set activation temperature. If the pump is to be activated above the threshold, the user should also define the *threshold temperature of pump activation*. The temperature is read from CH sensor.
- **Deactivation threshold\***- the pump is enabled below the pre-set deactivation temperature measured on CH sensor. Above the pre-set value the pump is disabled.

**\*Deactivation threshold function is available after selecting *Cooling* as the valve type.**

- Pump switch on temperature

This option concerns the pump operating above the threshold (see: above). The valve pump is switched on when the CH boiler reaches the pump activation temperature.

- Pump anti-stop

When this function is active, the valve pump is activated every 10 days for 2 minutes. It prevents stagnant water in the heating system outside the heating season.

- Closing below temp. threshold

Once this function is activated (by selecting ON), the valve remains closed until the CH boiler sensor reaches the pump activation temperature.

- Valve pump room regulator

When this option is active, the room regulator disables the pump when the pre-set temperature has been reached.

- Only pump

When this option is active, the regulator controls only the pump while the valve is not controlled.

#### 4.16. VALVE REMOVAL

This option is used to remove the valve from the controller memory. Valve removal is used e.g. at disassembling the valve or module replacement (re-registration of a new module is necessary).

#### 4.17. FACTORY SETTINGS

This parameter is used to restore the factory settings of a given valve.

### 5. HUMIDITY PROTECTION

If the current humidity value is higher than the pre-set maximum humidity (fitter's menu -> protection - humidity -> Maximum humidity), cooling in the given zone will be disabled. The function is activated for particular zones (Zones -> Zone 1 -> User settings -> Cooling -> Humidity protection).

Additionally, through a two-state humidity sensor (the input located next to the heating / cooling) it is possible to disable cooling altogether in the master controller, in all the zones where the humidity protection option is on. (Zones -> Zone 1 -> User settings -> Cooling -> Humidity protection). The function is active only when the Humidity protection option is enabled (fitter's menu -> protection - humidity -> ON).

### 6. FACTORY SETTINGS

Once the Factory settings option is activated, all customized settings are lost and replaced with the manufacturer's settings.

## IX. SCHEDULE SETTINGS

Once the schedule has been selected (Menu -> Zones -> Zone 1-8 -> Weekly control), the user may select, view and edit a given schedule.

Schedule view screen:

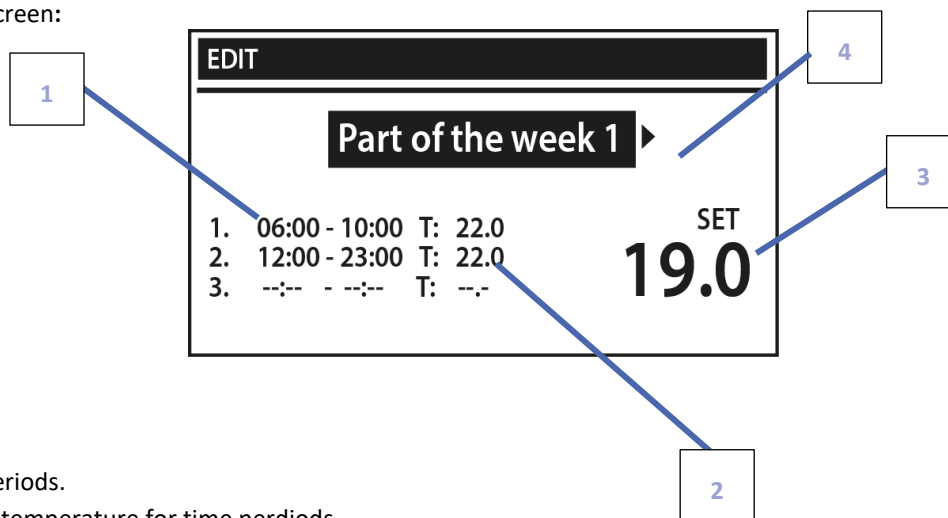

1. Time periods.
2. Pre-set temperature for time periods.
3. Pre-set temperature outside time periods.
4. Days when the above settings will apply.

Follow these steps to configure a schedule:

- Select the part of the week when the daily schedule will apply (part 1 or part 2).

In order to assign days to a given part of the week, follow the steps:

- Use arrows UP and DOWN to select <Assign days>. Press MENU in order to edit.

- Use arrows UP and DOWN to switch between days. Confirm by pressing MENU. Active days are highlighted in white.

- In order to confirm the settings, press EXIT and select <Confirm> and move on to editing daily schedule.

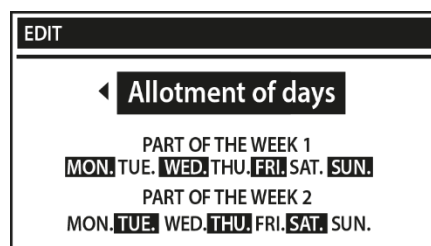
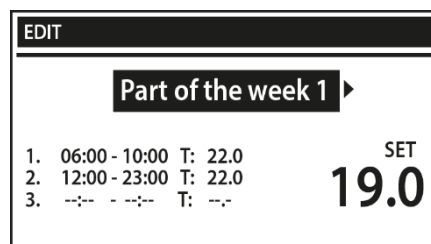

- Use arrows UP and DOWN to select the pre-set temperature to apply outside the time periods. Confirm by pressing MENU.
- Use arrows UP and DOWN to select the starting time of the first time period. Confirm by pressing MENU.
- Use arrows UP and DOWN to select the finishing time of the first time period. Confirm by pressing MENU.
- Use arrows UP and DOWN to select the pre-set temperature to apply within this time period. Confirm by pressing MENU.

**NOTE**

The user may program 3 different time periods in a given schedule (with the accuracy of 15 minutes).

When the schedule for all days of the week is ready, confirm the settings using EXIT button and select <Confirm>. Active option will be highlighted in white.

## X. SOFTWARE UPDATE

In order to install new software, the controller must be unplugged from the power supply. Next, insert the memory stick with the new software into the USB port. Connect the controller to the power supply at the same time holding EXIT button. It is necessary to hold EXIT button until a single sound signal is heard – it signals that the software update process has been initiated. After it has been completed, the controller restarts automatically.

**NOTE**

Software update shall be conducted only by a qualified fitter. After the software has been updated, it is not possible to restore previous settings.

**NOTE**

Do not switch the controller off while updating the software.

## XI. TECHNICAL DATA

Power supply	230V +/-10% / 50Hz
Maximum power consumption	4W
Ambient temperature	5÷50°C
Potential contacts 1-8 max. output load	0,3 A
Pump max. output load	0,5 A
Pot.-free cont. nom. out. load	230V AC / 0,5A (AC1) * 24V DC / 0,5A (DC1) **
NTC sensor thermal resistance	-30÷50°C
Operation frequency	868MHz
Fuse	6,3 A

\* AC1 load category: single-phase, resistive or slightly inductive AC load

\*\* DC1 load category: direct current, resistive or slightly inductive load.

## XII. PROTECTIONS AND ALARMS

Alarm	Possible cause	How to fix it
Sensor damaged (room sensor, floor sensor)	Sensor damaged	<ul style="list-style-type: none"> <li>- Check the connection between the sensor and the controller</li> <li>- Replace the sensor with a new one, contact the service staff if necessary.</li> </ul>
No communication with sensor/wireless regulator	<ul style="list-style-type: none"> <li>- No range</li> <li>- No batteries</li> <li>- Flat batteries</li> </ul>	<ul style="list-style-type: none"> <li>- Put the sensor/regulator in a different place</li> <li>- Insert batteries in the sensor/regulator</li> </ul> <p>After the communication is reestablished, the alarm is deactivated automatically.</p>
Alarm - No communication with module/wireless contact	<ul style="list-style-type: none"> <li>- No range</li> </ul>	<ul style="list-style-type: none"> <li>- Put the device in a different place or use a repeater to extend the range.</li> </ul> <p>After the communication is reestablished, the alarm is deactivated automatically.</p>
<b>STT-868 actuator alarm</b>		
ERROR #0	Flat battery in the actuator	Replace the batteries
ERROR #1	Some parts have been damaged	Call the service staff
ERROR #2	<ul style="list-style-type: none"> <li>- No piston controlling the valve</li> <li>- Too big stroke (movement) of the valve</li> <li>- The actuator has been incorrectly mounted on the radiator</li> <li>- Inappropriate valve on the radiator</li> </ul>	<ul style="list-style-type: none"> <li>- Install a piston controlling the actuator</li> <li>- Check the valve stroke</li> <li>- Install the actuator correctly</li> <li>- Replace the valve on the radiator</li> </ul>
ERROR#3	<ul style="list-style-type: none"> <li>- The valve got stuck</li> <li>- Inappropriate valve on the radiator</li> <li>- Too little stroke (movement) of the valve</li> </ul>	<ul style="list-style-type: none"> <li>- Inspect the valve operation</li> <li>- Replace the valve on the radiator</li> <li>- Check the valve stroke - Sprawdź skok zaworu</li> </ul>
ERROR #4	<ul style="list-style-type: none"> <li>- Out of range</li> <li>- No batteries</li> </ul>	<ul style="list-style-type: none"> <li>- The actuator is too far from the controller</li> <li>- Insert batteries into the actuator</li> </ul> <p>After the communication is reestablished, the alarm is deactivated automatically.</p>

<b>STT-869 actuator alarm</b>		
ERROR #1 - Calibration error 1 – Moving the screw to the mounting position took too much time	- The limit switch sensor is damaged	- Calibrate actuator again by holding the communication button until the third flash of green light - Call the service staff
ERROR #2 – Calibration error 2 – The screw is maximally pulled out. No resistance while pulling out	- The actuator has not been screwed to the valve or has not been screwed completely - The valve stroke is too big or the valve dimensions are not typical - Actuator current sensor is damaged	- Check if the controller has been installed properly - Replace the batteries - Calibrate actuator again by holding the communication button until the third flash of green light - Call the service staff
ERROR #3 – Calibration error 3 - The screw has not been pulled out enough - the screw meets resistance too early	- The valve stroke is too small or the valve dimensions are not typical - Actuator current sensor is damaged - Low battery level	- Replace the batteries - Call the service staff
ERROR #4 – No feedback	- The master controller is switched off - Poor range or no range in the master controller - Radio module in the actuator is damaged	- Check if the master controller is on - Reduce the distance from the master controller - Call the service staff
ERROR #5 – Low battery level	The battery is fl at	Replace the batteries
ERROR #6 – Encoder is locked	The encoder is damaged	- Calibrate actuator again by holding the communication button until the third flash of green light
ERROR #7 – To high voltage	- Unevenness of the screw, the thread etc. may cause excessive resistance - Too high resistance of gear or motor - Current sensor is damaged	- Call the service staff
ERROR #8 – Limit switch sensor error	Limit switch sensor damaged	
<b>EU-G-X actuator alarm</b>		
ERROR #1 - Calibration error 1	Bolt retraction to mounting position took too long.	Locked/damaged actuator piston. Check the assembly and recalibrate the actuator.
ERROR #2 - Calibration error 2	Bolt maximally extended as it did not meet any resistance during extension.	- actuator was not screwed properly onto the valve - the actuator was not fully tightened onto the valve - actuator movement was excessive, or non-standard valve encountered



		<ul style="list-style-type: none"> <li>- motor load measurement failure occurred</li> </ul> <p>Check the assembly and recalibrate the actuator.</p>
ERROR #3 - Calibration error 3	Bolt extension too short. The bolt met resistance too early during the calibration process.	<ul style="list-style-type: none"> <li>- valve movement was too small, or a non-standard valve encountered</li> <li>- motor load measurement failure</li> <li>- motor load measurement inaccurate due to low battery charge</li> </ul> <p>Check the assembly and recalibrate the actuator.</p>
ERROR #4 - Actuator feedback communication error.	<p>For the last x minutes, the actuator did not receive a data package via wireless communication.</p> <p>After this error is triggered, the actuator will set itself to 50% opening.</p> <p>The error will reset after a data package is received.</p>	<ul style="list-style-type: none"> <li>- master controller disabled</li> <li>- poor signal or no signal originating from the master controller</li> <li>- defective RC module in the actuator</li> </ul>
ERROR #5 - Battery low	The actuator will detect battery replacement after voltage rises and launch calibration	<ul style="list-style-type: none"> <li>- battery depleted</li> </ul>
ERROR #6	-	-
ERROR #7 - Actuator blocked		<ul style="list-style-type: none"> <li>- while changing the opening of the valve, excessive load was encountered</li> </ul> <p>Recalibrate the actuator.</p>



## EU Declaration of conformity

---

Hereby, we declare under our sole responsibility that **EU-L-9r** manufactured by TECH STEROWNIKI II Sp. z o.o., head-quartered in Wieprz Biała Droga 31, 34-122 Wieprz, is compliant with Directive **2014/53/EU** of the European parliament and of the Council of 16 April 2014 on the harmonisation of the laws of the Member States relating to the making available on the market of radio equipment, Directive **2009/125/EC** establishing a framework for the setting of ecodesign requirements for energy-related products as well as the regulation by the MINISTRY OF ENTREPRENEURSHIP AND TECHNOLOGY of 24 June 2019 amending the regulation concerning the essential requirements as regards the restriction of the use of certain hazardous substances in electrical and electronic equipment, implementing provisions of Directive (EU) 2017/2102 of the European Parliament and of the Council of 15 November 2017 amending Directive 2011/65/EU on the restriction of the use of certain hazardous substances in electrical and electronic equipment (OJ L 305, 21.11.2017, p. 8).

For compliance assessment, harmonized standards were used:

PN-EN IEC 60730-2-9 :2019-06 art. 3.1a Safety of use

PN-EN 62479:2011 art. 3.1 a Safety of use

ETSI EN 301 489-1 V2.2.3 (2019-11) art.3.1b Electromagnetic compatibility

ETSI EN 301 489-3 V2.1.1:2019-03 art.3.1 b Electromagnetic compatibility

ETSI EN 300 220-2 V3.2.1 (2018-06) art.3.2 Effective and coherent use of radio spectrum

ETSI EN 300 220-1 V3.1.1 (2017-02) art.3.2 Effective and coherent use of radio spectrum

PN EN IEC 63000:2019-01 RoHS.

Wieprz, 24.05.2023

  
Paweł Jura

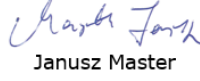
  
Janusz Master

Prezisi firmy



**TECH  
TECH  
CONTROLLERS**

**Central headquarters:**

ul. Biała Droga 31, 34-122 Wieprz

**Service:**

ul. Skotnica 120, 32-652 Bulowice

phone: **+48 33 875 93 80**

e-mail: **serwis@techsterowniki.pl**

**[www.tech-controllers.com](http://www.tech-controllers.com)**