

TECH TECH CONTROLLERS

USER MANUAL

EU-T-4.1n

EU-T-4.2n

EN



www.tech-controllers.com

TABLE OF CONTENTS

- I. Safety 3
- II. Device description 4
- III. How to install the controller 4
 - 1. EU-T-4.1n connection diagram 6
 - 2. EU-T-4.2n connection diagram 7
- IV. EU-MW-3 receiver 7
- V. First start-up 8
- VI. How to use the regulator 8
 - 1. Principle of operation 8
 - 2. Operation modes 8
 - 3. Main screen view and description 10
 - 4. Controller functions 12
 - 4.1. Main menu 12
 - 4.2. Day of the week 12
 - 4.3. Clock 13
 - 4.4. Day from... 13
 - 4.5. Night from... 13
 - 4.6. Button lock 13
 - 4.7. Optimum start 13
 - 4.8. Automatic manual mode 14
 - 4.9. Weekly program 14
 - 4.10. Pre-set comfort temperature 15
 - 4.11. Pre-set economical temperature 15
 - 4.12. Pre-set temperature hysteresis 15
 - 4.13. Temperature sensor calibration 16
 - 4.14. Registration 16
 - 4.15. Service menu 16
- VII. Technical data 17

JG. 22.08.2023

*The pictures and diagrams are for illustration purposes only.
The manufacturer reserves the right to introduce some changes.*

I. SAFETY

Before using the device for the first time the user should read the following regulations carefully. Not obeying the rules included in this manual may lead to personal injuries or controller damage. The user's manual should be stored in a safe place for further reference.

In order to avoid accidents and errors it should be ensured that every person using the device has familiarized themselves with the principle of operation as well as security functions of the controller. If the device is to be sold or put in a different place, make sure that the user's manual is stored with the device so that any potential user has access to essential information about the device.

The manufacturer does not accept responsibility for any injuries or damage resulting from negligence; therefore, users are obliged to take the necessary safety measures listed in this manual to protect their lives and property.



WARNING

- **A live electrical device!** Make sure the regulator is disconnected from the mains before performing any activities involving the power supply (plugging cables, installing the device etc.)
- The device should be installed by a qualified electrician.
- The device should not be operated by children.



WARNING

- The device may be damaged if struck by a lightning. Make sure the plug is disconnected from the power supply during a thunderstorm.
- Any use other than specified by the manufacturer is forbidden.
- The device should be periodically checked.

Changes in the merchandise described in the manual may have been introduced subsequent to its completion on 22.08.2023. The manufacturer retains the right to introduce changes to the structure or colours. The illustrations may include additional equipment. Print technology may result in differences in the colours shown.

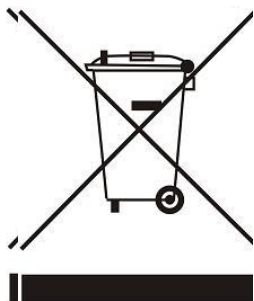

We are committed to protecting the environment. Manufacturing electronic devices imposes an obligation of providing for environmentally safe disposal of used electronic components and devices. Hence, we have been entered into a register kept by the Inspection for Environmental Protection. The crossed-out bin symbol on a product means that the product may not be disposed of to household waste containers. Recycling of waste helps to protect the environment. The user is obliged to transfer their used equipment to a collection point where all electric and electronic components will be recycled.

II. DEVICE DESCRIPTION

The EU-T-4.1N/EU-T-4.2N room regulator is intended for controlling the heating device (e.g. gas, oil or electric boiler or the boiler controller).

Its main task is to maintain the pre-set temperature in the flat by sending a signal to the heating/cooling device (contact opening) when the desired temperature is reached.

Advanced software enables the regulator to fulfil a wide range of functions:

- maintaining the pre-set room temperature
- manual mode
- day/night program
- weekly control
- Optimum Start
- heating/cooling
- button lock
- automatic manual mode

Controller equipment:

- front panel made of glass
- built-in temperature sensor
- batteries

Regulator versions:

- EU-T-4.1N – wired version
- EU-T-4.2N – wireless version (regulator + receiver EU-MW-3)

III. HOW TO INSTALL THE CONTROLLER

The controller should be installed by a qualified electrician.

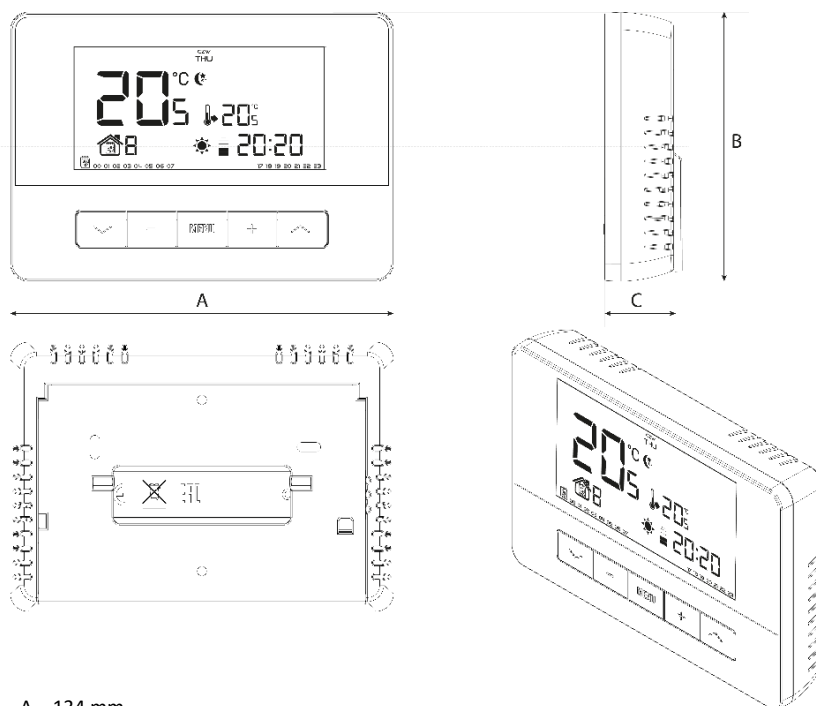

A – 134 mm
 B – 94 mm
 C – 24 mm

USER MANUAL

The EU-T-4.1N/EU-T-4.2N regulator may be put in any place (1) or used as a wall-mountable panel (2).

- 1) The regulator may be supported with a stand which should be attached to the back cover.

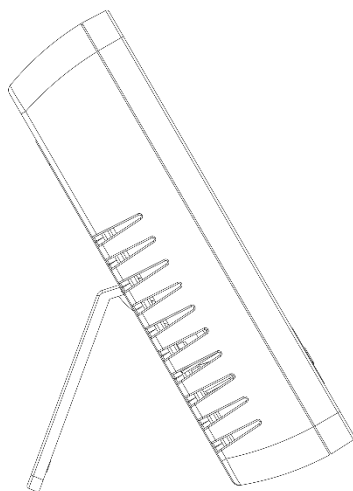

- 2) In order to hang the regulator on the wall, remove the stand carefully.

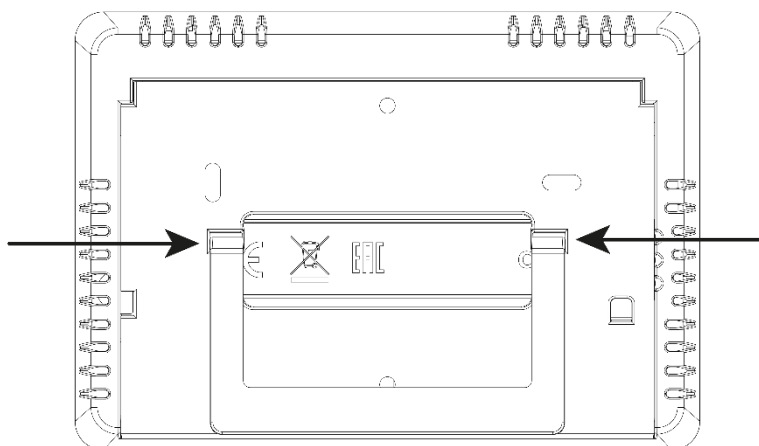

In order to insert batteries, remove the back cover.

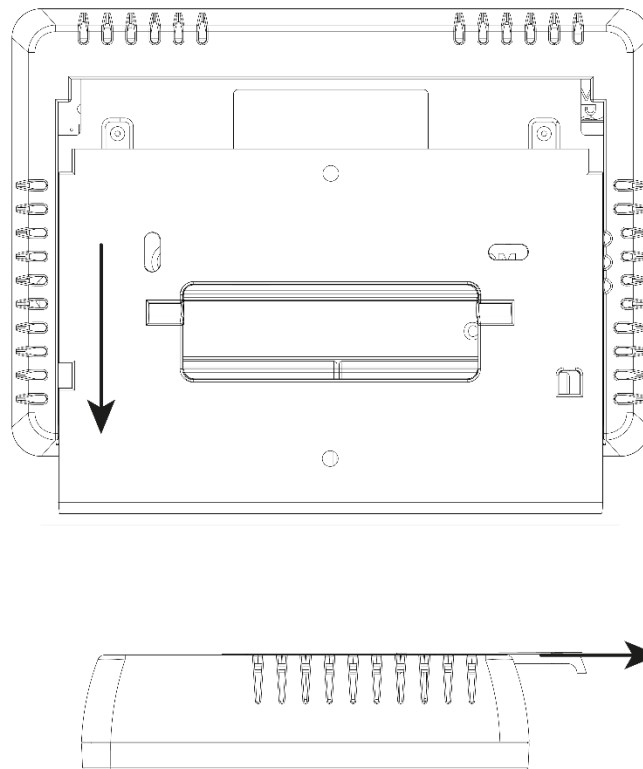

1. EU-T-4.1N CONNECTION DIAGRAM

The room regulator should be connected to the heating device or the CH boiler controller with the use of a two-core cable. The diagram below illustrates how to connect the devices.

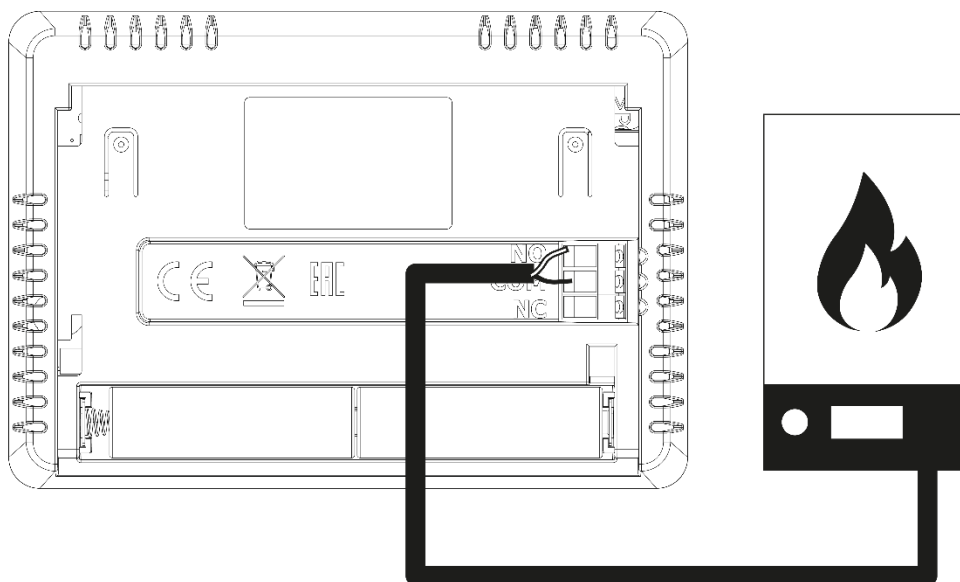

WARNING

If pump manufacturer requires an external main switch, power supply fuse or additional residual current device selective for distorted currents it is recommended not to connect pumps directly to pump control outputs. To avoid damaging to the device, an additional safety circuit must be used between the regulator and the pump. The manufacturer recommends the ZP-01 pump adapter, which must be purchased separately.

2. EU-T-4.2N CONNECTION DIAGRAM

In the case of wireless connection, use the above diagrams - a two-core communication cable should be connected to appropriate ports in the receiver.

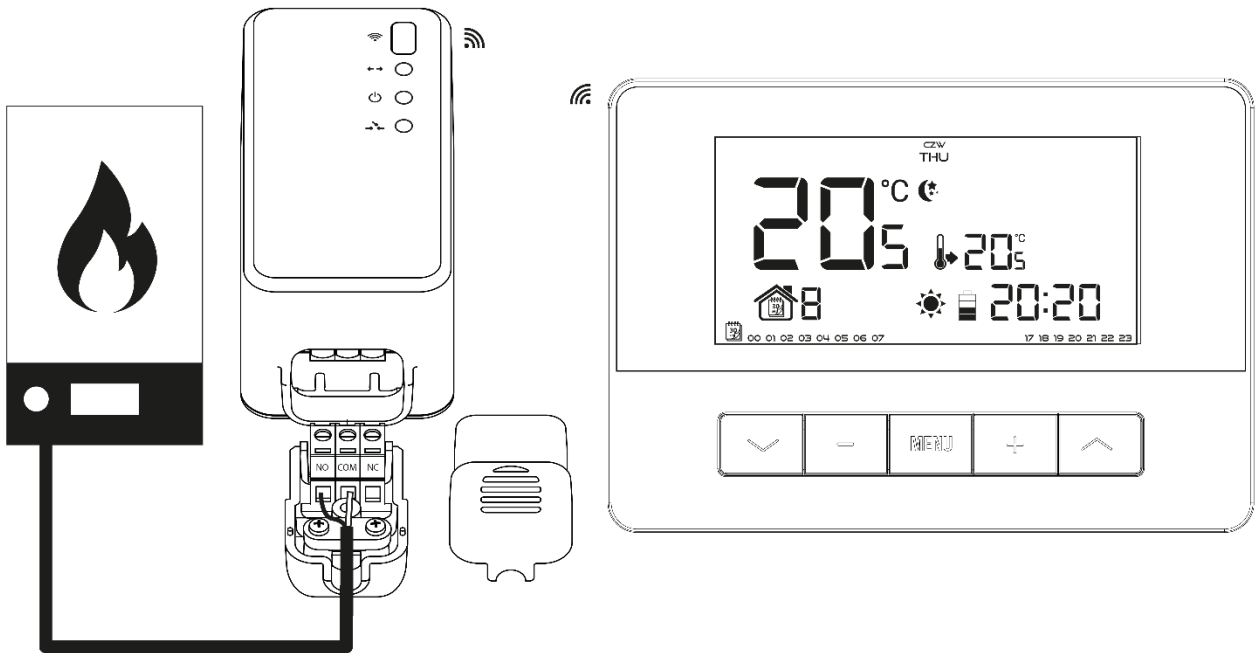

IV. EU-MW-3 RECEIVER

The EU-T-4.2N regulator communicates with the heating device (or the CH boiler controller) by means of a radio signal sent to the EU-MW-3 receiver. Such a receiver is connected to the heating device (or the CH boiler controller) by means of a two-core cable, and communicates with the room regulator using a radio signal.

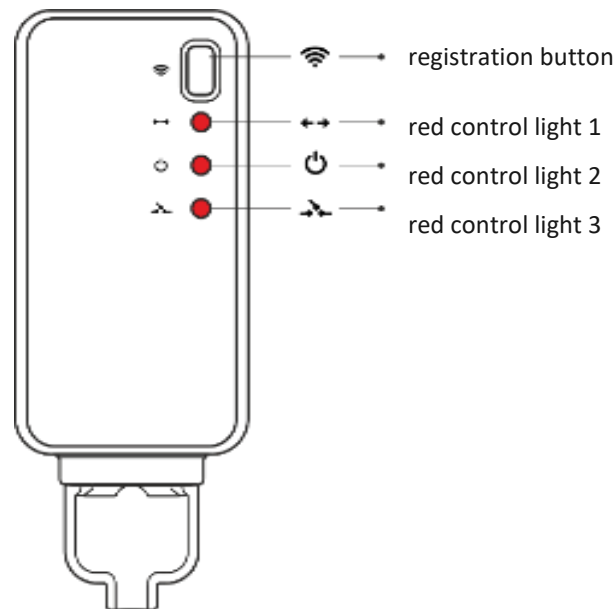

The receiver has three control lights:

- red control light 1 – it signalises data reception;
- red control light 2 – indicates receiver operation;
- red control light 3 – goes on when the room temperature fails to reach the pre-set value – the heating device is switched on

NOTE

In case of no communication (e.g. due to discharged battery), the receiver automatically disables the heating device after 15 minutes.

Registration of the EU-MW-3 receiver:

1. Press the registration button on the EU-MW-3 receiver.
2. In order to register the relays, select the "Reg" function in the Menu of the regulator and hold the Menu button or press one of the buttons ∇ \wedge . The message "Scs" means that the registration was successful while a registration error is signalled with the message "Err". In both cases the registration can be continued by pressing any button (except EXIT).

The number of registered relays is displayed on the screen. If the regulator has 6 registered relays (maximum number), it is possible to unregister them and the "Del" message is displayed. Using one of the buttons ∇ \wedge select the appropriate option "yes" or "no" depending on whether you want to unregister the relay or not.

V. FIRST START-UP

In order for the regulator to operate correctly, follow these steps when starting the device for the first time:

1. Insert the batteries - in order to do it, remove the back cover.
2. Connect the two-core cable to appropriate sockets in the regulator or the receiver.

VI. HOW TO USE THE REGULATOR

1. PRINCIPLE OF OPERATION

The EU-T-4.1N/EU-T-4.2N room regulator is designed to maintain the pre-set room temperature by sending a signal to the heating device (contact opening) when the pre-set room temperature has been reached. After receiving such a signal, the heating device is disabled (if it is connected to a CH boiler controller, the CH boiler switches to sustain mode after receiving the signal).

2. OPERATION MODES

The room regulator may operate in one of the following operation modes:

- **Day/night mode**

In this mode the pre-set temperature value depends on the current time of the day. The user may set different temperature values for the daytime and nighttime (comfort temperature and economical temperature) as well as define the exact time of entering day mode and night mode.

In order to activate this mode, press one of the buttons ∇ \wedge until *day/night mode* icon appears on the main screen.

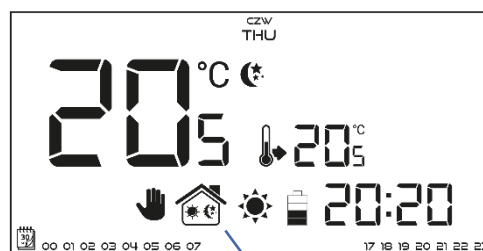

Day/night mode icon

USER MANUAL

Weekly control

This mode enables the user to define the time when the pre-set comfort temperature and the pre-set economical temperature will apply. The user may set 9 different programs divided into three groups:

- **PROGRAMS 1÷3** – daily temperature values are set for all days of the week;
- **PROGRAMS 4÷6** – daily temperature values are set separately for the weekdays (Monday-Friday) and for the weekend (Saturday-Sunday);
- **PROGRAMS 7÷9** – daily temperature values are set for each day of the week separately.

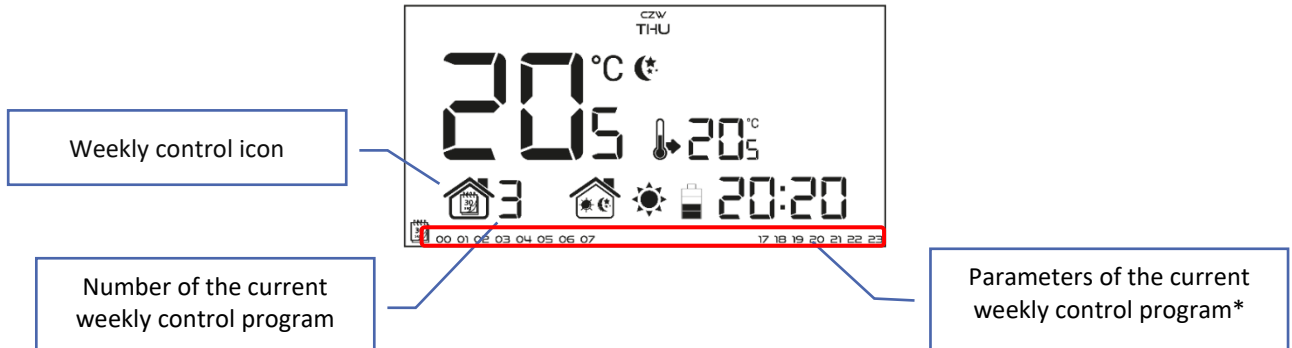

* The display shows the hours when the comfort temperature applies. In the remaining time period economical temperature applies.

In order to activate this mode, press one of the buttons \checkmark \wedge until a weekly control icon appears on the main screen.

- **Manual mode**

In this mode the pre-set temperature is adjusted manually from the main screen view with the use of plus/minus buttons (+ -). Manual mode is activated automatically when one of these buttons is pressed. Once the manual mode is activated, the previous operation mode enters *sleep mode* until the next pre-programmed temperature change. Manual mode may be deactivated by pressing one of these buttons: \wedge \checkmark

Example 1 – manual mode activation in Day/night mode

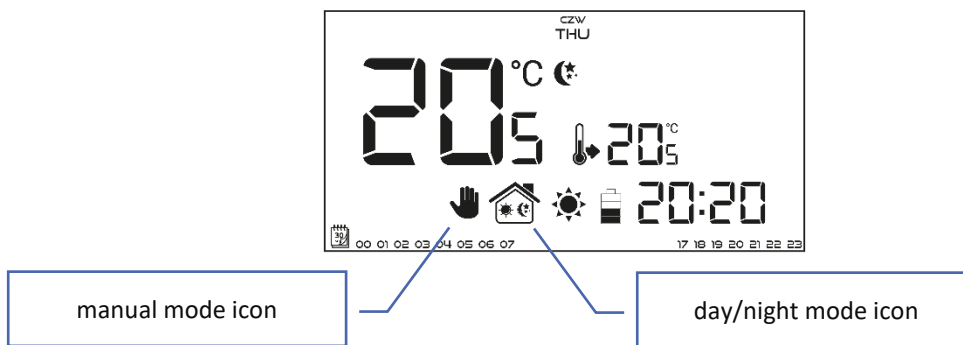

When *Day/night mode* is active, the user changes the pre-set temperature by pressing plus/minus button (+ -), which automatically activates manual mode. The controller returns to Day/night mode when daytime changes into nighttime (or the other way round) or when the user presses one of the buttons: \checkmark \wedge .

Example 2 - manual mode activation in Weekly control mode

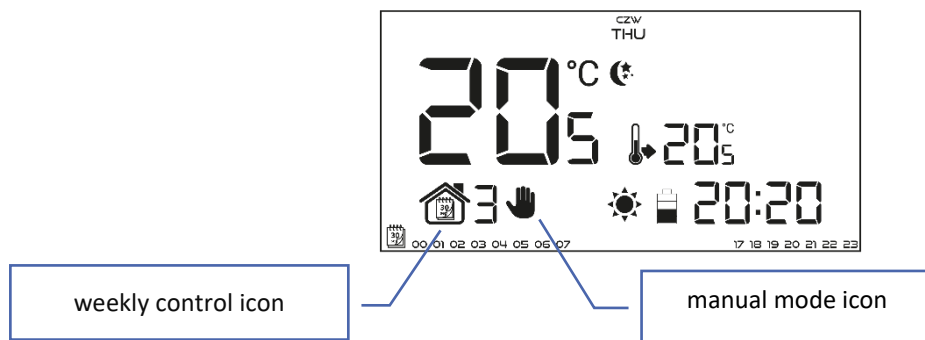

When *Weekly control mode* is active, the user changes the pre-set temperature by pressing plus/minus button (+ -), which automatically activates manual mode. The controller returns to *Weekly control mode* when, according to the weekly schedule, daytime changes into nighttime (or the other way round) or when the user presses one of the button

3. MAIN SCREEN VIEW AND DESCRIPTION



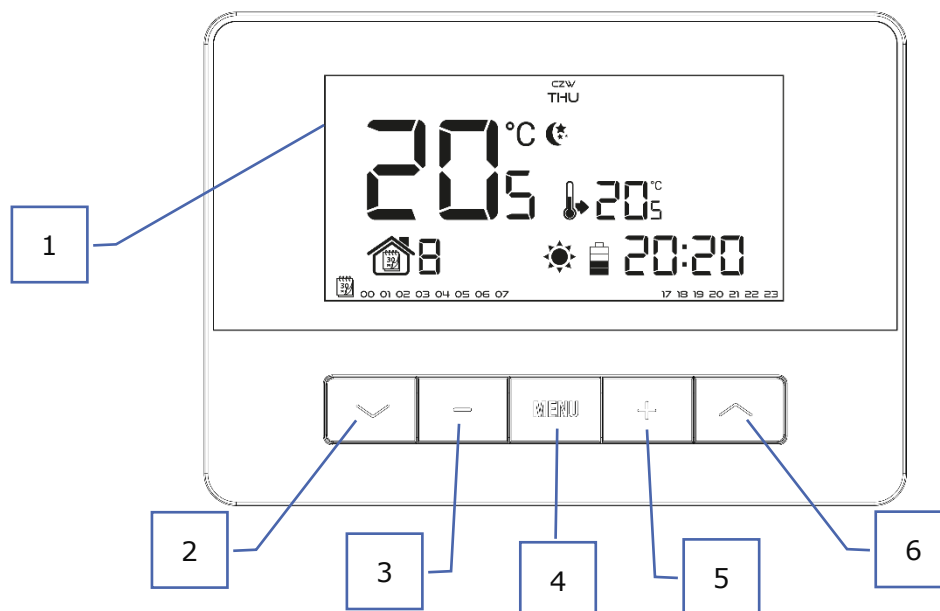



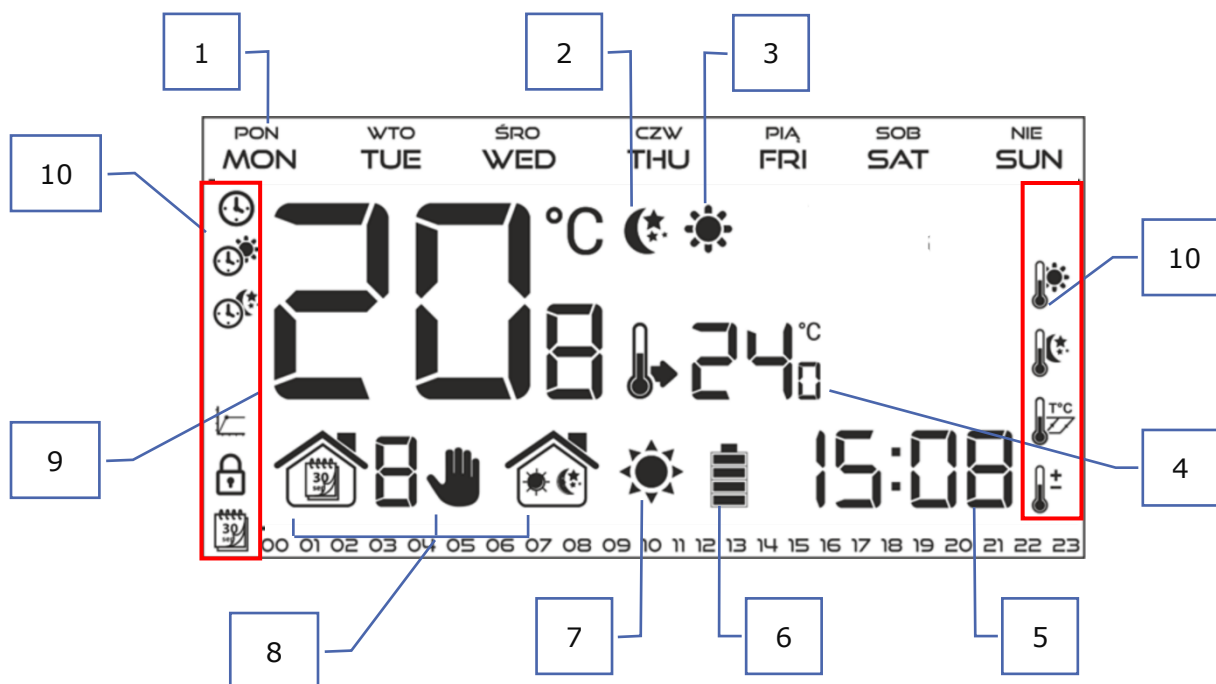



The user operates the device using buttons. While one parameter is being edited, the remaining icons are not displayed.



1. Display
2. - in the main screen view, use this button to activate weekly control mode. In the controller menu, use this button to switch between functions.
3. Minus button (-) – in the main screen view - press this button to switch to manual mode and decrease the pre-set temperature value. In the controller menu, use this button to change parameter settings, enter the service code etc.
4. MENU – hold this button to enter the controller menu. While editing parameters, press and hold this button to confirm the changes and return to the main screen view.
5. Plus button (+) – in the main screen view - press this button to switch to manual mode and increase the pre-set temperature value. In the controller menu, use this button to change parameter settings, enter the service code etc.
6. - in the main screen view, use this button to activate day/night mode. In the controller menu, use this button to switch between functions.



1. Day of the week
2. An icon informing about current economical temperature (resulting from weekly control or day/night mode settings).
3. An icon informing about current comfort temperature (resulting from weekly control or day/night mode settings).
4. Pre-set room temperature
5. Time
6. Battery level
7. An icon informing about room cooling/heating. The animation differs depending on the selected operation mode:
 - Heating mode – the icon flashes when the pre-set temperature has not been reached; it is steady when the pre-set temperature has been reached.
 - Cooling mode – the icon rotates when the temperature is above the pre-set value; it is steady when the pre-set temperature has been reached.
8. Current operation mode:
 - a. Weekly
 - b. Manual
 - c. Day/night
9. Current room temperature
10. Parameter icons (see: a table below)

Parameter icons:			
	Clock settings		Weekly control settings
	Day from...		Comfort temperature
	Night from...		Economical temperature
	Optimum start / heating/cooling mode selection (in service menu)		Hysteresis
	Service menu		Temperature sensor calibration

4. CONTROLLER FUNCTIONS

The user navigates the menu structure using all the buttons ∇ \wedge "+", "-". In order to edit particular parameters, press and hold MENU. Next, press ∇ to view the controller functions – the edited parameter is flashing whereas the remaining parameters are not displayed. Use plus and minus buttons (+ -) to change the parameter settings. Press ∇ to confirm the changes and move on to edit the next parameter or press and \wedge to confirm the changes and return to the previous parameter or press and hold MENU to confirm and return to the main screen view - apart from editing weekly control settings.

4.1. MAIN MENU

MENU	Day of the week
	Clock
	Day from...
	Night from...
	Button lock
	Optimum start
	Automatic manual mode
	Weekly program
	Pre-set comfort temperature
	Pre-set economical temperature
	Pre-set temperature hysteresis
	Temperature sensor calibration
	Registration (EU-T-4.2n)
	Service menu

4.2. DAY OF THE WEEK

After entering the main menu, all icons which are not connected with the parameter which is being edited are not displayed. The first parameter is day of the week. Press + or - until the current day of the week appears on the screen. Press ∇ to confirm and move on to the next parameter or press and hold MENU to confirm and return to the main screen view.

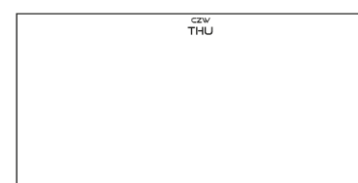

USER MANUAL

4.3. CLOCK

In order to set current time, enter the menu and press \checkmark or \wedge until time setting screen appears on the screen.

By pressing + or - set the hour and minutes. Press \checkmark to confirm.

Press \checkmark to confirm and move on to the next parameter or press and hold MENU to confirm and return to the main screen view.



4.4. DAY FROM...

This function enables the user to define the exact time of entering the day mode. When Day/night mode is active, comfort temperature applies at daytime.

To configure this parameter press \checkmark or \wedge until *Day from...* setting screen appears.

By pressing + or - set the hour and minute of day mode activation.

Press \checkmark to confirm and move on to the next parameter or press and hold MENU to confirm and return to the main screen view.



4.5. NIGHT FROM...

This function enables the user to define the exact time of entering the night mode. When Day/night mode is active, economical temperature applies at nighttime.

To configure this parameter press \checkmark or \wedge until *Night from...* setting screen appears.

By pressing + or - set the hour and minute of night mode activation.

Press \checkmark to confirm and move on to the next parameter or press and hold MENU to confirm and return to the main screen view.



4.6. BUTTON LOCK

In order to activate the button lock, press MENU until a padlock icon appears. Use one of the buttons \checkmark or \wedge to select ON. In order to unlock the buttons, press and hold the buttons \checkmark/\wedge at the same time, select the button lock function and select OFF.



4.7. OPTIMUM START

Optimum start is an intelligent system controlling the heating/cooling process. It involves constant monitoring of the heating/cooling system efficiency and using the information to activate the heating/cooling process in advance in order to reach the pre-set temperatures.

The system requires no user intervention. It precisely reacts to any changes that affect the efficiency of the heating system. If, for example, some changes have been introduced to the heating system and the house heats up faster than before, the Optimum start system will recognize the changes at the next pre-programmed temperature change (from comfort to economical) and in the next cycle the heating system activation will be adequately delayed, reducing the time needed to reach the desired temperature.

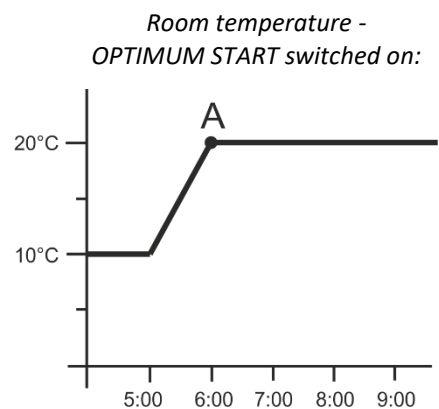
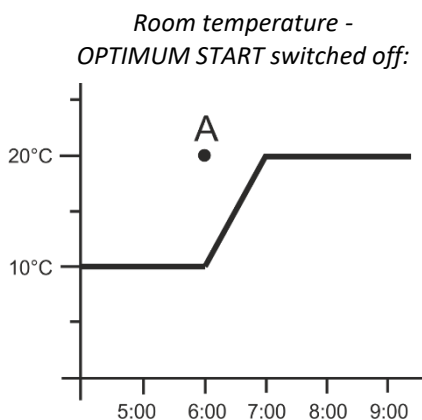

A – pre-programmed change from economical temperature to comfort temperature

Activating this function means that at the time of pre-programmed change of the pre-set temperature from comfort to economical or the other way round, the current room temperature is close to the desired value.

In order to configure this parameter, press one of the buttons ∇ / \blacktriangle until *Optimum start* setting panel appears on the screen.

Use + or - to activate or deactivate *Optimum start* function (ON/OFF). Press ∇ to confirm and move on to edit the next parameter or press and hold MENU to confirm and return to the main screen view.



4.8. AUTOMATIC MANUAL MODE

This function enables manual mode control. If this function is active (ON), the manual mode is disabled automatically when a pre-programmed change resulting from the previous operation mode is introduced. If the function is disabled (OFF), the manual mode remains active regardless of the pre-programmed changes

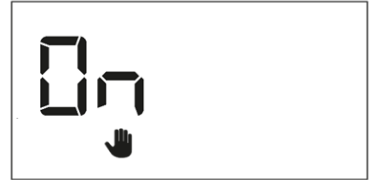

4.9. WEEKLY PROGRAM

This function is used to change the current weekly control program and edit the weekly programs.

- **How to change weekly program number**

When weekly control is enabled (see: VII.2. *Operation modes*) the current program is activated. In order to select the current program number, enter the menu and press one of the buttons ∇ or \blacktriangle until weekly program setting screen opens up.

By pressing and holding MENU button the user opens up the program selection screen. Each time the user holds the MENU button, the program number changes. When the desired number appears on the screen, press MENU – the controller returns to the main screen view and the selected program number is set.



weekly program number

- **How to configure particular weekly programs**

Weekly program allows the user to define the time when comfort temperature and economical temperature will apply. Depending on the program number, the user may set daily temperature values for all days of the week (programs 1÷3), for weekdays and the weekend separately (programs 4÷6) and for each day of the week separately (programs 7÷9).

In order to select the current program number, enter the menu and press one of the buttons ∇ or \blacktriangle until weekly program setting screen opens up.

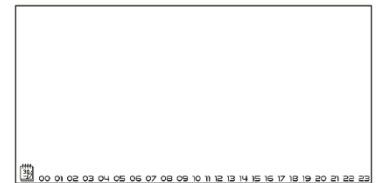

STEP 1 - CHOOSE THE PROGRAM TO BE EDITED

By pressing and holding MENU button the user opens up the program editing screen. Each time the user press the \blacktriangle button, the program number changes. When the desired number appears on the screen, the user may start editing its parameters.

weekly program number

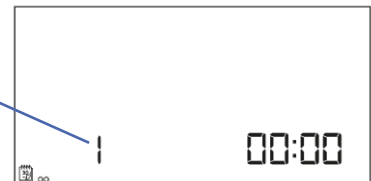

STEP 2 - SELECT DAYS OF THE WEEK

If the user wants to edit programs 1÷3, there is no possibility of selecting particular days of the week as the setting applies to each day.

If the user wants to edit programs 4÷6, it is possible to edit the settings for weekdays and the **weekend** separately. Press buttons ∇ or \blacktriangle briefly in order to select.

USER MANUAL

If the user wants to edit programs 7÷9, it is possible to edit the settings for each day separately. Press buttons \checkmark or \wedge briefly in order to select a day.

editing parameters for Monday



In order to choose the days when a given program should apply, use of the Menu button.

STEP 3 - ASSIGNING COMFORT OR ECONOMICAL TEMPERATURE TO PARTICULAR HOURS

An hour which is being edited is displayed on the controller screen. In order to assign comfort temperature, press the plus button (+). In order to select economical temperature, press the minus button (-).

The parameters of the weekly program are displayed at the bottom of the screen: **hours to which comfort temperature has been assigned are displayed whereas hours to which economical temperature has been assigned are not displayed.**

edited hour

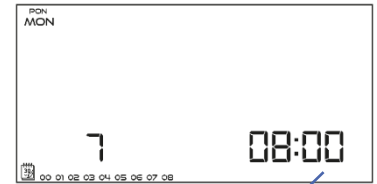

Example:

The following screenshot presents daily settings of program no. 7 for Monday

- 24⁰⁰-01⁵⁹- economical temperature
- 02⁰⁰-06⁵⁹- comfort temperature
- 07⁰⁰-14⁵⁹- economical temperature
- 15⁰⁰-21⁵⁹- comfort temperature
- 22⁰⁰-00⁵⁹- economical temperature

editing weekdays parameters

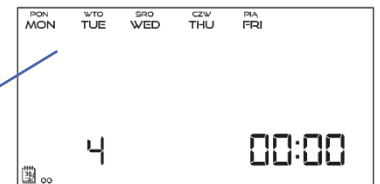

NOTE

When the user finishes the editing process by pressing MENU button, the controller returns to the main screen view and this program is selected as the current program.

4.10. PRE-SET COMFORT TEMPERATURE

Pre-set comfort temperature is used in weekly control mode and day/night mode. Press one of the buttons \checkmark \wedge until the comfort temperature change screen appears on the screen.

Press + or - to set the desired temperature.

Press \checkmark to confirm and move on to the next parameter or press and hold MENU to confirm and return to the main screen view.



4.11. PRE-SET ECONOMICAL TEMPERATURE

Pre-set economical temperature is used in weekly control mode and day/night mode. Press one of the buttons \checkmark \wedge until the economical temperature change screen appears on the screen.

Press + or - to set the desired temperature.

Press \checkmark to confirm and move on to the next parameter or press and hold MENU to confirm and return to the main screen view.



4.12. PRE-SET TEMPERATURE HYSTERESIS

Room temperature hysteresis defines the tolerance of the pre-set temperature at which cooling or heating is activated (within the range of 0,2 ÷ 4°).

In order to set the hysteresis, press one of the buttons \checkmark \wedge until the hysteresis settings appear on the screen.



Use + or - to set the desired hysteresis value. Press \checkmark to confirm and move on to the next parameter or press and hold MENU to confirm and return to the main screen view.

Example:

Pre-set temperature : 23°C

Hysteresis : 1°C

The room regulator reports that the temperature is too low only when the room temperature drops to 22 °C.

4.13. TEMPERATURE SENSOR CALIBRATION

It is performed when mounting the regulator or after it has been used for a long time, if the room temperature measured by the internal sensor differs from the actual temperature. Calibration setting range is from -10°C to +10°C with the accuracy of 0,1°C.

Press one of the buttons \checkmark / \wedge until the sensor calibration panel appears on the screen. Use + and – to define correction. Press \checkmark to confirm and move on to edit the next parameter or press and hold MENU to confirm and return to the main screen view.

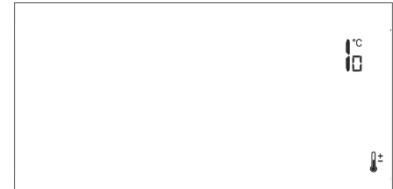

4.14. REGISTRATION

The description of the functions can be found in chapter IV. Wireless controller receiver.

4.15. SERVICE MENU



Certain functions in the controller service menu are secured with a code. In order to adjust their parameters, one of the buttons \checkmark / \wedge until *Service menu* settings appear on the screen.

To view the service menu it is necessary to enter the code – 215. Use + or – to select the first digit (2) and press MENU to confirm. Follow the same steps selecting the remaining two digits. Press the button \wedge to confirm the code.



- **Heating HEAT/cooling COOL mode**

This function enables the user to select the room regulator operation mode:

-  COOL - controlling the cooling system
-  HEAT - controlling the heating system

Press + or - to select desired type of system. Press buttons \checkmark / \wedge to confirm and move on to edit another parameter in the service menu or press MENU button to confirm to return to the main screen view.

- **How to edit the minimum (T1) and maximum (T2) pre-set temperature**

This function enables the user to set the minimum (T1) and the maximum (T2) pre-set room temperature. Select this option - the parameter starts flashing. Use the buttons +/- to set the temperature. To confirm, press the MENU button (confirm and go on to edit the next parameter) or press EXIT to confirm and return to the main screen view.

- **Optimum Start calibration**

Optimum start calibration starts when the controller detects the heating need in order to reach the pre-set temperature, with the Optimum start function turned on.

- **DEF factory settings**

This function enables the user to restore factory settings. In order to do it, select *Def* function and press MENU to confirm. Next, use the buttons +/- to select YES and conform by pressing MENU.

VII. TECHNICAL DATA

	EU-T-4.1N	EU-T-4.2N
Power supply	2xAA, 1,5V batteries	2xAA, 1,5V batteries
Room temp. adjustment range	5°C ÷ 35°C	5°C ÷ 35°C
Potential-free cont. nom. out. load	230V AC / 0,5A (AC1) * 24V DC / 0,5A (DC1) **	-
Measurement error	± 0,5	± 0,5
Operation frequency	-	868MHz

	EU-MW-3 (EU-T-4.2N)
Power supply	230V ± 10% / 50Hz
Operation temperature	5°C ÷ 50°C
Maximum power consumption	<1W
Potential-free cont. nom. out. load	230V AC / 0,5A (AC1) * 24V DC / 0,5A (DC1) **
Operation frequency	868MHz
Max. transmission power	25mW

* AC1 load category: single-phase, resistive or slightly inductive AC load.

** DC1 load category: direct current, resistive or slightly inductive load.

TECH CONTROLLERS

EU declaration of conformity

Hereby, we declare under our sole responsibility that **EU-T-4.1N** manufactured by TECH STEROWNIKI II Sp. z o.o., headquartered in Wieprz Biała Droga 31, 34-122 Wieprz, is compliant with Directive **2014/35/EU** of the European Parliament and of the Council of 26 February 2014 on the harmonisation of the laws of Member States relating to **the making available on the market of electrical equipment designed for use within certain voltage limits** (EU OJ L 96, of 29.03.2014, p. 357), **Directive 2014/30/EU** of the European Parliament and of the Council of 26 February 2014 on the harmonisation of the laws of Member States relating to **electromagnetic compatibility** (EU OJ L 96 of 29.03.2014, p.79), Directive **2009/125/EC** establishing a framework for the setting of ecodesign requirements for energy-related products as well as the regulation by the MINISTRY OF ENTREPRENEURSHIP AND TECHNOLOGY of 24 June 2019 amending the regulation concerning the essential requirements as regards the restriction of the use of certain hazardous substances in electrical and electronic equipment, implementing provisions of Directive (EU) 2017/2102 of the European Parliament and of the Council of 15 November 2017 amending Directive 2011/65/EU on the restriction of the use of certain hazardous substances in electrical and electronic equipment (OJ L 305, 21.11.2017, p. 8).

For compliance assessment, harmonized standards were used:

PN-EN IEC 60730-2-9:2019-06, PN-EN 60730-1:2016-10, EN IEC 63000:2018 RoHS.

UE declaration of conformity

Hereby, we declare under our sole responsibility that **EU-T-4.2N** manufactured by TECH STEROWNIKI II Sp. z o.o., headquartered in Wieprz Biała Droga 31, 34-122 Wieprz, is compliant with Directive **2014/53/EU** of the European parliament and of the Council of 16 April 2014 on the harmonisation of the laws of the Member States relating to the making available on the market of radio equipment, Directive **2009/125/EC** establishing a framework for the setting of ecodesign requirements for energy-related products as well as the regulation by the MINISTRY OF ENTREPRENEURSHIP AND TECHNOLOGY of 24 June 2019 amending the regulation concerning the essential requirements as regards the restriction of the use of certain hazardous substances in electrical and electronic equipment, implementing provisions of Directive (EU) 2017/2102 of the European Parliament and of the Council of 15 November 2017 amending Directive 2011/65/EU on the restriction of the use of certain hazardous substances in electrical and electronic equipment (OJ L 305, 21.11.2017, p. 8).

For compliance assessment, harmonized standards were used:

PN-EN IEC 60730-2-9 :2019-06 art. 3.1a Safety of use

PN-EN 62479:2011 art. 3.1 a Safety of use

ETSI EN 301 489-1 V2.2.3 (2019-11) art.3.1b Electromagnetic compatibility

ETSI EN 301 489-3 V2.1.1:2019-03 art.3.1 b Electromagnetic compatibility

ETSI EN 300 220-2 V3.2.1 (2018-06) art.3.2 Effective and coherent use of radio spectrum

ETSI EN 300 220-1 V3.1.1 (2017-02) art.3.2 Effective and coherent use of radio spectrum

EN IEC 63000:2018 RoHS.

Wieprz, 22.08.2023

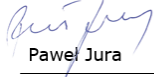
Paweł Jura

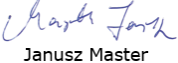
Janusz Master

Prezisi firmy

**TECH
TECH
CONTROLLERS**

Central headquarters:

ul. Biała Droga 31, 34-122 Wieprz

Service:

ul. Skotnica 120, 32-652 Bulowice

phone: **+48 33 875 93 80**

e-mail: **serwis@techsterowniki.pl**

www.tech-controllers.com