

TECH CONTROLLERS

USER MANUAL EU-480

EN

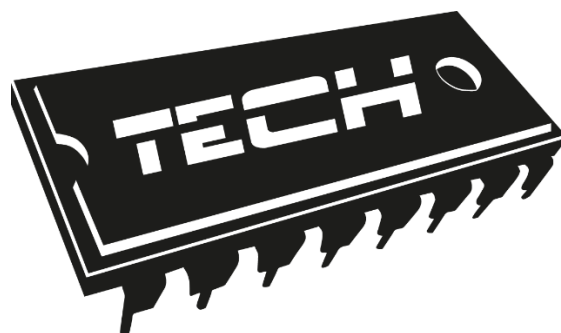



EU DECLARATION OF CONFORMITY

Hereby, we declare under our sole responsibility that **EU-480** manufactured by TECH, headquartered in Wieprz Biała Droga 31, 34-122 Wieprz, is compliant with Directive **2014/35/EU** of the European Parliament and of the Council of 26 February 2014 on the harmonisation of the laws of Member States relating to **the making available on the market of electrical equipment designed for use within certain voltage limits** (EU OJ L 96, of 29.03.2014, p. 357), Directive **2014/30/EU** of the European Parliament and of the Council of 26 February 2014 on the harmonisation of the laws of Member States relating to **electromagnetic compatibility** (EU OJ L 96 of 29.03.2014, p.79), Directive **2009/125/EC** establishing a framework for the setting of ecodesign requirements for energy-related products as well as the regulation by the MINISTRY OF ENTREPRENEURSHIP AND TECHNOLOGY of 24 June 2019 amending the regulation concerning the essential requirements as regards the restriction of the use of certain hazardous substances in electrical and electronic equipment, implementing provisions of Directive (EU) 2017/2102 of the European Parliament and of the Council of 15 November 2017 amending Directive 2011/65/EU on the restriction of the use of certain hazardous substances in electrical and electronic equipment (OJ L 305, 21.11.2017, p. 8).

For compliance assessment, harmonized standards were used:

PN-EN IEC 60730-2-9:2019-06, PN-EN 60730-1:2016-10.

PAWEŁ JURA

JANUSZ MASTER

WŁAŚCICIELE TECH SPÓŁKA Z OGRANICZONĄ ODPOWIEDZIALNOŚCIĄ SP. K.

Wieprz, **05.08.2021**

I. Safety

Before using the device for the first time the user should read the following regulations carefully. Not obeying the rules included in this manual may lead to personal injuries or controller damage. The user's manual should be stored in a safe place for further reference. In order to avoid accidents and errors it should be ensured that every person using the device has familiarized themselves with the principle of operation as well as security functions of the controller. If the device is to be sold or put in a different place, make sure that the user's manual is there with the device so that any potential user has access to essential information about the device.

The manufacturer does not accept responsibility for any injuries or damage resulting from negligence; therefore, users are obliged to take the necessary safety measures listed in this manual to protect their lives and property.

WARNING

- **High voltage!** Make sure the regulator is disconnected from the mains before performing any activities involving the power supply (plugging cables, installing the device etc.)
- The device should be installed by a qualified electrician.
- Before starting the controller, the user should measure earthing resistance of the electric motors as well as the insulation resistance of the cables.
- The regulator should not be operated by children.

WARNING

- The device may be damaged if struck by a lightning. Make sure the plug is disconnected from the power supply during storm.
- Any use other than specified by the manufacturer is forbidden.
- Before and during the heating season, the controller should be checked for condition of its cables. The user should also check if the controller is properly mounted and clean it if dusty or dirty.



Care for the natural environment is our priority. Being aware of the fact that we manufacture electronic devices obligates us to dispose of used elements and electronic equipment in a manner which is safe for nature. As a result, the company has received a registry number assigned by the Main Inspector of Environmental Protection. The symbol of a crossed out rubbish bin on a product means that the product must not be thrown out to ordinary waste bins. By segregating waste intended for recycling, we help protect the natural environment. It is the user's responsibility to transfer waste electrical and electronic equipment to the selected collection point for recycling of waste generated from electronic and electrical equipment.

II. Description

EU-480 temperature controller is intended for use with central heating boilers equipped with feeding screw. It controls water circulation pump, domestic hot water pump, floor heating pump, circulation pump, blower (fan) and fuel feeder. It incorporates a valve control module and can operate with two mixing valves (via additional ST-61 modules), conventional (two-state) room controller or RS-port communication, GSM module or Ethernet module.

The advantage of the controller is the ease of use. The user can change all parameters using the **pulser knob**. Another advantage is the large and easy-to-read display where the current boiler operation parameters are shown.

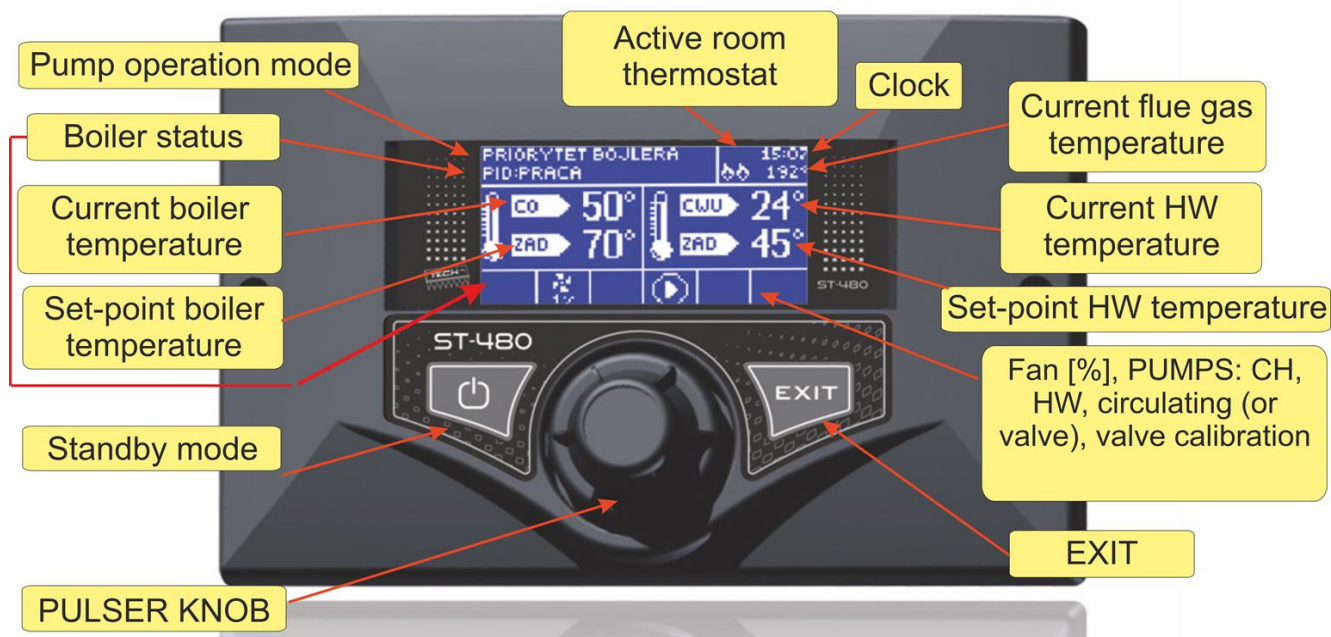

Exemplary view of the main screen:

Any remarks regarding the programme should be reported to the boiler manufacturer. Each driver should be adjusted according to individual needs depending on the fuel type used and the boiler type. TECH shall not be held liable for wrong adjustment of the controller.

II.1. Basic terms

Operation– once activated the controllers enters the *operation mode* and a "WORKING" message appears on the display. It is the basic state of the controller where the blower is operating continuously and the feeder operation time is set by the user (both operation time and pause time can be set).

Sustain mode– the mode is entered automatically if the temperature is higher than or equal to the preset temperature. In such a case the controller feeds the fuel slowly to reduce the temperature smoothly and a "SUSTAIN" message appears on the display. Both pause time and operation time in sustain mode have to be configured for the temperature to be reduced properly.

III. Functions of the controller

This chapter describes the controller functions, methods of changing the settings and use of the menu with the **pulser** (knob). The main controller screen displays boiler operating parameters. Operation mode and a number of other settings can be selected by the user according to the individual needs.

III.1. Main page

Main page is displayed on the **graphic** display during normal operation of the controller. Other main screens are displayed according the operation mode.

Once the **pulser knob** is pressed the first level menu appears. The display shows three initial menu options. Further options are available after turning the knob. An option can be selected by pressing the knob. Similar procedure is followed when changing the parameters. In order for the changes to be input they need to be confirmed by pressing the pulser after the "**CONFIRM**" message appears. If the user does not intend to make any changes in a function the pulser should be pressed after the "**CANCEL**" message is displayed. Select "**EXIT**" in the menu or use **EXIT** button to exit the menu.

Stand-by mode button located on the controller housing allows disabling all operating units quickly, if necessary. It serves as an additional emergency protection to cut-off power supply to all operating units of the controller (feeder, fan, pumps).

ATTENTION: Power supply to the controller is not cut-off in the stand-by mode.

III.2. Screen view

The user can select one of three main screens of the temperature controller operation using that function. They include:

- central heating screen (displays current boiler operation mode)
- valve (displays working parameters of the valve)
- valve 1 (displays working parameters of the first valve).
- valve 2 (displays working parameters of the second valve).

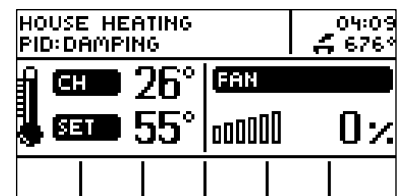

NOTE The valve parameter views are available only if the valves have been properly preinstalled and configured by a technician.

III.3. Preset temperature of the central heating system

The option is used to set the boiler temperature. The user can change the boiler temperature within the range of 45°C to 80°C. The preset central heating system temperature can also be changed directly in the main screen of the controller by turning the pulser knob.

Additionally, the preset central heating system temperature can be adjusted using the *room temperature reduction* function and the weekly control function. The preset temperature is a sum of all those values but it may not exceed the range of 45°C to 80°C.

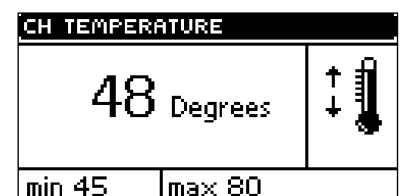

III.4. Preset temperature of hot domestic water

The option is used to set the temperature of hot domestic water. The temperature is adjustable within the range between 40°C and 75°C.

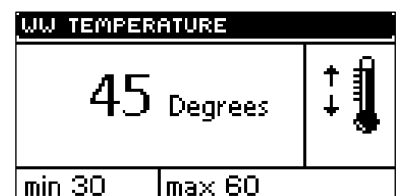

III.5. Manual operation

For your convenience the controller is equipped with a **Manual operation** module. When this function is active each actuator (blowing, central heating pump, hot water pump, additional circulating or valve pump) can be switched on or off independently and each active mixing valve can be closed, opened or stopped.

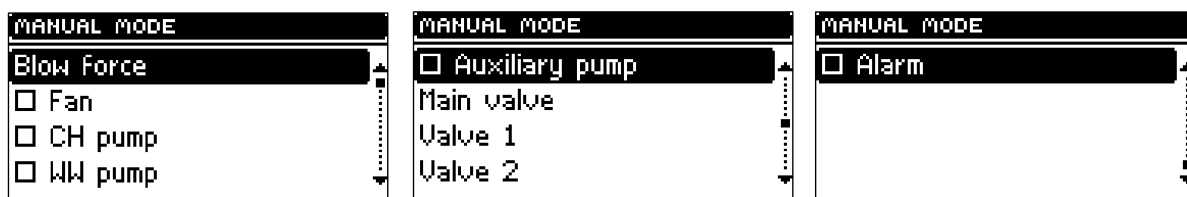

You can start the motor of your selected device by pressing the **pulsar**. The device will remain activated until the **pulsar** is pressed again.

Additionally, an option to control the *blowing power* is available where you can set any fan speed in manual mode.

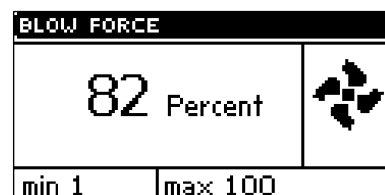

III.6. Weekly control

The function is used to programme daily changes in the boiler temperature. The preset temperature deviations are within the range of $\pm 10^{\circ}\text{C}$.

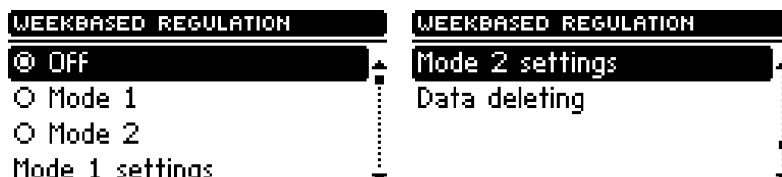

Step #1:

The user needs to set current time and date first (Installer menu > Clock).

Step #2:

The user sets temperature values for individual days of the week (Set mode 1):

Monday– Sunday

Select specific hours and required deviations from the preset temperature (how many degrees the temperature should rise or drop) for each day of the week. Additionally, the preset values can be copied to facilitate the operation.

Example

Monday

preset: 3 00 , temp. -10°C (temperature change $- 10^{\circ}\text{C}$)
 preset: 4 00 , temp. -10°C (temperature change $- 10^{\circ}\text{C}$)
 preset: 5 00 , temp. -10°C (temperature change $- 10^{\circ}\text{C}$)

In such a case, if the temperature preset on the boiler is 60°C , it will drop 10°C to 50°C between 3 a.m. and 6 a.m. on Monday.

As an alternative to the temperatures being preset separately for individual days, the temperatures can also be set collectively, in the second mode, for the working days (from Monday to Friday) and the weekend (Saturday and Sunday) separately - Set mode 2.

Monday - Friday; Saturday - Sunday

Similarly to the previous mode it is necessary to select specific times and required deviations from the temperature preset for the working days (Monday - Friday) and the weekend (Saturday, Sunday).

Example

Monday - Friday

preset: 3 00 , temp. -10°C (temperature change $- 10^{\circ}\text{C}$)
 preset: 4 00 , temp. -10°C (temperature change $- 10^{\circ}\text{C}$)

User manual

preset: 5 00 , temp. -10°C (temperature change - 10°C)

Saturday - Sunday

preset: 16 00 , temp. 5°C (temperature change +5°C)

preset: 17 00 , temp. 5°C (temperature change +5°C)

preset: 18 00 , temp. 5°C (temperature change +5°C)

In this case, if the preset boiler temperature is 60°C, the temperature will drop 10°C to 50°C between 3 a.m. and 6 a.m. on each day from Monday to Friday. However, the temperature will rise 5°C to 65°C during weekend (Saturday, Sunday) between 4 p.m. and 7 p.m.

Step #3:

The user enables one of two preset modes (Mode1, Mode2) or disables the weekly control option.

Once the mode is enabled the value of the deviation currently set is displayed on the main page of the controller next to the preset central heating system temperature. This, additionally, indicates that the weekly control is active.

Data deletion function is a simple method to remove all previously saved weekly programme settings to enter new settings.

III.7. Feeding time

This option is used to set the fuel feeder operation time. The time should be set according to the fuel being used and the boiler type.

III.8. Feeding pause

Feeding pause time is used to set the pause time in feeder operation. The pause length should be adapted to the fuel type combusted in the boiler. Wrong selection of operation and/or pause times may result in boiler malfunctioning i.e. the fuel may be not fully combusted or the boiler may not reach the preset temperature. Selection of appropriate times will ensure proper operation of the boiler

III.9. Temperature alarm

The function is activated in the **operation** mode only (i.e. when the boiler temperature is lower than the **preset temperature**). If the temperature is not rising for a period defined by the user in that function an alarm is activated: the feeder and the blower are turned off (the pump is turned on and off independently) and sound is produced. A message reading "*Central heating system temperature is not rising*" appears on the display. The alarm is cancelled by pressing the pulser knob.

III.10. Blowing rate

The function controls the fan operating speed. The adjustment range is between 1 and 100% (equivalent to fan speeds). The higher the speed is, the faster the fan operates where 1% stands for the minimum fan speed and 100% is the maximum speed.

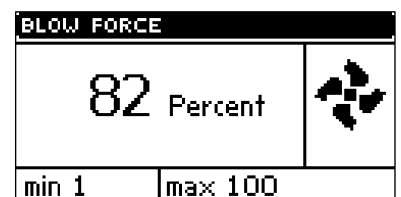

III.11. Pump operation modes

This function allows you to select one of the following four boiler operation modes:

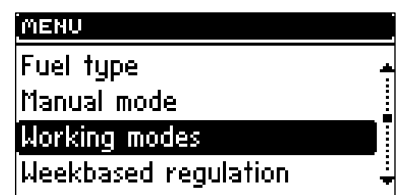

III.11.a) House heating

When you select this option the controller switches over to a mode where heating is provided only to heat the central heating circuit. The central heating pump begins to run above the pump activation temperature (factory set at 38°C - see Section III.g). The pump will turn off below this temperature (minus a hysteresis of 2°C).

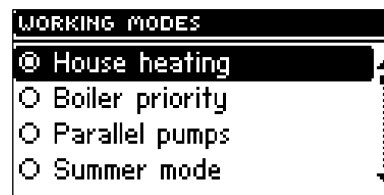

III.11.b) Boiler tank priority

In this mode, the boiler tank (hot water) pump will be switched on first to run until the set-point temperature is reached, after which the pump will be turned off and the CH circulating pump will be enabled.

The central heating pump will run all the time until the boiler tank temperature drops below its set-point by the hot water hysteresis value. At that moment the CH pump will turn off and the HW pump will turn on (both pumps operating alternately).

In this mode the fan and the feeder are run only up to 62°C as measured at the boiler (instantaneous set-point) so as to prevent overheating of the boiler.

NOTE: The boiler must be fitted with check valves on the central heating and hot water pump circuits. The valve mounted on the hot water pump is to prevent drawing hot water from the boiler tank.

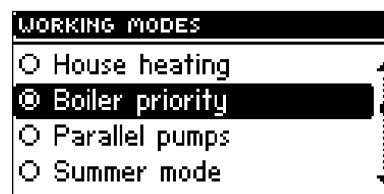

III.11.c) Pumps in parallel

In this mode both pumps begin to run together (in parallel) above the pump activation temperature. However, these temperatures may vary for each pump, depending on your settings (see Sections III.g-h). When this is so one of the pumps will switch on earlier than the other one, but after both thresholds are crossed both pumps will run together. The central heating pump will run all the time while the hot water pump will turn off when the boiler tank set-point temperature is reached. It will turn on again when the temperature drops by the preset HW hysteresis value below its set-point.

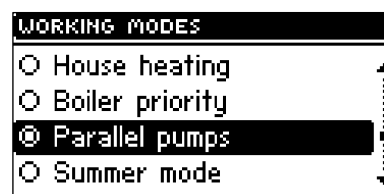

III.11.d) Summer mode

Once this function is activated the central heating pump will be off and the DHW pump will turn on above the preset activation temperature and will work continuously until the temperature drops below the activation temperature by the hot water hysteresis value or until the following conditions are met:

(boiler temperature) + 2°C ≤ (boiler tank temperature)

In summer mode you only enter the set-point temperature of the boiler, which is also understood to mean the set-point temperature of the boiler tank.

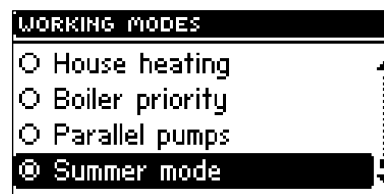

III.12. Sustained operation

This option is used to set simultaneously the feeder and blower operating time while the boiler is in the sustain mode.

III.13. Sustain pause

The sustain pause function is used to set the break time in fuel feeding in the sustain mode. Inappropriate selection of working and pause times may result in further temperature rise or unintended boiler shutdown or even lead to conditions where the fuel in the fuel tank gets fired.

III.14. Fan in sustain mode

The option allows selection of appropriate working and pause times during the fan operation in sustain mode.

III.15. Room temperature reduction

After the room controller reaches the preset temperature, the preset boiler temperature (set in the installer menu) will drop by the value set there. The reduced temperature will not be lower however than the minimum preset central heating temperature.

Example: Temperature preset on the boiler: 55°C

Room temperature reduction: 15°C

Minimum temperature set on the boiler: 45°C (factory setting)

Once the preset room temperature is reached (signalled by the room controller) the temperature preset on the boiler will drop to 45°C i.e. only by 10°C although the room temperature reduction is 15°C. At the same time a message reading "!"-10" will be shown in the main display next to the preset boiler temperature.

III.16. Factory settings

The controller is pre-configured for operation. However, it should be adapted to individual needs. Factory settings can be restored at any time. Selection of "factory settings" option will result in all boiler settings (saved in user's menu) being lost and reset to boiler manufacturer's settings.

Individual boiler parameters can be set at that point again.



ATTENTION: Restoration of factory settings will not cause the changes in service settings to be deleted.

III.17. Information about the programme

This function allows the user to check the controller programme version.



IV. Installation menu

The functions of the installation menu should be set by the person installing the boiler or service personnel of the manufacturer.

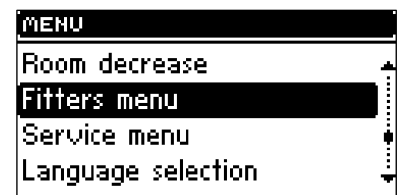

IV.1. Main valve

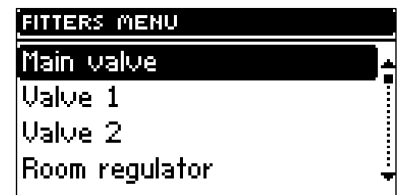

IV.1.a) Switch on

This feature allows you to temporarily make the valve inactive.

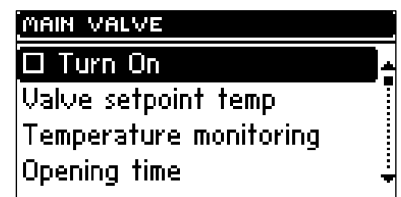

IV.1.b) Set-point valve temperature

This setting is used to set the circuit temperature to be maintained by the mixing valve. This is the main temperature based on which the *room thermostat reduction* function is to be run. The *room thermostat reduction* function is set separately for the CH system (setting in the user menu) and separately for each of the valves.

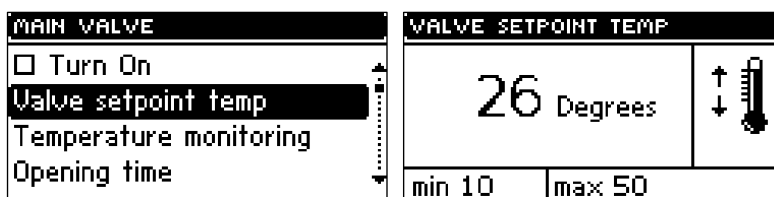

IV.1.c) Temperature control

This parameter determines the sampling (control) frequency of the water temperature downstream of the valve for the central heating or hot water system. If the sensor indicates a change in temperature (deviation from set-point), then the solenoid will open or close partially by a preset step to restore the set-point temperature.

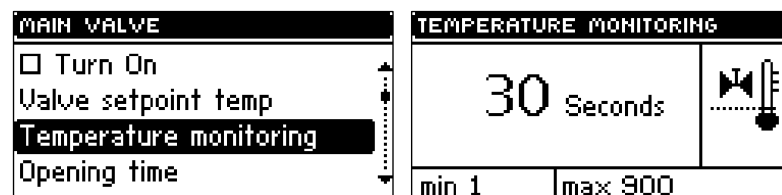

IV.1.d) Opening time

You can use this function to set the time for the full opening of the valve, that is to say, how long it takes to open the valve to 100%. This time should be selected according to your valve actuator (shown on the nameplate).



IV.1.e) Single step

You can use this function to set a percentage value for a single step in the operation of valve opening, that is to say the maximum percentage value of opening or closing that the valve can move in a single step (maximum movement of the valve in one measurement cycle).

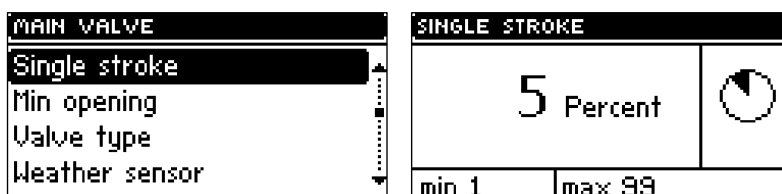

IV.1.f) Minimum opening

Use this function to set the minimum value for valve opening. Below this value, the valve will not close shut.

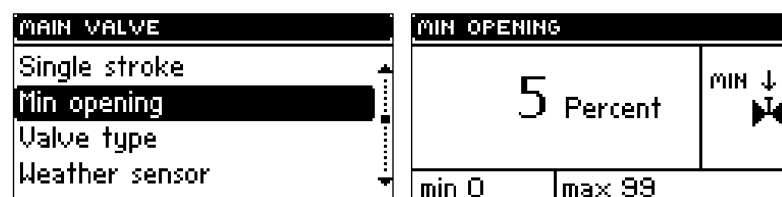

IV.1.g) Type of valve

You can use this option to select the type of valve: central heating or floor type.

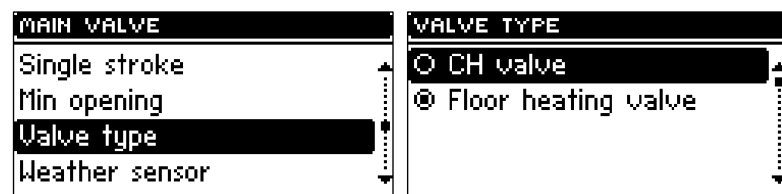

IV.1.h) Weather program (weekly valve program)

In order to enable the weather function an outdoor sensor should be installed in a place not exposed directly to sunlight or weather conditions.

After installing and connecting the sensor the Weather program function must be enabled in the controller menu.

For the valve to work properly enter set-point temperatures (downstream of the valve) for the following four intermediate outside temperatures:

- TEMP. FOR -20
- TEMP. FOR -10
- TEMP. FOR 0
- TEMP. FOR 10

Heating curve - curve which is used to determine the set-point temperature of the controller based on the outside temperature. In our controller this curve is established based on four temperature set-points selected for their respective outside temperatures. Set-point temperatures must be provided for the following outside temperatures: -20°C, -10°C, 0°C and 10°C.

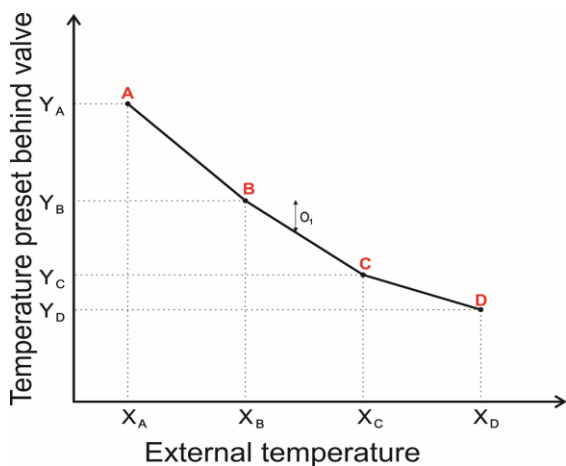

The more points there are available for constructing the curve, the greater is its accuracy, which allows you to determine its shape in a flexible way. In our case, four points seem to be a very good compromise between accuracy and ease of setting its shape.

Where in our controller:

- $X_A = -20^{\circ}\text{C}$, $X_C = 0^{\circ}\text{C}$,
- $X_B = -10^{\circ}\text{C}$, $X_D = 10^{\circ}\text{C}$,

Y_A, Y_B, Y_C, Y_D - set-point valve temperatures for their corresponding outside temperatures: X_A, X_B, X_C, X_D

After *weather control* is enabled the *valve set-point* parameter is calculated based on the heating curve. By changing this parameter you can decrease or increase all the weather control settings.

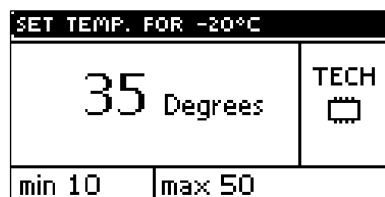
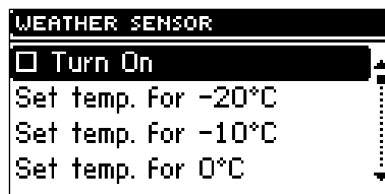
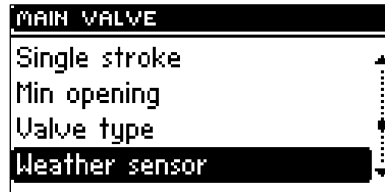

IV.1.i) Return protection

This feature allows you to enable protection for the boiler from excessively cold water returning from the main circuit, which could cause the boiler to suffer from low-temperature corrosion. The return protection function works to ensure that when the temperature is too low the valve will close partially until the short circuit of the boiler reaches the desired temperature. This feature also protects the boiler from a dangerously high return temperature to prevent water from boiling.

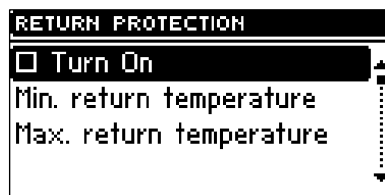
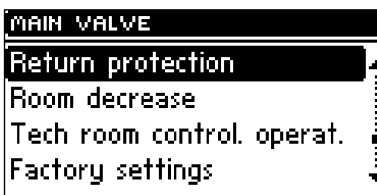

When this function is enabled you need to set the minimum and maximum return temperatures.

When this function is enabled you need to set the minimum and maximum return temperatures.

IV.1.j) Room thermostat reduction

This function is active only when the unit is operated with a (standard or TECH) room thermostat. When the room thermostat reaches the desired temperature in the house/flat (reports heated up condition), the valve will close to such an extent so that the temperature

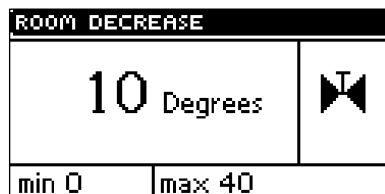
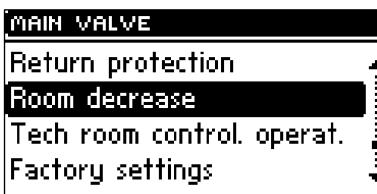

downstream of the valve drops by the <room thermostat reduction> temperature.

NOTE: If the installation includes a TECH room thermostat with RS communication (four-wire cable), you may choose an option providing dynamic control for the mixing valve.

IV.1.k) Operation of TECH thermostat

This setting is active only if the controller is connected with a TECH room thermostat (with RS communication) and allows a choice in how the thermostat is to work together with the mixing valve:

➔ **temperature reduction** - when you select this mode after heating up the house/flat to your required temperature set-point temperature the TECH room thermostat will lower the set-point temperature of the valve by the pre-set *room thermostat reduction* value (see Section II.a.10);

➔ **dynamic changes** - when you select this mode after heating up the house/flat to the set-point temperature the TECH room thermostat will work as per the following settings:

➤ **Change in valve set-point.** This setting determines by how many degrees the valve temperature is to increase or decrease with a single unit change in room temperature. This function is closely related to the *Room temperature difference* parameter.

➤ **Room temperature difference.** This setting is used to define the single unit change in the current room temperature (accurate to 0.1°C) at which there is to occur a specific change in the set-point temperature of the valve.

Example:

setting: Room temperature difference 0.5°C

setting: Change in set-point valve temperature 1°C

setting: Set-point valve temperature 40°C

setting: Set-point room thermostat temperature 23°C

Case 1. If the room temperature rises to 23.5°C (by 0.5°C) the valve will close to such an extent as to have 39°C as a set-point (by 1°C).

Case 2. If the room temperature drops to 22°C (by 1°C) the valve will open to such an extent as to have 42°C as a set-point (by 2°C).

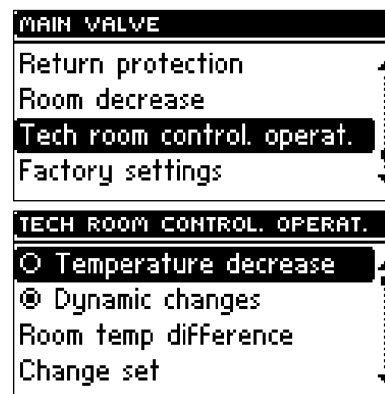

IV.1.l) Factory settings

This parameter allows you to restore the mixing valve settings saved by the manufacturer. By restoring the factory settings you will not change the valve type setting (central heating or floor type).

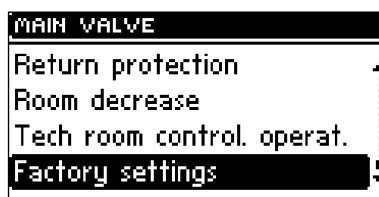

IV.2. Valve 1

NOTE: Control with an additional valve (1 or 2) is only possible after you purchase and connect the controller to an additional control module (EU-61), which is not provided as standard equipment with the controller. In order to control two valves you need to connect two EU-61 modules.

The options presented in this chapter are used to adjust the operating settings of an additional mixing valve. In order for the valve to work properly and meet your expectations it should be configured with its parameters set like in the case of the main valve.

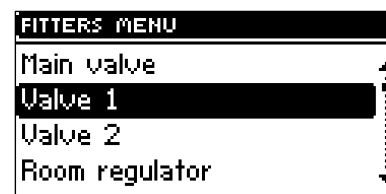

IV.2.a) Registration.

To register an additional valve enter the serial number of the control module of the EU-61 mixing valve servo (look for the five-digit number on the cover of this module). Without this number the valve cannot be activated.

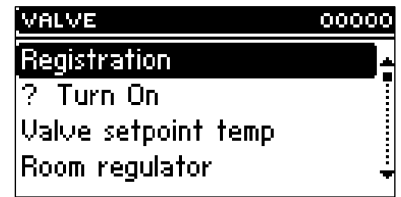

IV.2.b) Switch on

Setting as for the main valve.

IV.2.c) Set-point valve temperature

Setting as for the main valve.

IV.2.d) Room thermostat

If the valve is to be operated with a room thermostat, you should select its type:

- ➔ module controller (traditional two-state type – “from the module”),
- ➔ standard or TECH controller (traditional two-state type – “from the controller”),
- ➔ TECH algorithm controller (RS communication),
- ✓ room temperature difference (setting as for the main valve),
- ✓ set-point change (setting as for the main valve).



IV.2.e) Temperature control

Setting as for the main valve.

IV.2.f) Opening time

Setting as for the main valve.

IV.2.g) Single step

Setting as for the main valve.

IV.2.h) Minimum opening

Setting as for the main valve.

IV.2.i) Type of valve

Setting as for the main valve.

IV.2.j) Weather program

Setting as for the main valve.

IV.2.k) Return protection

Setting as for the main valve.

IV.2.l) Additional sensors

When two mixing valves are used and you select this function you will be able to select the sensors from which temperature data are to be retrieved for a valve (for return and outside temperature sensors). Temperatures can be retrieved from the sensors of the valve being set (*Own*) or as per the controller sensors (*Main controller*).

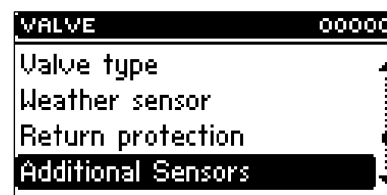
**IV.2.m) Room thermostat reduction**

Setting as for the main valve.

IV.2.n) External sensor adjustment

The external sensor is to be adjusted during installation or after prolonged use of the thermostat if the outside temperature displayed deviates from the actual one. Adjustment range: -10 to +10 °C with an accuracy of 1°C

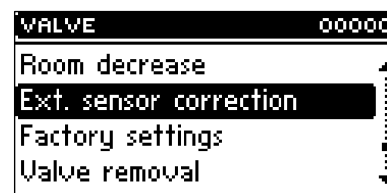
**IV.2.o) Factory settings**

Setting as for the main valve.

IV.2.p) Valve removal

This function is used to completely remove a valve from the controller memory. *Valve removal* is used for example when removing or replacing a module (the new module requires to be registered again).

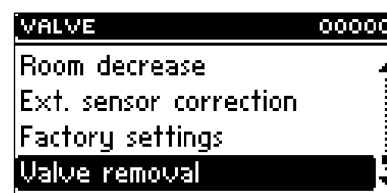
**IV.2.q) About the program**

When this option is selected the display will show the software version of the active valve module.

IV.3. Valve 2

All settings for valve 2 are made in the same way as in the case of valve 1.

**IV.4. Pump activation temperature**

The option is used to set the activation temperature for central heating and domestic hot water pumps (the temperature is measured on the boiler). None of the pumps will operate if the temperature is lower than the preset one. If the actual temperature is higher than the preset one the pumps are working but they operate depending on the operation mode (see: pump operation modes)

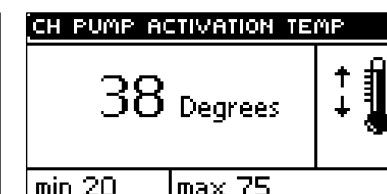
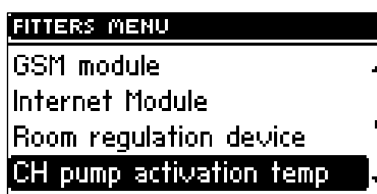

IV.5. Boiler hysteresis

This option is used to set the hysteresis of the set temperature. This is a difference between the temperature of entering the support cycle, and the temperature of return to the operation cycle (for example: when the set temperature has the value of 60°C, and the hysteresis is 3°C, switching into the support cycle will proceed when the temperature increases to 60°C, while return to the operation cycle will proceed when the temperature decreases to 57°C).

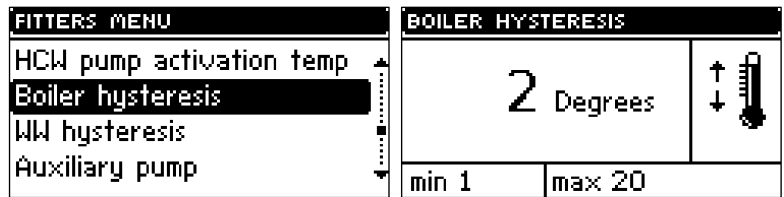

IV.6. HUW hysteresis

This option is used to set the hysteresis of the set temperature in the reboiler. It is the maximum difference between the set temperature (that is required in the reboiler) and the current temperature in the reboiler at which the HUW pump will activate. (for example: when the set temperature has the value of 55° C and the hysteresis is 5° C. After reaching the set temperature, that is 55° C, the HUW shuts down and causes activation of the CH pump. Re-activation of the HUW pump will proceed when the temperature decreases to 50° C).

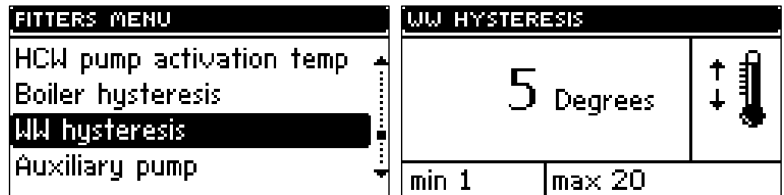

IV.7. TECH controller

A room controller can be connected to ST-480 controller. This function allows to configure the controller by selecting "ON" option. Additionally, the user may check the programme version of the room controller.

After connection of TECH controller the user may check and change the preset temperature of the central heating system, hot domestic water and the mixing valve. Additionally all boiler controller alarms are displayed. When the operation involves the mixing valve the user may preview the current external temperature while viewing the main screen with the valve parameters .

After TECH Controller option is enabled a letter "P" appears in the upper part of the display in the main screen of the controller. A flashing letter "P" indicates that the temperature in the room is too low. As soon as the required room temperature is reached the letter "P" stops flashing and stays on.

ATTENTION: No external voltage can be connected to the room controller output.

IV.8. GSM module

NOTE: *Controlling of this type is possible after purchasing and connecting, to the controller, the additional control module EU-65 which is not attached to the regulator as a standard feature.*

The GSM module is an optional device cooperating with the boiler controller, enabling remote control of the boiler operation with the use of a mobile phone. The User is notified with a text message on each alert of the boiler controller, and by sending an appropriate text message at any time, he or she receives a return message with the information on the current temperature of all sensors. After entering an authentication code it is also possible to remotely change the set temperatures.

The GSM module can also operate independently from the boiler controller. It has two inputs with temperature sensors, single contact input for use in any configuration (detecting short circuit/opening of contacts) and one controlled output (e.g. possibility to connect additional contactor to control any electrical circuit).

When any temperature sensor reaches the preset deactivation temperature, maximum or minimum, the module will automatically send a text message with such information. It is similar in the case of a short-circuit or opening of contact input, which may be used e.g. for simple protection of property.

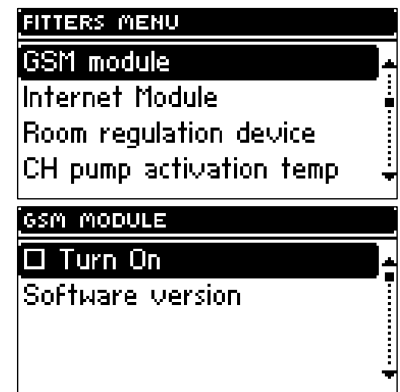

IV.9. Internet module

NOTE: Controlling of this type is possible after purchasing and connecting, to the controller, the additional control module **EU-500** which is not attached to the regulator as a standard feature.

The Internet module is a device enabling remote control of the boiler over the Internet or local network . On the home computer screen the user controls the condition of all boiler system devices and the operation of each device is presented in the animated form.

Apart from the possibility to view the temperature of every sensor, the user has the possibility of introducing changes of the set temperatures for both the pumps and the mixing valves.

After activating the Internet module and selecting the DHCP option, the controller will automatically download such parameters from the local network as: IP address, IP Mask, Gateway address and DNS Address. In the case of any problems with downloading network parameters of the existing network, there is a possibility of setting these parameters manually. The method of obtaining local network parameters has been described in the instructions for *the Internet module*.

The function *Reset module password* may be used when the User, on the login page, has changed the factory user's password to his or her password. When a new password is lost, it is possible to return to the factory password after resetting the module password.

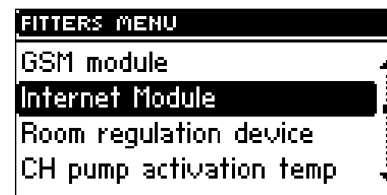

IV.10. Feeder in auto mode

The option allows enabling and disabling the automatic operation of the feeder. The feeder can be disabled to feed fuel manually or to shut the boiler down.

IV.11. Blowing in auto mode

Automatic operation of the fan can be enabled or disabled using this function. Blowing can be disabled to manually control the natural chimney draught.

IV.12. Floor pump

The function is used to control the floor heating. The user sets the floor heating temperature in the range between 30°C to 55°C. After activation of the floor pump the minimum (threshold) temperature (measured on the boiler) and the maximum (preset) temperature of the floor heating (measured on the pump sensor) should be set. The floor pump is not operating below the minimum temperature. It turns on after the minimum temperature is exceeded until the preset maximum temperature is reached. Once the preset temperature is reached the pump turns off and it is restarted if the temperature drops 2°C below the pre-set value.

IV.13. Circulation pump

The function allows to control the pump which is used to mix hot water between the boiler and the domestic hot water taps. After the function is activated the user sets the 24h activation cycle or pause cycle accurate to 30 minutes.

To facilitate the 24h operation and pause cycle setting it is possible to copy the selected time interval to another interval.

After the operation schedule has been set it is necessary to set the working and pause times for the pump while the previously selected time period is active. If necessary the previous settings can be easily deleted to facilitate setting of new intervals.

IV.14. Clock

You can use the clock settings to enter the current time and day of the week.

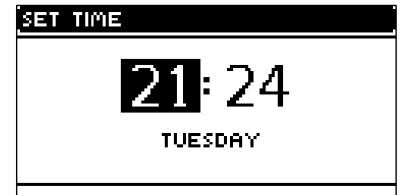
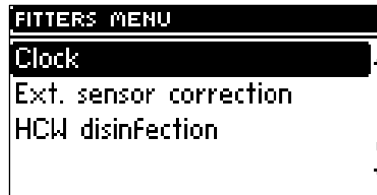

IV.15. Set the date

The function is used to set current date (day and month).

IV.16. Pulsar sensitivity

With this setting you can change the sensitivity of the pulser knob within a range from 1 to 3 (where 1 means the highest sensitivity).

IV.17. Language selection

Using this function, the user selects the language in which the controller will be operated.

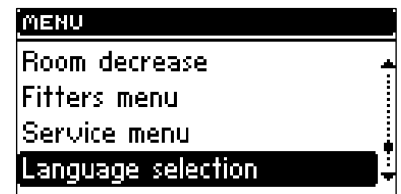

III.16 Room controller unit

This function allows to programme the operation of the room controller as follows:

- ➔ Off – the state of the room controller has no impact on other settings
- ➔ Boiler – after the room controller has indicated that the preset temperature is reached the preset boiler temperature will be reduced (detailed setting)
- ➔ Central Heating pump - after the room controller has indicated that the preset temperature is reached the central heating pump will be shut off (detailed setting)
- ➔ Room controller – the function allows to select the controller type connected to EU-480 controller to operate with the above selected unit. Two options are available:
 - two-state (standard controller)
 - TECH controller

After TECH Controller option is enabled a letter "P" appears in the upper part of the display in the main screen of the controller. A flashing letter "P" indicates that the temperature in the room is too low. As soon as the required room temperature is reached the letter "P" stops flashing and stays on

If both controllers are selected the room control temperature reduction will be active only after both controllers have sent a signal confirming that the preset room temperature has been reached.

III.17 Display contrast

Allows changing the display contrast settings.

V. Service menu

A 4-digit code has to be input to enter service functions of EU-480 controller. The code is in possession of Tech Company.

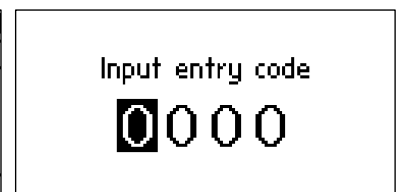

VI. Protections

To ensure maximally safe and unfailing operation, the regulator has a number of protections. In the case of an alarm, a sound signal is activated and an appropriate message is shown on the display. To make the controller return to operation, press **the pulse generator**.

VI.1. Temperature alarm

This protection is activated only in the **operation** mode (that is when the boiler temperature is lower than *the set temperature*). If the boiler temperature does not increase throughout the period set by the user, the alarm is activated, the feeder and the blow-in are deactivated (the water pump is turned on regardless of the boiler temperature) and a sound signal is activated. An appropriate message will be shown on the display.

The alarm will be disabled after pressing **the knob of the pulse generator**. The regulator returns to the recently set operation mode.

VI.2. Thermal protection

It is an additional bimetallic mini-sensor (located at the boiler temperature sensor), disconnecting the fan and the feeder in the event of exceeding the alarm temperature: 85° C. Its activation prevents the water in the installation from boiling, in the event when the boiler overheats or the controller is damaged. After activation of this protection, when the temperature goes down to a safe value, the sensor will unlock automatically and the alarm will be deactivated. In the case of damage or overheating of this sensor, the fan and feeder will be disconnected.

VI.3. Automatic sensor control

In the event of damage of each of the sensors the sound alarm is activated, additionally signalling, the defect on the relevant display, e.g.: "**CH sensor damaged**". The feeder and the blow-in is disabled. The pumps operate according to the set temperatures, regardless of alarms.

*In the case of damage of the CH sensor or the feeder, the alarm will be active until the sensor is replaced with a new one. If the HUW sensor is damaged, one should press the **menu** button, which will turn off the alarm and the controller will return to the one pump (CH) operation mode. In order to ensure that the boiler will be able to work in all modes, the sensor must be replaced with a new one.*

VI.4. Protection against boiling of water in the boiler

This protection applies only to **reboiler priority** operation mode. When the set reboiler temperature is e.g. 55° C and the actual temperature in the boiler increases up to 62° C (this is the so-called the priority temperature), then the controller will turn off and the feeder and the fan. If the temperature in the boiler still increases up to 80° C, the CH pump will be activated. When the temperature still increases, then the alarm will be activated at the temperature of 85° C. Most often such a condition may appear when the reboiler is damaged, the sensor is improperly fitted or the pump is damaged. However, when the temperature drops, then at the threshold of 60° C the controller will turn on the feeder and the blow-in and will run in the operating mode until the temperature of 62° C is reached.

VI.5. Temperature protection

The regulator has an additional protection in the event of damage of the bimetallic sensor. After exceeding the temperature of 85°C, the alarm is activated, signalling the following on the display: "**Temperature too high**". Despite damage of the bimetallic sensor, the controller receives information on the current temperature in the boiler from the electronic sensor. In the case of exceeding the alarm temperature, the fan is turned off and, at the same time, both pumps begin to operate in order to distribute hot water across the house installation.

VI.6. Fuel container protection

On the fuel feeder there is an additional temperature measuring sensor. In the event of its significant increase (above 70° C), the alarm is activated; the feeder is activated every 10 minutes, which

User manual

causes pushing the fuel to the combustion chamber. This way the feeder sensor protects against fuel ignition in the container.

VI.7. Fuse

The regulator has a WT 6.3A tubular fuse insert, protecting the network. Using a fuse with a higher value can cause damage to the existing controller.

ATTENTION: The fuse of higher value should not be used. Assembling the fuse with a higher value may cause damage to the controller.

VII. Maintenance

The **EU-480** controller must be checked for the technical condition of its wires before and during the heating season. You should also check the mounting of the controller, clean it of dust and other contamination. Furthermore, you should also measure the effectiveness of the grounding of the motors (central heating pump, hot water pump and blower).

No.	Specification	
1	Power supply	230V \pm 10% /50Hz
2	Max. power consumption	11W
3	Ambient working temperature	5÷50°C
4	Pump and valve max. output load	0,5A
5	Feeder max. output load	2A
6	Fan max. output load	0,6A
7	Temperature measurement accuracy	1°C
8	KTY sensor thermal resistance	-30÷99°C
9	Fuse	6,3A

VIII. Assembly

NOTE: Installation should be performed by a properly qualified technician! **Do not** install the unit with the power on (make sure that the plug is disconnected from the mains)!

NOTE: Incorrect wiring may damage the controller!

VIII.1. Controller wiring connection diagram

Particular attention should be paid when making cable connections with the controller. Especially, the grounding conductor should be connected properly

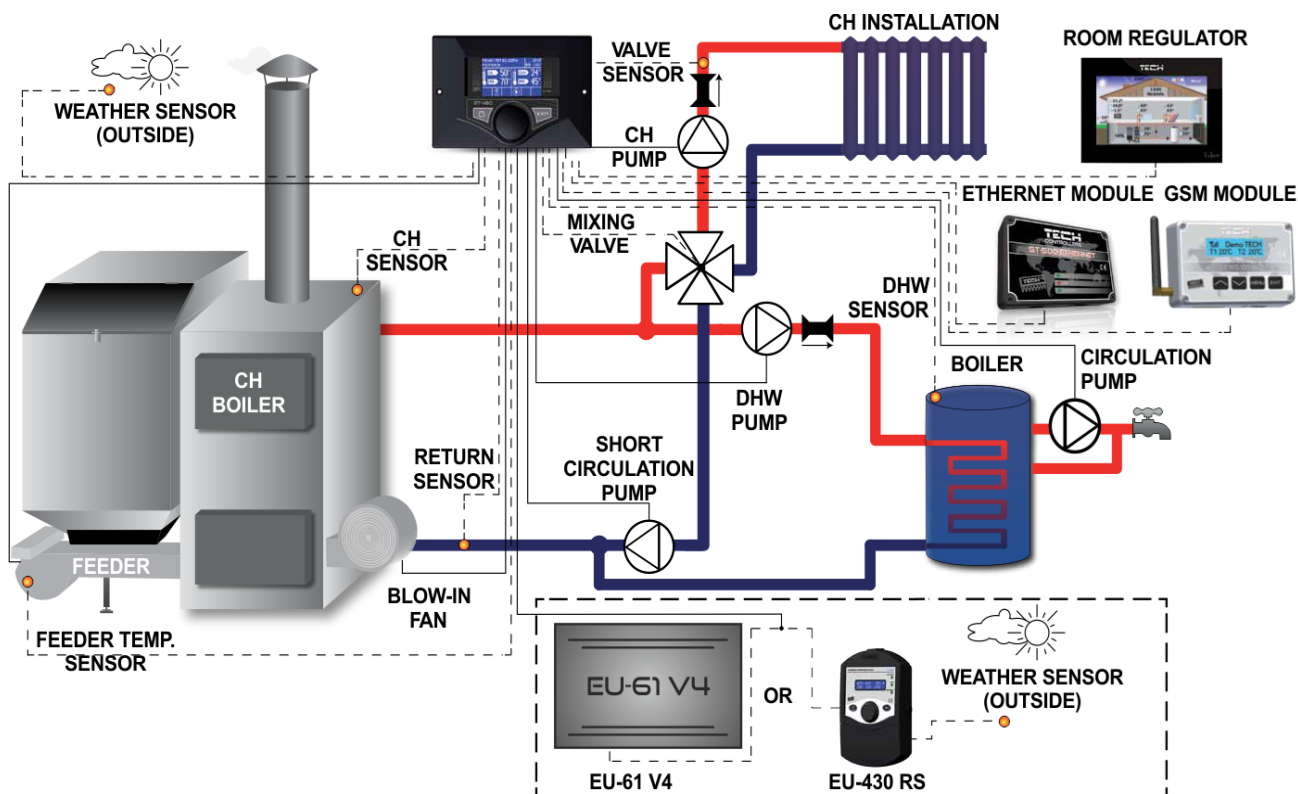

* Pictorial diagram – it cannot replace CH installation project. Its aim is to present how the controller may be expanded. This heating installation diagram does not include protective elements which are necessary to ensure correct installation

Table of contents

I.	Safety	3
II.	Description	4
II.1.	Basic terms	4
III.	Functions of the controller	4
III.1.	Main page	5
III.2.	Screen view	5
III.3.	Preset temperature of the central heating system	5
III.4.	Preset temperature of hot domestic water	5
III.5.	Manual operation	6
III.6.	Weekly control	6
III.7.	Feeding time	7
III.8.	Feeding pause	7
III.9.	Temperature alarm	7
III.10.	Blowing rate	7
III.11.	Pump operation modes	7
III.11.a)	House heating	8
III.11.b)	Boiler tank priority	8
III.11.c)	Pumps in parallel	8
III.11.d)	Summer mode	8
III.12.	Sustained operation	8
III.13.	Sustain pause	8
III.14.	Fan in sustain mode	8
III.15.	Room temperature reduction	9
III.16.	Factory settings	9
III.17.	Information about the programme	9
IV.	Installation menu	9
IV.1.	Main valve	9
IV.1.a)	Switch on	9
IV.1.b)	Set-point valve temperature	10
IV.1.c)	Temperature control	10
IV.1.d)	Opening time	10
IV.1.e)	Single step	10
IV.1.f)	Minimum opening	10
IV.1.g)	Type of valve	10
IV.1.h)	Weather program (weekly valve program)	11
IV.1.i)	Return protection	11
IV.1.j)	Room thermostat reduction	11
IV.1.k)	Operation of TECH thermostat	12

IV.1.l)	Factory settings	12
IV.2.	Valve 1	12
IV.2.a)	Registration.	13
IV.2.b)	Switch on	13
IV.2.c)	Set-point valve temperature	13
IV.2.d)	Room thermostat	13
IV.2.e)	Temperature control	13
IV.2.f)	Opening time	13
IV.2.g)	Single step	13
IV.2.h)	Minimum opening	13
IV.2.i)	Type of valve	13
IV.2.j)	Weather program	13
IV.2.k)	Return protection	13
IV.2.l)	Additional sensors	14
IV.2.m)	Room thermostat reduction	14
IV.2.n)	External sensor adjustment	14
IV.2.o)	Factory settings	14
IV.2.p)	Valve removal	14
IV.2.q)	About the program	14
IV.3.	Valve 2	14
IV.4.	Pump activation temperature	14
IV.5.	Boiler hysteresis	15
IV.6.	HUW hysteresis	15
IV.7.	TECH controller	15
IV.8.	GSM module	15
IV.9.	Internet module	16
IV.10.	Feeder in auto mode	16
IV.11.	Blowing in auto mode	16
IV.12.	Floor pump	16
IV.13.	Circulation pump	16
IV.14.	Clock	17
IV.15.	Set the date	17
IV.16.	Pulser sensitivity	17
IV.17.	Language selection	17
V.	Service menu	17
VI.	Protections	18
VI.1.	Temperature alarm	18
VI.2.	Thermal protection	18
VI.3.	Automatic sensor control	18
VI.4.	Protection against boiling of water in the boiler	18

User manual

VI.5.	Temperature protection	18
VI.6.	Fuel container protection	18
VI.7.	Fuse	19
VII.	Maintenance	19
VIII.	Assembly	19
VIII.1.	Controller wiring connection diagram	19

TECH STEROWNIKI

Spółka z ograniczoną odpowiedzialnością Sp. k.

*Biała Droga 31
34-122 Wieprz*

SERWIS

**32-652 Bulowice,
Skotnica 120**

**Tel. +48 33 8759380, +48 33 3300018
+48 33 8751920, +48 33 8704700
Fax. +48 33 8454547**

serwis@techsterowniki.pl

Monday - Friday

7:00 - 16:00

Saturday

9:00 - 12:00