

TECH CONTROLLERS

USER MANUAL EU-801 PID

EN



TABLE OF CONTENTS

1	Safety	5
2	Description of the device	6
3	How to install the controller	6
4	How to use the controller	8
4.1	Principle of operation	9
5	Controller functions – main menu	9
5.1	Fire-up/ extinguishing	10
5.2	Screen view	10
5.3	Temperature settings	10
5.3.1	Pre-set ch temperature	10
5.3.2	Pre-set dhw temperature.....	10
5.4	Operation settings*	10
5.4.1	Blow force	10
5.4.2	Fan in sustain mode	10
5.4.3	Pause in sustain mode	11
5.4.4	Fan speed in sustain mode.....	11
5.5	Manual mode	11
5.6	Pump operation modes.....	11
5.6.1	House heating	11
5.6.2	Water tank priority.....	11
5.6.3	Parallel pumps.....	11
5.6.4	Summer mode.....	12
5.7	Time settings	12
5.8	Date settings.....	12
5.9	Weekly control	12
5.10	Fitter’s menu	13
5.11	Service menu	13
5.12	Language	13
5.13	Factory settings	13
5.14	Software version.....	13
6	Controller functions – fitter’s menu	14
6.1	Valve settings	15
6.1.1	Built-in valve, valve 1,2	15
6.2	Room reg. temp. lower.....	20
6.3	GSM module.....	20
6.4	Ethernet module	21
6.5	Room regulator	22
6.5.1	CH pump control	22

6.5.2	CH boiler control	23
6.6	Operation algorithm	23
6.6.1	Standard	23
6.6.2	PID	23
6.7	Buffer parameters	24
6.7.1	Buffer	25
6.7.2	Pre-set temperature top	25
6.7.3	Pre-set temperature bottom	25
6.7.4	DHW function	25
6.8	Pump activation temperature	25
6.9	DHW hysteresis	25
6.10	Additional heat source	26
6.11	Additional pump	26
6.11.1	CH pump	26
6.11.2	CH boiler protection	26
6.11.3	Circulating pump	27
6.11.4	Short circuit pump	27
6.11.5	Valve pump	27
6.12	Pulser knob sensitivity	27
6.13	External sensor calibration	27
6.14	Water tank disinfection	27
6.15	Pump anti-stop	28
6.16	Anti-freeze temperature	28
6.17	PID supervision**	28
6.18	CH boiler hysteresis*	28
6.19	Screen settings	28
6.20	Display contrast	28
6.21	Factory settings	28
7	Protections	29
7.1	Temperature alarm	29
7.2	Thermal protection	29
7.3	Automatic sensor control	29
7.4	Protection against boiling of water in the ch boiler	29
7.5	Temperature protection	29
7.6	Fuse	30
8	Technical data	30

PS, 18.08.2021

ALL PHOTOS IN THIS DOCUMENT ARE EXAMPLES AND MAY DIFFER FROM THE ACTUAL PRODUCT.

Before using the device for the first time the user should read the following regulations carefully. Not obeying the rules included in this manual may lead to controller damage.

In order to avoid accidents and errors, it should be ensured that every person using the device has familiarized themselves with the principle of operation as well as security functions of the controller. If the device is to be put in a different place or sold, make sure that the user manual is stored with the device so that any potential user has access to essential information about the device. The manufacturer does not accept responsibility for any injuries or damage resulting from negligence; therefore, users are obliged to take the necessary safety measures listed in this manual to protect their lives and property.



WARNING

- A live electrical device! Make sure the regulator is disconnected from the mains before performing any activities involving the power supply (plugging cables, installing the device etc.)
- The device should be installed by a qualified electrician.
- Before starting the controller, the user should measure earthing resistance of the electric motors as well as the insulation resistance of the cables.
- The regulator is not intended to be operated by children.



WARNING

- The device may be damaged if struck by a lightning. During a thunderstorm, disconnect it from the power supply by taking the plug out of the power socket.
- Any use other than specified by the manufacturer is forbidden.
- Before and during the heating season, the controller should be checked for condition of its cables. The user should also check if the controller is properly mounted and clean it if dusty or dirty.

Changes in the products described in the manual may have been introduced subsequent to its completion on 18.08.2021. The manufacturer retains the right to introduce changes to the design. The illustrations may include additional equipment. Print technology may result in differences in the colours shown.



We are committed to protecting the environment. Manufacturing electronic devices imposes an obligation of providing for environmentally safe disposal of used electronic components and devices. Hence, we have been entered into a register kept by the Inspection for Environmental Protection. The crossed-out bin symbol on a product means that the product may not be disposed of to household waste containers. Recycling of waste helps to protect the environment. The user is obliged to transfer their used equipment to a collection point where all electric and electronic components will be recycled.

2 DESCRIPTION OF THE DEVICE

The EU-801 PID controller is intended for wood gasification CH boilers equipped with an exhaust fan. Due to advanced software, the controller fulfils a range of functions:

- control of fan
- control of central heating pump - CH
- control of domestic hot water pump - DHW
- control of the mixing valve actuator
- weather-based control
- weekly control
- compatible with a traditional (two-state) or RS room regulator
- possibility of connecting ST-65 GSM module and ST-505 internet module
- possibility of connecting two additional valve-controlling modules (e.g. i-1)

3 HOW TO INSTALL THE CONTROLLER

The controller should be installed by a qualified person.



WARNING

Risk of fatal electric shock from touching live connections. Before working on the controller switch off the power supply and prevent it from being accidentally switched on.



NOTE

Incorrect connection of wires may lead to controller damage.

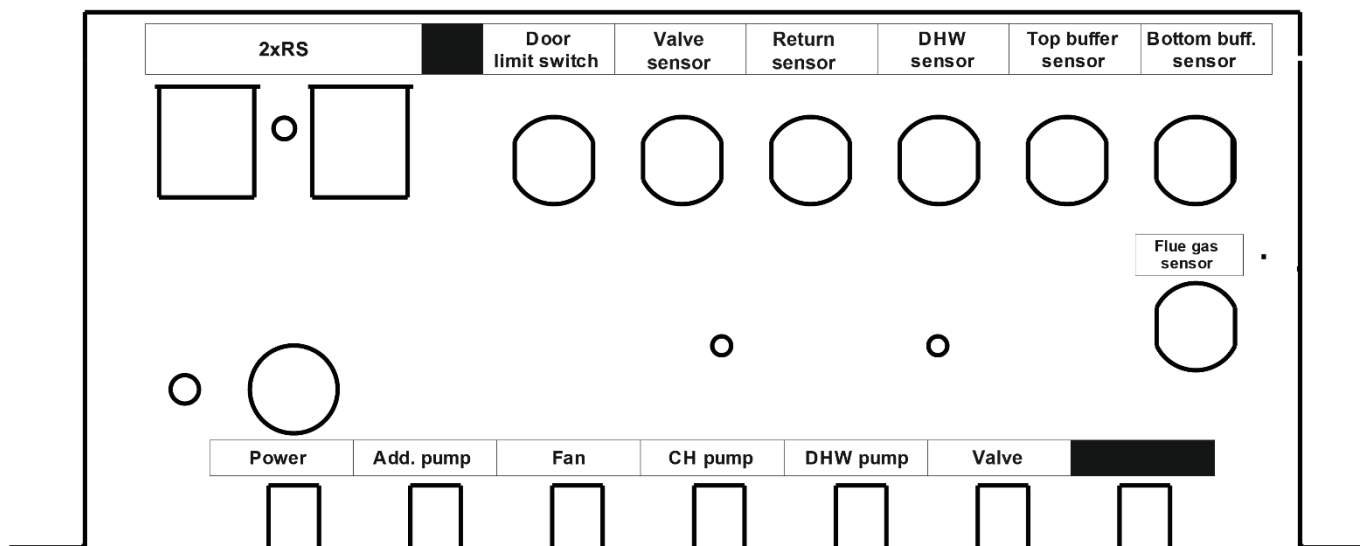

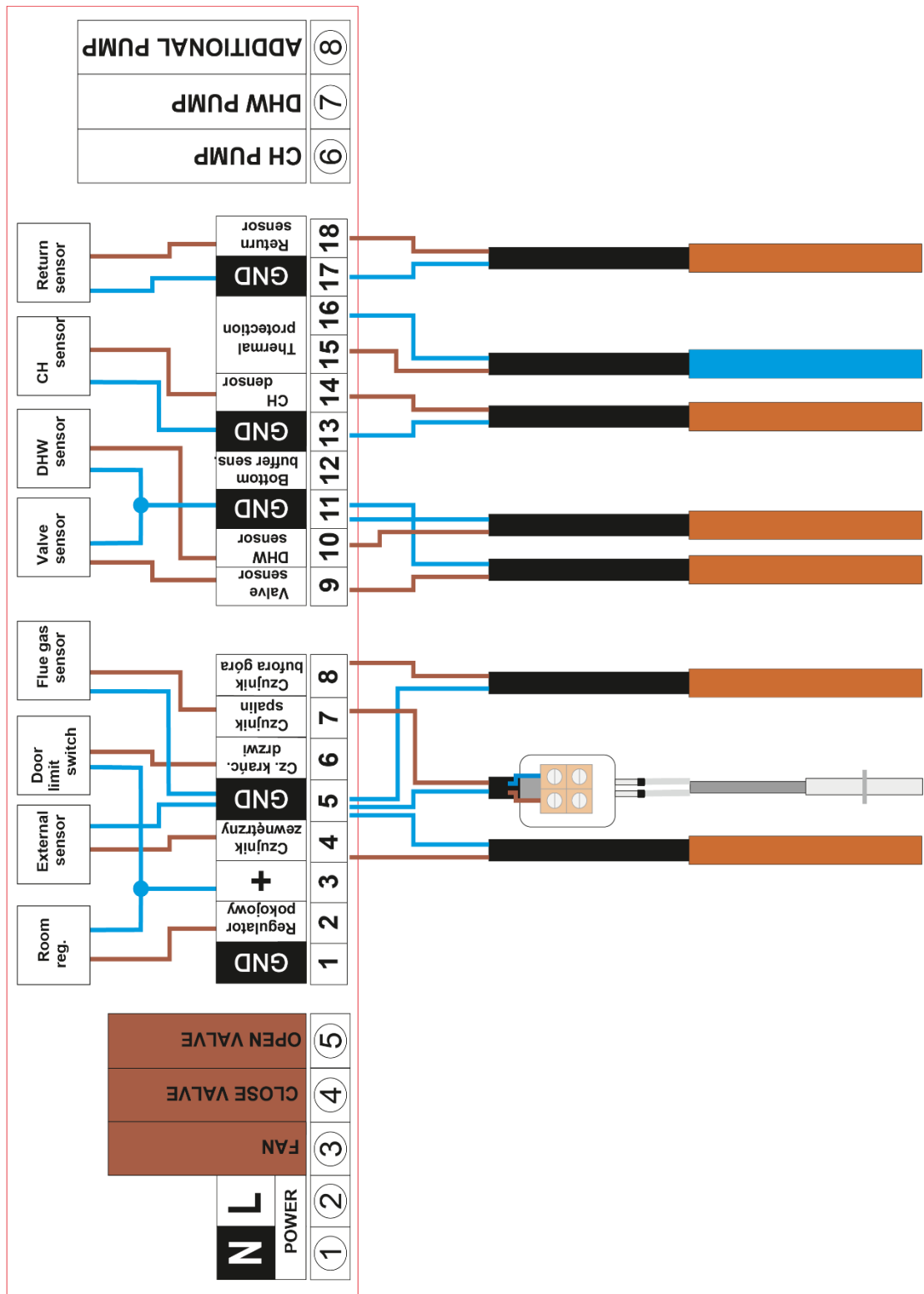

4 HOW TO USE THE CONTROLLER

During standard operation of the controller, graphic display shows the main page. Depending on the operation mode, a corresponding main screen is displayed.

By pressing **pulser knob** the user enters the first level menu. The display shows the first options of the menu. In order to move on to the next option, twist the pulser knob. Press the knob to select an option. Follow a similar procedure when adjusting parameters. In order for the changes to be saved, use the pulser knob to select **CONFIRM**. In order not to introduce any changes, use the pulser knob to select **CANCEL**. In order to exit, press **EXIT** button.

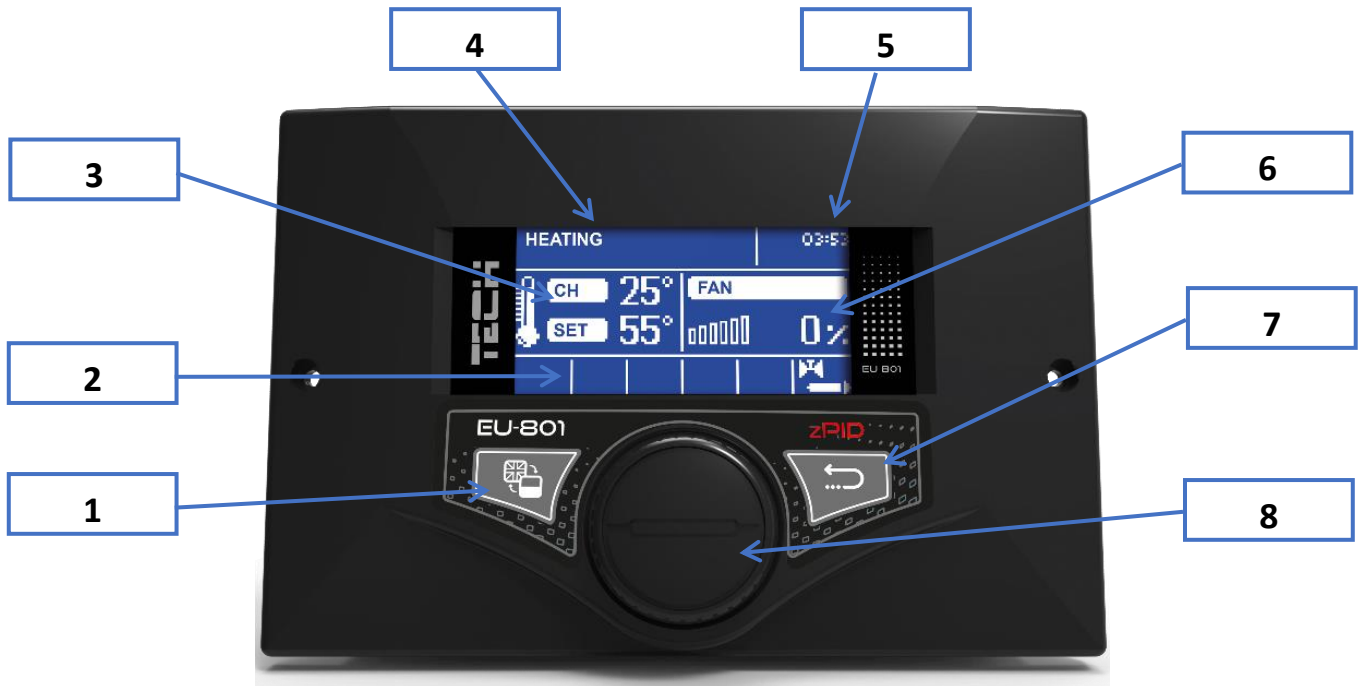

1. Language selection
2. Icons indicating active devices - e.g. fan, pump, valve
3. Left parameter panel: current CH temperature, pre-set temperature
4. Current operation mode of the controller
5. Time
6. Right parameter panel: fan speed
7. BACK button – press this button to return to the previous level
8. Pulser knob – press this button to enter the main menu and confirm new settings

The ST-801 PID temperature regulator is intended for wood gasification CH boilers. It controls water circulation pump, DHW pump and additional pump. It may also cooperate with 2 three- or four-way valves, a room regulator, GSM module and Ethernet module.



NOTE

The controller settings should be customized to suit individual user's needs, depending on the type of fuel and CH boiler used. TECH does not accept responsibility for incorrect settings.

In the event of voltage failure, the thermoregulator stops working. After the power supply has been re-established, the operation mode is restored according to the previously set parameters (owing to the built-in memory). The thermoregulator parameters remain saved even on voltage failure.

5 CONTROLLER FUNCTIONS – MAIN MENU

**MAIN
MENU**

Fire-up/ Extinguishing

Screen view

Temperature settings

Operation settings*

Manual mode

Pump operation modes

Time settings

Date settings

Weekly control

Fitter's menu

Servis menu

Language

Factory settings

Software version

* Parameter available when PID algorithm is disabled.

5.1 FIRE-UP/ EXTINGUISHING

This function enables the user to easily fire up the CH boiler. After the fire is initiated, the user activates automatic fire-up function. Owing to optimum parameters the CH boiler smoothly switches to operation mode with the use of the PID function. When the CH boiler enters the fire-up mode, this option changes to *Extinguishing*.

5.2 SCREEN VIEW

This option enables the user to select one of the following screen views:

- CH screen (current operation mode of the CH boiler is displayed)
- Built-in valve (valve parameters are displayed)
- Valve 1 (the operation parameters of valve 1 are displayed)
- Valve 2 (the operation parameters of valve 2 are displayed)
- Service screen (this screen view is not available for users; it is intended only for the device manufacturer)



NOTE

For the valve parameter screens to be available, the valves must be installed and configured by a fitter beforehand.

5.3 TEMPERATURE SETTINGS

5.3.1 PRE-SET CH TEMPERATURE

This option is used to define the pre-set CH boiler temperature. The setting range is 40°C-80°C. The pre-set temperature may also be adjusted in the main screen view by twisting the pulser knob.

5.3.2 PRE-SET DHW TEMPERATURE

This option is used to define the pre-set temperature of domestic hot water. The setting range is 35°C-60°C.

5.4 OPERATION SETTINGS*

When the PID function is disabled, the controller functions as an ordinary two-state controller and additional functions will appear in the menu.

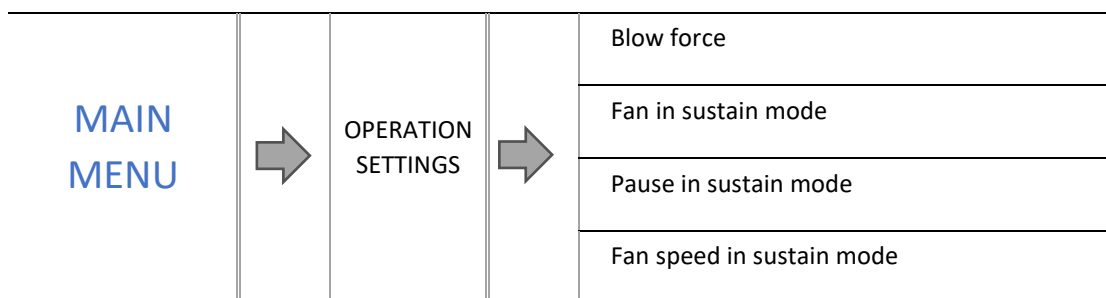

5.4.1 BLOW FORCE

This function controls the speed of the fan. The adjustment range is from 1 to 100% (it can be assumed that these are the fan's gears). The higher the gear, the faster the fan works (1% is the minimum fan speed and 100% is the maximum fan speed).

5.4.2 FAN IN SUSTAIN MODE

This option is used to configure the operation and pause time of the fan in sustain mode.

5.4.3 PAUSE IN SUSTAIN MODE

This option is used to configure the pause time of the fan in sustain mode.



NOTE

Incorrect settings may lead to constant temperature increase! Pause in sustain mode should not be too short.

5.4.4 FAN SPEED IN SUSTAIN MODE

This option is used to adjust the fan speed (blow force) in sustain mode.

5.5 MANUAL MODE

For the user's convenience, the regulator offers the *Manual mode* module. In this function, each device (fan, CH pump, DHW pump, additional pump 1, additional contact and built-in valve) is switched on and off independently of the others.

Press **the pulser knob** to enable a given device. The device remains active until **the pulser knob** is pressed again.

Additionally, blow force function enables the user to set any speed of the fan in manual mode.

5.6 PUMP OPERATION MODES

This function enables the user to choose one of the following operation modes of the CH boiler.

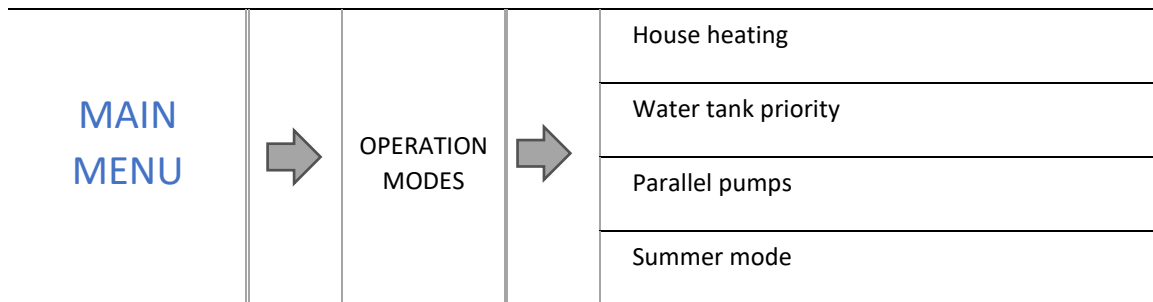

5.6.1 HOUSE HEATING

When this function is selected, only the house is heated. CH pump is activated when the temperature is above the CH pump activation threshold. Below this temperature value (minus hysteresis) the pump is disabled.

5.6.2 WATER TANK PRIORITY

In this mode, DHW pump operates until the pre-set water tank temperature is reached (the valves close to the maximum and the valve pumps are switched off). After the pre-set water tank temperature has been reached, the pump is disabled and the controller activates the CH pump and the mixing valves. When the water tank temperature drops below the pre-set value minus hysteresis, DHW pump is enabled again and the valves are disabled.



NOTE

If the water tank temperature is higher than the CH boiler temperature, the pump will not be activated in order not to cool down the water in DHW tank.

5.6.3 PARALLEL PUMPS

In this mode, the CH pump operates above the pump activation threshold. DHW pump is activated at the same time in order to heat the water tank. Once the pre-set DHW temperature has been reached, DHW pump is disabled. It is enabled again when the temperature drops by DHW hysteresis value.



NOTE

If current CH boiler temperature is lower than current water tank temperature, DHW pump will not be activated to prevent the water in the tank from cooling down.

5.6.4 SUMMER MODE

In this mode, only DHW pump is active (enabled when the DHW pump activation threshold is reached) and the CH valves are closed in order not to heat the house unnecessarily. If the CH boiler temperature is too high, the valve will open in an emergency procedure.

5.7 TIME SETTINGS

This option is used to set current time.

5.8 DATE SETTINGS

This option is used to set current date.

5.9 WEEKLY CONTROL

This function enables the user to program daily changes of the pre-set CH boiler temperature (*CH boiler weekly control* submenu) for particular time and day of the week.



NOTE

To ensure that this function works properly, it is necessary to set current time and date.

In order to activate the weekly control function, select *Mode 1* or *Mode 2*. Advanced settings of these modes are available further in the submenu: *Set mode 1* and *Set mode 2*.

Once a given mode has been selected, the main screen displays the value of current temperature deviation (below the pre-set CH temperature, alternately with *Pre-set*). It also indicates that the weekly control function is active.

How to change weekly control settings:

The EU-801 PID regulator offers two ways of configuring weekly control:

MODE 1 – the user sets the temperature deviations for each day of the week separately;

MODE 2 – the user sets the temperature deviations for all working days (Monday-Friday) and for the weekend (Saturday-Sunday) separately.

How to configure mode 1:

To program mode 1, select *Set mode 1* - the display shows a screen with individual days of the week.

After selecting the day of the week to be edited, the editing screen appears: the current deviation setting is displayed in the upper line, and the time period in the lower line. Turn the pulser knob to move to the next time period. To edit the setting, pre the pulser knob and select *Change*.

In order to copy the settings to the following hours, use the pulser knob and select *Copy*.

Example

Monday

pre-set: 3⁰⁰, temp -10⁰C (weekly control setting: -10⁰C)

pre-set: 4⁰⁰, temp -10⁰C (weekly control setting: -10⁰C)

pre-set: 5⁰⁰, temp -10⁰C (weekly control setting: -10⁰C)

If the pre-set CH boiler temperature is 60°C, on Mondays between 3⁰⁰ and 6⁰⁰ the CH boiler temperature will decrease by 10°C to reach 50°C.

How to configure mode 2:

In order to configure mode 2, select *Set mode 2* - the display will show a screen with two day groups: Monday - Friday and Saturday-Sunday. Select the group to be edited and follow the same steps as in mode 1

Example:

Monday-Friday

pre-set: 3⁰⁰, temp -10°C (weekly control setting: -10°C)

pre-set: 4⁰⁰, temp -10°C (weekly control setting: -10°C)

pre-set: 5⁰⁰, temp -10°C (weekly control setting: -10°C)

Saturday - Sunday

pre-set: 16⁰⁰, temp 5°C (weekly control setting: +5°C)

pre-set: 17⁰⁰, temp 5°C (weekly control setting: +5°C)

pre-set: 18⁰⁰, temp 5°C (weekly control setting +5°C)

In this case, if the pre-set CH boiler temperature is 60°C, then from 3⁰⁰ to 6⁰⁰ on each day of the week, from Monday to Friday, the pre-set boiler temperature will drop by 10°C to reach 50°C. During the weekend (Saturday, Sunday) from 16⁰⁰ to 19⁰⁰, the pre-set boiler temperature will increase by 5°C to reach 65°C.

5.10 FITTER'S MENU

Fitter's menu is intended to be accessed by a qualified person. It includes additional controller functions. Detailed parameters available in this menu are described in further part of this manual.

5.11 SERVICE MENU

In order to access service settings of the EU-801 PID controller, it is necessary to enter a 4-digit code provided by TECH.

5.12 LANGUAGE

This option is used to select the controller language version. It is also possible to change the language using the button with a flag.

5.13 FACTORY SETTINGS

The controller is pre-configured for operation. However, the settings should be customized to user's needs. Return to factory settings is possible at any time. When the factory settings option is activated, all customized settings of the CH boiler (saved in user's menu) are lost and replaced with factory settings. Then, the parameters may be customized anew.

5.14 SOFTWARE VERSION

This function enables the user to view the software version of the controller. Such information is necessary when contacting the service staff.

Fitter's menu is intended to be accessed by a qualified person. It includes additional controller functions such as CH boiler parameters, additional valves, additional pumps as well as advanced settings of basic functions (e.g. parameters of built-in valves).

FITTER'S MENU

Valve settings

Room regulator temperature lower

GSM module

Ethernet module

Room regulator

Operation algorithm

Buffer parameters

Pump activation temperature

DHW hysteresis

Additional heat source

Additional pump

Pulser knob sensitivity

External sensor calibration

Water tank disinfection

Pump anti-stop

Anti-freeze temperature

PID supervision**

CH boiler hysteresis*

Screen settings

Display contrast

Factory settings

* Option available only when PID function is disabled.

** Option available only when PID function is active.

6.1 VALVE SETTINGS

The EU-801 PID controller has a built-in module controlling the mixing valve. It is possible to connect two additional valve-controlling modules. There is a range of parameters allowing the user to adjust the valve operation to the individual needs. Once a valve has been enabled, the display shows an additional menu with valve parameters.

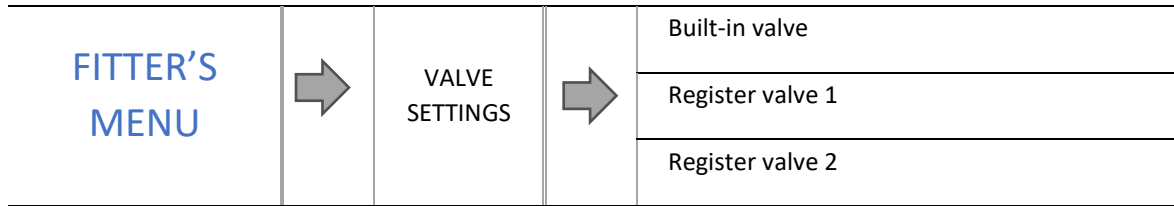

6.1.1 BUILT-IN VALVE, VALVE 1,2

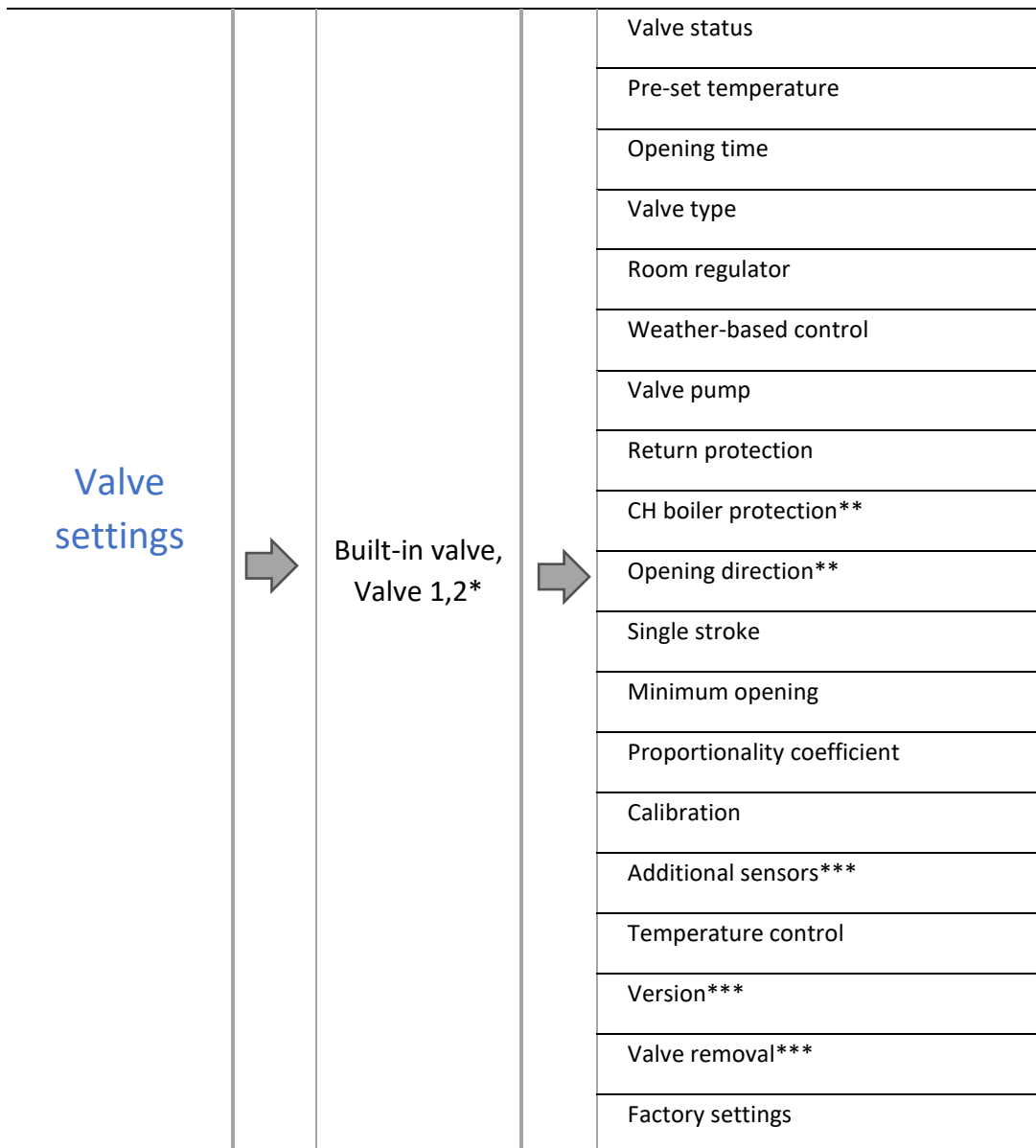

* Valve 1,2 menu is available only after the module has been registered

** Option available only for the built-in valve

*** Option available only for valve 1,2

6.1.1.1 VALVE STATUS

With this option the user may enable or disable the valve.

6.1.1.2 PRE-SET TEMPERATURE

This parameter defines the desired temperature which the valve should maintain. During proper operation, the temperature of water downstream of the valve approaches the pre-set value.

6.1.1.3 OPENING TIME

This parameter defines the time needed for the valve to open from 0% to 100% position. This value should be set in accordance with the specification given on the rating plate of the valve actuator.

6.1.1.4 VALVE TYPE

This option enables the user to choose the type of valve to be controlled:

- **CH** - select if you want to control the temperature of the CH circuit with the use of valve sensor. The valve sensor should be installed downstream of the mixing valve on the supply pipe.
 - **FLOOR** - select if you want to control the temperature of the underfloor heating circuit. It protects the underfloor heating system against dangerous temperature. If the user selects CH as the valve type and connects it to the underfloor heating system, the fragile floor installation may be damaged.
-

6.1.1.5 ROOM REGULATOR

This submenu is used to select and configure the parameters of the room regulator which is to control the valve.

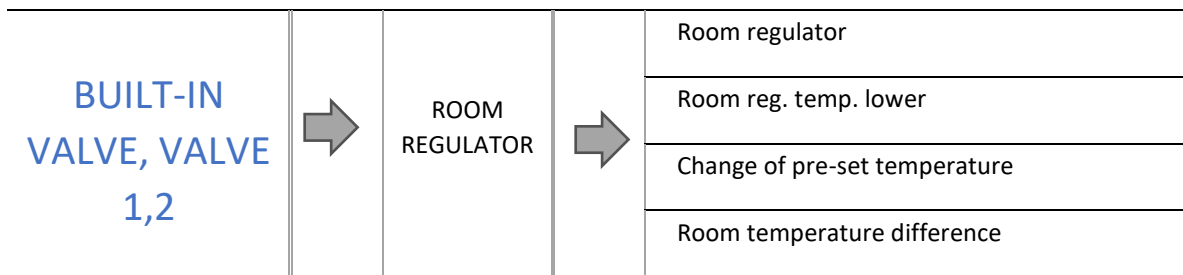

6.1.1.5.1 [Room regulator](#)

Control without room regulator– when this option is active, the room regulator does not influence the valve operation.

- **Control without room regulator**– when this option is active, the room regulator does not influence the valve operation.
- **Standard regulator** – this option should be selected if the valve will be controlled by a two-state room regulator (without RS communication).
- **TECH RS regulator** – select this option if you connect a room regulator with RS communication. Such a regulator enables the user to view current CH boiler parameters and change certain settings e.g. pre-set CH boiler temperature or pre-set DHW temperature.
- **RS proportional regulator** – activating this room regulator enables the user to monitor current temperature of CH boiler, water tank and the valves. The regulator should be connected to the RS port of the controller. When this type of room regulator is selected, the valve is controlled according to *Change of pre-set valve temp.* and *Room temperature difference* parameters.

6.1.1.5.2 [Room reg. temp. lower](#)



NOTE

This parameter concerns *Standard regulator* and *TECH RS regulator* functions.

The user defines the temperature value by which the pre-set CH boiler temperature will be reduced when the pre-set room regulator temperature is reached.

Temperature reduction will not be lower than the minimum pre-set CH temperature.

Example:

Pre-set CH boiler temperature	55°C
Room reg. temp. lower	15°C
Minimum pre-set CH boiler temperature	45°C
Pre-set CH boiler temperature after pre-set room temperature has been reached	45°C

Once the pre-set flat temperature has been reached (signalled by the room regulator), the pre-set CH boiler temperature will be reduced to 45°C, which is only by 10°C although the Room reg. temp. lower parameter is set to 15°C.

6.1.1.5.3 [Change of pre-set temperature](#)



NOTE

This parameter concerns the *RS proportional regulator* function.

This setting determines by how many degrees the valve temperature is to increase or decrease with a single unit change in room temperature (see: *Room temperature difference*) This function is active only with TECH room regulator and it is closely related to the *Room temperature difference* parameter.

Example:

SETTINGS:	
Room temperature difference	0,5°C
Change of pre-set valve temperature	1°C
Pre-set valve temperature	40°C
Pre-set temperature of room regulator	23°C

Case 1:

If the room temperature rises to 23,5°C (0,5°C above the pre-set room temperature), the valve closes until 39°C is reached (1°C change).

Case 2:

If the room temperature drops to 22°C (1°C below the pre-set room temperature), the valve opens until 42°C is reached (2°C change - because every 0,5°C of room temperature difference, the pre-set valve temperature changes by 1°C).

6.1.1.5.4 [Room temperature difference](#)



NOTE

This parameter concerns the *TECH proportional regulator* function.

This setting defines the single unit change in the current room temperature (with the accuracy of 0.1°C) at which a predefined change in the pre-set temperature of the valve will be introduced.

6.1.1.6 WEATHER-BASED CONTROL

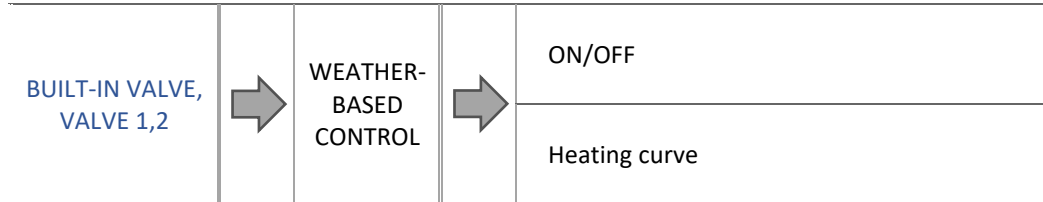

For the function of weather control to be active, the external sensor mustn't be exposed to sunlight or influenced by weather conditions. After it has been installed and connected, *weather-based control* function needs to be activated in the controller menu.

This setting is not available in the cooling mode or in the return protection mode.

6.1.1.6.1 Heating curve

Heating curve – a curve according to which the pre-set controller temperature is determined, on the basis of outside temperature. In order for the valve to operate properly, the user defines the pre-set temperature value (downstream of the valve) for respective values of outside temperatures -20°C, -10°C, 0°C and 10°C.

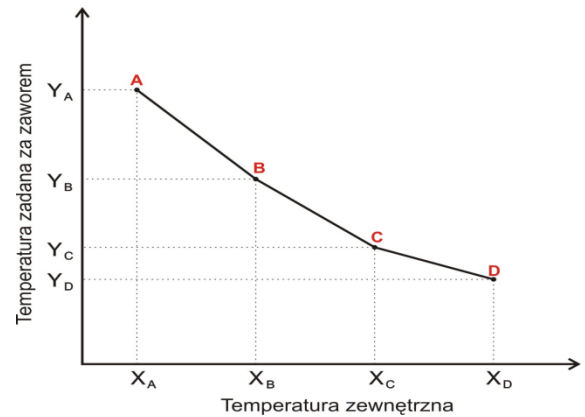

6.1.1.7 VALVE PUMP

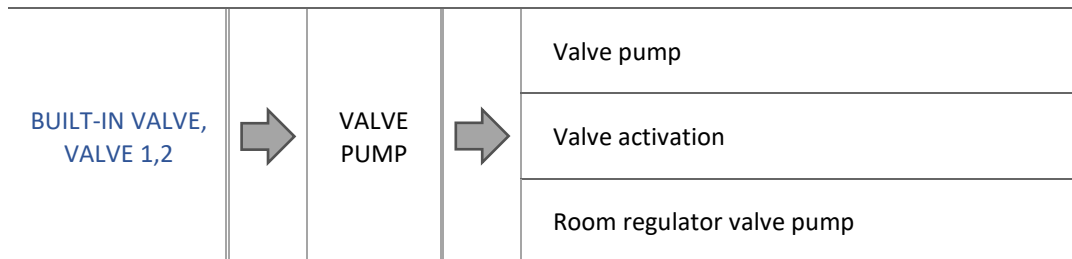

6.1.1.7.1 Valve pump

This option enables the user to select the pump operation mode:

- **Always ON** – the pump operates all the time, regardless of temperatures.
- **Always OFF** – the pump is switched off permanently and the regulator controls only the valve operation.
- **ON above threshold** – the pump is activated above the *switch-on temperature*. If the pump is to be activated above the threshold, the user should also define the threshold *pump switch-on temperature*. The controller uses the readings from CH temperature sensor.

6.1.1.7.2 Pump activation

This option concerns the pump activated above threshold. The valve pump will be activated when the CH boiler sensor reaches the pump switch-on temperature.

6.1.1.7.3 Room regulator valve pump

Once this function is selected, reaching pre-set room temperature in the room regulator results in deactivation of the valve pump.

6.1.1.8 RETURN PROTECTION

This function allows setting up CH boiler protection against too cool water returning from the main circulation, which could cause low-temperature boiler corrosion. The return protection involves closing the valve when the temperature is too low, until the short circulation of the boiler reaches the appropriate temperature.

6.1.1.9 CH BOILER PROTECTION

This option is available only for the built-in valve.

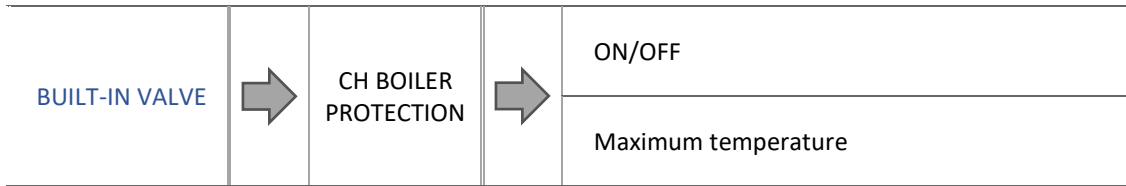

The protection against too high CH temperature serves to prevent hazardous increase in CH boiler temperature. The user sets the maximum acceptable CH boiler temperature. In the event of hazardous temperature increase, the valve begins to open to house heating system in order to cool down the CH boiler.

The CH boiler protection function is not available in *floor* mode.

6.1.1.9.1 [Maximum temperature](#)

The user defines the maximum acceptable CH temperature at which the valve will open.

6.1.1.10 OPENING DIRECTION

Option available only for built-in valve.

If it turns out after connecting the valve to the controller that it has been connected the wrong way round, the power supply cables do not have to be switched. Instead, it is enough to change the opening direction in this parameter: *Left* or *Right*.

6.1.1.11 SINGLE STROKE

This is a maximum single stroke (opening or closing) that the valve may make during one temperature sampling. If the temperature is close to the pre-set value, the stroke is calculated on the basis of the *proportionality coefficient* parameter value. The smaller the single stroke, the more precisely the set temperature can be achieved. However, it takes longer for the set temperature to be reached.

6.1.1.12 MINIMUM OPENING

The parameter determines the smallest valve opening. Thanks to this parameter, the valve may be opened minimally, to maintain the smallest flow.



NOTE

If the minimum opening is set to 0% (completely closed), the pump will not work when the valve is closed.

6.1.1.13 PROPORTIONALITY COEFFICIENT

Proportionality coefficient is used for defining *valve stroke*. The closer to the pre-set temperature, the smaller the stroke. If the coefficient value is high, the valve takes less time to open but at the same time the opening degree is less accurate.

The following formula is used to calculate the percent of a single opening:

$$\text{PERCENT OF SINGLE OPENING} = (\text{preset temp.} - \text{sensor temp.}) \cdot \frac{\text{proportionality coefficient}}{10}$$

6.1.1.14 CALIBRATION

This function enables the user to calibrate the built-in valve at any time. During this process, the valve is restored to its safe position – in the case of CH valve it is fully open whereas in the case of floor valve and cooling it is closed.

6.1.1.15 ADDITIONAL SENSORS

Option available for valves 1,2.

When two mixing valves are used, this function enables the user can select the sensors which will provide temperature data for the valve (for external and return temperature sensors). Temperatures can be read from the sensors of a given valve (own) or the sensors of valve 2 (from module 2).

6.1.1.16 TEMPERATURE CONTROL

This parameter defines the frequency of water temperature sampling (control) downstream of the CH or DHW valve. If the sensor detects temperature change (deviation from the pre-set value), the electric valve closes or opens appropriately (by the pre-set stroke) to restore the pre-set temperature.

6.1.1.17 VERSION

This function enables the user to check the software version of the subordinate module.

6.1.1.18 VALVE REMOVAL

Option available only for valve 1,2.

This option is used to remove the valve from the controller memory. *Valve removal* is used e.g. while disassembling the valve or replacing the module (re-registration of a new module is necessary).

6.1.1.19 FACTORY SETTINGS

When *factory settings* option is activated, all customized settings of the CH boiler (saved in user's menu) are lost and replaced with factory settings. Then, the parameters may be customized anew.

6.2 ROOM REG. TEMP. LOWER

The user defines the temperature value by which the pre-set CH temperature will be reduced when the pre-set room regulator temperature is reached.

6.3 GSM MODULE



NOTE

This type of control is available only after purchasing and connecting an additional controlling module ST-65 which is not included in the standard controller set.

If the controller is equipped with additional GSM module, it is necessary to activate it by selecting *ON*.

GSM Module is an optional device which, cooperating with the controller, enables the user remote control of the CH boiler operation via a mobile phone. The user is sent an SMS each time an alarm occurs. Moreover, after sending a certain text message, the user receives feedback on the current temperature of all the sensors. Remote change of the pre-set temperatures is also possible after entering the authorisation code.

GSM module may operate independently of the CH boiler controller. It has two additional inputs with temperature sensors, one contact input to be used in any configuration (detecting closing/opening of contacts) and one controlled output (e.g. a possibility of connecting an additional contractor to control any electric circuit).

When any of the temperature sensors reaches the pre-set maximum or minimum temperature, the module automatically sends an SMS with such information. A similar procedure is used in the case of opening or closing of the contact input, which may be used as a simple means of property protection.

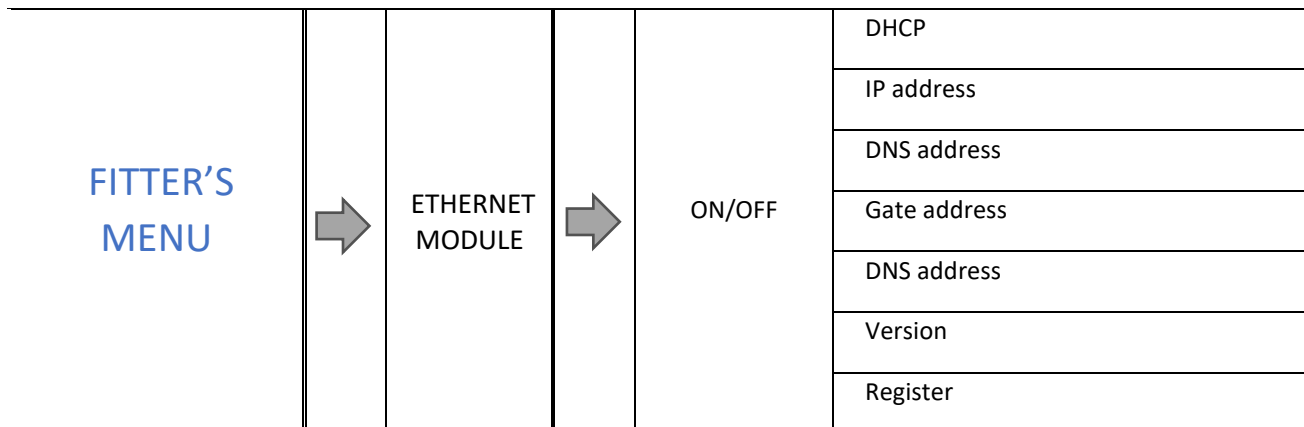

- ⇒ Before registering the module, it is necessary to create user's account on emodul.pl (if you do not have one).
- ⇒ Once the module has been connected properly, select *Module ON*.

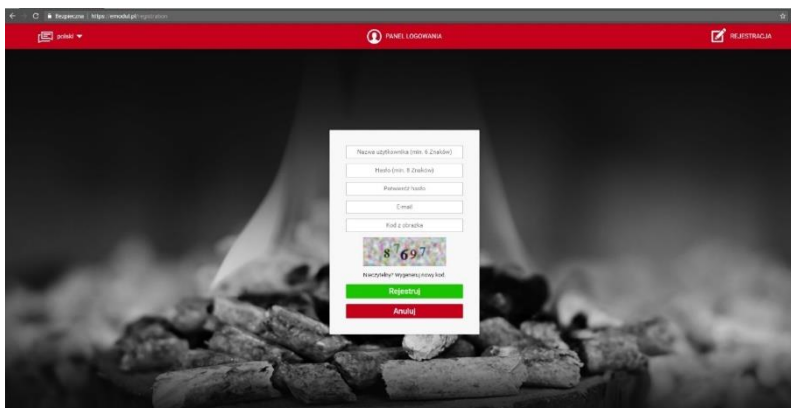

- ⇒ Next, select *Registration*. The controller will generate a code.
- ⇒ Log on emodul.pl, go to *Settings* tab and enter the code which appeared on the controller screen.
- ⇒ It is possible to assign a name or description to the module as well as provide phone number and e-mail address to which the notifications will be sent.
- ⇒ Once generated, the code should be entered within 60 minutes. Otherwise, it will become invalid and it will be necessary to generate a new one.

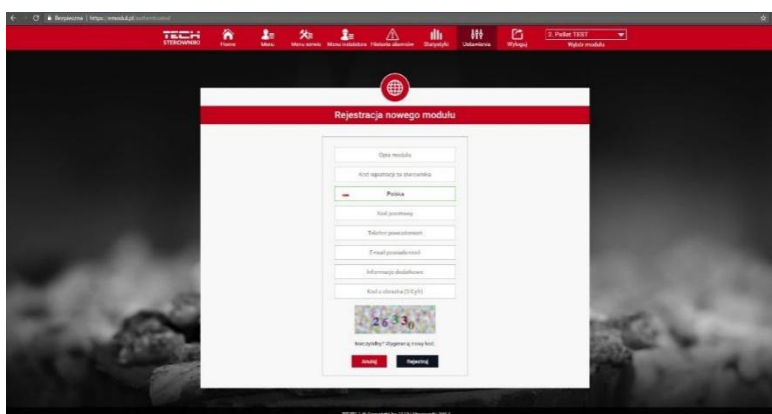

- ⇒ Internet module parameters such as IP address, IP mask, gate address etc. may be set manually or by selecting DHCP option.

Internet module is a device enabling the user remote control of the CH boiler via the Internet. [Emodul.pl](http://emodul.pl) enables the user to control the status of all CH boiler system devices and temperature sensors on the home computer screen, tablet or smart phone. Tapping on corresponding icons, the user may adjust the operation parameters and pre-set temperatures for pumps and valves etc.



6.5 ROOM REGULATOR

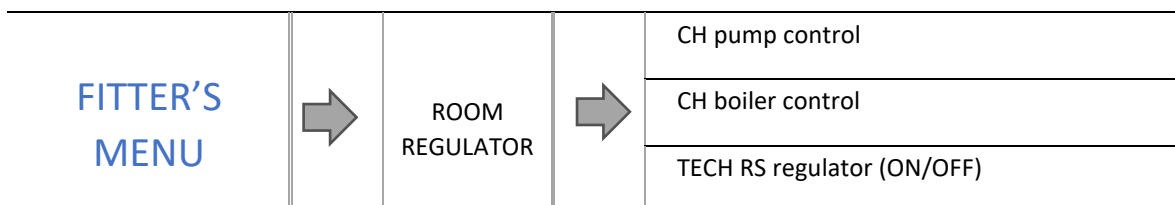

This function enables the user to select the type of regulator connected to the EU-801 PID controller and configure the room regulator operation.

6.5.1 CH PUMP CONTROL

This function enables the room regulator to influence the operation of the CH pump. When this function is active, the CH pump will be disabled when the room regulator reports that the pre-set room temperature has been reached.

- **Standard regulator** – select this option if the valve will be controlled by a two-state room regulator (without RS communication).
- **TECH RS regulator** – select this option if you connect a room regulator with RS communication. Such a regulator enables the user to view current CH boiler parameters and change certain settings e.g. pre-set CH boiler temperature or pre-set DHW temperature.

6.5.2 CH BOILER CONTROL

When the room regulator reports that the pre-set room temperature has been reached, it will decrease the pre-set CH boiler temperature by the value of the *Room reg. temp. lower* parameter found in the Fitter's menu.

- **Standard regulator** – select this option if the valve will be controlled by a two-state room regulator (without RS communication).
- **TECH RS regulator** – select this option if you connect a room regulator with RS communication. Such a regulator enables the user to view current CH boiler parameters and change certain settings e.g. pre-set CH boiler temperature or pre-set DHW temperature.

6.6 OPERATION ALGORITHM

6.6.1 STANDARD

When *Standard* operation mode has been selected, the controller works as an ordinary two-state controller, and an additional option will appear in the main menu - *Operation settings*.

A detailed description of the *Operation settings* parameters can be found in section 5.4.

The fan operation depends on the user's settings and the current temperature of the CH boiler. If the current temperature is much lower than the pre-set temperature (e.g. after the fire-up phase is over), the fan operates according to user-defined settings.

6.6.2 PID

The EU-801 PID is a controller with continuous output signal, using **PID control algorithm**. This type of controller calculates the fan speed on the basis of CH boiler temperature and the flue gas temperature measured at the CH boiler outlet. The fan operates continuously and the fan blow force depends on the CH boiler temperature, the flue gas temperature as well as the difference between these parameters and their pre-set values. One of the greatest advantages of PID regulators is their ability to maintain a stable pre-set temperature without unnecessary overregulation and oscillations.

Apart from PID control, the controller operation is adjusted on the basis of the the readings from the air flow sensor mounted on the fan.

Using this type of regulator with a flue gas sensor helps to reduce fuel costs by up to several percent. Moreover, it ensures stable temperature of output water thus prolonging the life of the heat exchanger (of the CH boiler). Flue gas temperature control results in low emission of dust and environmentally harmful gases. Flue gas heat is not disposed of through the chimney, but it is utilised for heating purposes.

TEST RESULTS - TECH controller with PID control:

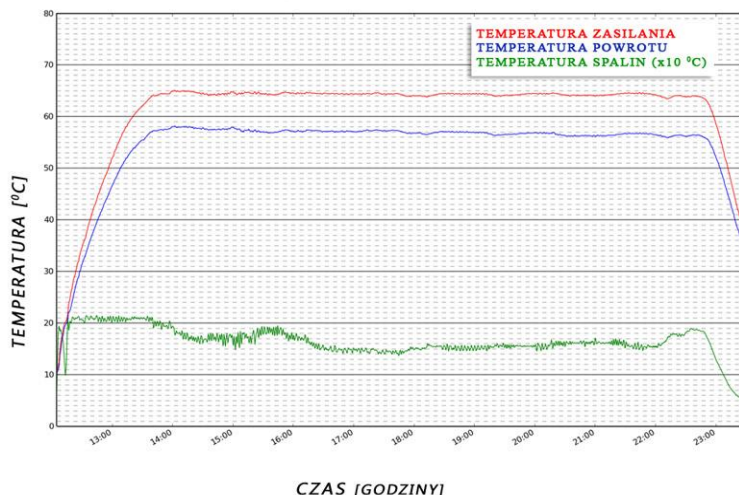

TEST RESULTS - TECH controller without PID control:

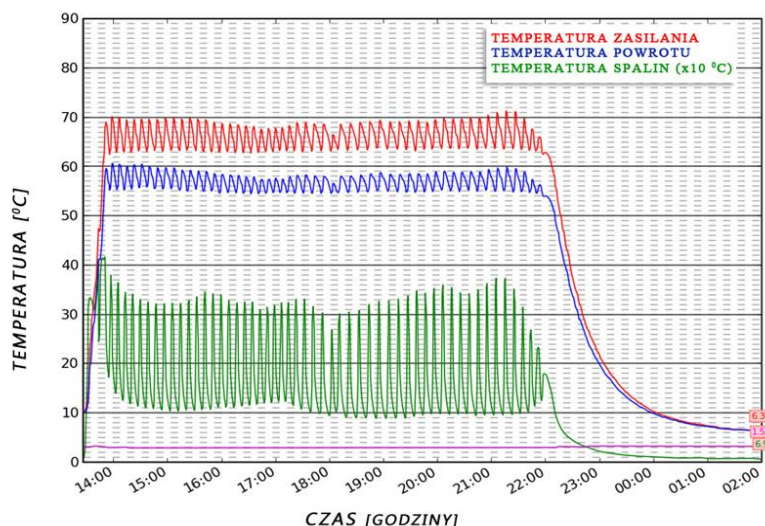

All remarks concerning the software should be reported to the CH boiler manufacturer. Each controller should be customized to individual needs, depending on the type of fuel and CH boiler used. TECH does not accept responsibility for incorrect configuration of the controller settings.

6.7 BUFFER PARAMETERS

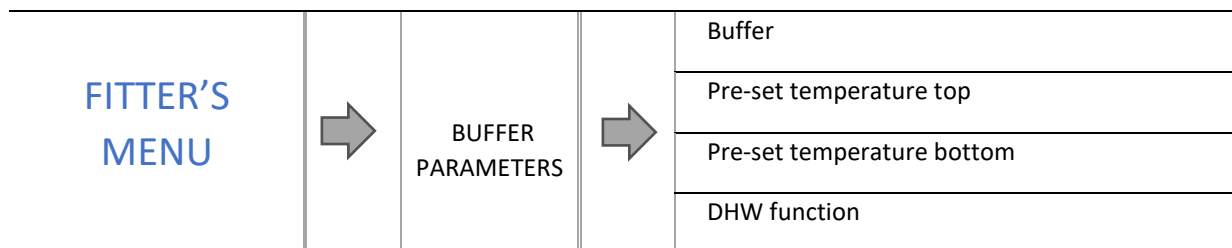

These parameters enable the user to configure controller operation settings in the case of heating systems with a buffer.

6.7.1 BUFFER

Once the buffer function has been activated (by selecting ON), the CH pump serves as pump of the buffer in which two sensors are installed: upper sensor (C1) and lower sensor (C2). The pump remains active until the pre-set parameters are reached. When the temperature drops below the pre-set buffer top temperature, the pump is activated again. When the buffer is enabled, activating fire-up function results in buffer temperature adjustment.

Selecting *ON* will result in changing the CH sensor for the valve - additional sensor 1 will serve this function.

6.7.2 PRE-SET TEMPERATURE TOP

This function enables the user to define the pre-set temperature for the upper part of the buffer (C1 sensor should be placed in the upper part of the tank).

6.7.3 PRE-SET TEMPERATURE BOTTOM

This function enables the user to define the pre-set temperature for the lower part of the buffer (the sensor should be placed in the lower part of the tank).

6.7.4 DHW FUNCTION

In the case of a heating systems with a buffer, it is necessary to select the type of DHW tank connection

-from buffer – select if DHW tank is built in the buffer or directly connected to it. If this option has been selected, DHW pump works according to the readings from the buffer sensor.

-from CH boiler – select if DHW tank is connected directly to the CH boiler (another circulation which is separate from the buffer). If this option has been selected, DHW pump works according to the readings from the CH sensor.

6.8 PUMP ACTIVATION TEMPERATURE

This option is used to define the temperature at which the pumps are activated (temperature measured at the CH boiler). Below this temperature value the pumps remain inactive whereas above this value the pumps are enabled and operate according to the selected operation mode.

6.9 DHW HYSTERESIS

This option is used to set the hysteresis of the pre-set water tank temperature. It is the difference between the pre-set temperature (desired temperature of water in the water tank) and the temperature of returning to operation mode.

:

Pre-set DHW temperature	55°C
Hysteresis	5°C
Pump deactivation	55°C
Pump activation	50°C

When the pre-set temperature is 55°C, the hysteresis is 5°C, the device is switched off at the temperature of 55 °C and returning to operation mode takes place when the temperature drops to 50 °C.

6.10 ADDITIONAL HEAT SOURCE

This option is available only in *Standard* operation mode. Using this option the user may enable or disable the additional heat source.

6.11 ADDITIONAL PUMP

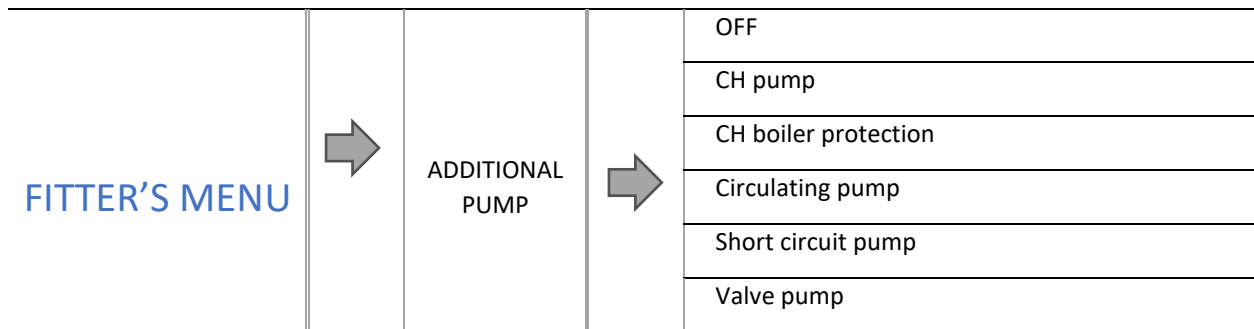

The user may connect an additional pump. Next, depending on the type of pump, it needs to be configured properly.

6.11.1 CH PUMP

Once this option has been selected, the additional pump serves as the CH pump. The pump is activated when the sensor temperature exceeds the temperature threshold.

The following parameters need to be configured for this function to work correctly:

6.11.1.1 ACTIVATION TEMPERATURE

This parameter defines the activation time of the additional pump which serves as the CH pump. When the selected sensor reaches this temperature, the pump is activated.

6.11.1.2 HYSTERESIS

This parameter defines the hysteresis of the additional CH pump threshold temperature. It is the difference between the threshold temperature and the temperature of deactivation.

Example:

When the threshold temperature is 40°C and hysteresis is 5°C. When the threshold temperature is reached, CH pump is activated. It is switched off when the temperature drops to 35°C).

6.11.1.3 SENSOR SELECTION

It allows the user to decide which sensor should provide data for activation of the additional CH pump: CH sensor, DHW sensor, valve 1 sensor, return sensor, weather sensor, buffer sensor top, buffer sensor bottom.

6.11.1.4 ROOM REGULATOR

This function enables the user to choose the regulator (TECH regulator or Standard regulator) which will send a signal when the pre-set room temperature is reached (the pump will be disabled).

6.11.2 CH BOILER PROTECTION

When this option has been selected, the additional device will function as a boiler protection pump - preventing too low water temperature on the boiler return. This pump will be activated after the boiler reaches appropriate temperature and it will operate until a sufficient return temperature is reached. The following operation parameters need to be configured:

6.11.2.1 ACTIVATION TEMPERATURE

This parameter defines the temperature of return pump activation. The temperature is read from sensor 1 (CH boiler temperature).

6.11.2.2 MAXIMUM TEMPERATURE

This parameter define the temperature at which the pump will be disabled.

6.11.2.3 SENSOR SELECTION

It allows the user to decide which sensor should provide data for activation of the additional pump: CH sensor, DHW sensor, valve 1 sensor, return sensor, weather sensor, buffer sensor top, buffer sensor bottom.

6.11.3 CIRCULATING PUMP

When this function is active, the additional pump serves as the circulating pump. The pump controls the valve which mixes the hot water between the CH boiler and the DHW receivers. The following parameters need to be configured for the circulating pump to work correctly:

6.11.3.1 OPERATION TIME

This parameter is used to define the operation time of the pump.

6.11.3.2 PAUSE TIME

This parameter defines the frequency at which the circulating pump is enabled during its activity. It is the period time when the pump remains inactive.

6.11.3.3 OPERATION SCHEDULE

The user may program a daily schedule of pump operation and inactivity.

6.11.4 SHORT CIRCUIT PUMP

This option enables the user to select the operation mode of the pump. The pump will be activated above the threshold (the pump will switch on above the pre-set activation temperature). If the pump is to be activated above the threshold, the temperature of the pump activation threshold should also be set (temperature measured by the CH sensor).

6.11.5 VALVE PUMP

When this option has been selected, the additional device will serve as a valve pump. Its task is to mix hot water between the CH boiler and the heating circuit.

6.12 PULSER KNOB SENSITIVITY

This function is used to adjust the sensitivity of the pulser knob within the range of 1-3 (1 is the highest sensitivity).

6.13 EXTERNAL SENSOR CALIBRATION

External sensor correction should be performed during installation or after a longer period of using the regulator when the temperature measured by the sensor is different from actual temperature. Range of regulation is -5°C to +5 °C with the accuracy of 0,1°C.

6.14 WATER TANK DISINFECTION

Thermal disinfection involves raising the temperature of water in the DHW circuit to the minimum of 60 °C (required disinfection temperature). Current regulations require adjusting the DHW installation to enable thermal disinfection carried out in the temperature of at least 60°C (recommended temperature: 70°C). Piping, fittings and technological design of the DHW system need to meet this requirement.

DHW disinfection aims to eradicate *Legionella pneumophila* – bacteria which lower the cell-mediated immunity. The bacteria often multiplies in hot water reservoirs (optimum temperature: 35°C), which often happens in water tanks.

After this function is activated (it is possible only in *Water tank priority* mode), the water tank is heated until the pre-set temperature of 70°C is reached (default setting). The temperature is maintained for the whole disinfection time (default setting: 10 minutes). Next, the standard operation mode is restored.

Disinfection temperature needs to be reached within 60 minutes from its activation (default setting) Otherwise, the function will be automatically deactivated.

6.15 PUMP ANTI-STOP

When this function is active, the pump is activated at a user-defined frequency (every 1-20 days), for a pre-defined time (minimum: 30 seconds; maximum: 180 seconds). It prevents stagnant water in the heating system outside the heating season.

6.16 ANTI-FREEZE TEMPERATURE

This function is used to configure anti-freeze option which serves as protection of the heating system against freezing. When the CH boiler sensor temperature or water tank sensor temperature drops below the pre-set temperature threshold, the pump is enabled permanently. It will be disabled when the circuit temperature rises.

6.17 PID SUPERVISION**

This mode will be activated automatically if the temperature exceeds the pre-set value by more than 5°C in operation mode. In such a case, the controller disables PID control and uses manual settings (according to the parameters defined in the *fitter's menu*) in order to reduce the temperature of the circulating water. The screen displays notification: *PID: SUPERVISION*.

6.18 CH BOILER HYSTERESIS*

When PID function is disabled, CH boiler hysteresis option appears in the fitter's menu.

This option is used to set the hysteresis of the pre-set CH temperature. It is the difference between the temperature of entering the sustain mode and the temperature of restoring operation mode. (e.g. when the pre-set temperature is 60°C, the hysteresis is 3°C, entering sustain mode takes place at the temperature of 60°C whereas returning to the operation mode takes place when the temperature drops to 57 °C.

6.19 SCREEN SETTINGS

This option enables the user to configure such screen parameters as screen brightness, screen blanking and screen blanking time.

6.20 DISPLAY CONTRAST

This function enables the user to adjust the display contrast.

6.21 FACTORY SETTINGS

The controller is pre-configured for operation. However, the settings should be customized to user's needs. Return to factory settings is possible at any time. When the factory settings option is activated, all customized settings of the CH boiler (saved in user's menu) are lost and replaced with factory settings. Then, the parameters may be customized anew.

7 PROTECTIONS

In order to ensure safe and failure-free operation, the regulator has been equipped with a range of safeguards. In case of alarm, a sound signal is activated and the display shows an appropriate message.

In order for the controller to return to the operation mode, press **pulser knob**. In the case of **CH temperature too high** alarm, it is necessary to wait until the temperature drops below the alarm value.

7.1 TEMPERATURE ALARM

This protection is activated only in **operation** mode (when the CH boiler temperature is lower than the *pre-set temperature* value). If the CH boiler temperature does not increase within the period of time defined by the user, an alarm is activated: the fan is disabled and a sound signal is activated. The display shows the following message: **Temperature not rising**. Press the **pulser knob** to deactivate the alarm. The controller will resume the previously selected operation mode.

7.2 THERMAL PROTECTION

The controller is equipped with a bimetallic mini-sensor (installed near the CH boiler temperature sensor or on the supply pipe, as near the CH boiler as possible), which automatically disconnects the fan when the alarm temperature of 85±90°C is exceeded. It prevents the water in the system from boiling in case of CH boiler overheating or controller damage. After this protection has been activated and the temperature has dropped to a safe level, the sensor automatically unlocks itself. When the sensor is damaged or overheated, the fan is disabled.



NOTE

When this sensor is damaged, the fan is disabled in both manual and automatic mode.

7.3 AUTOMATIC SENSOR CONTROL

If one of the temperature sensors (CH, DHW, screw feeder or fuel tank) is damaged, an alarm sound is activated and the display informs about the failure; e.g. **CH sensor damaged. The fan is disabled. The pump operates regardless of current temperature.**

*If the CH sensor is damaged, the alarm is active until a new sensor is installed. In the case of DHW sensor damage, the alarm should be switched off by pressing **pulser knob** – the controller will restore operation with one pump (CH). A new sensor should be installed so that all modes of CH boiler operation could be available.*

7.4 PROTECTION AGAINST BOILING OF WATER IN THE CH BOILER

This protection applies only to water tank priority mode, in the case when the water tank is insufficiently heated. When the pre-set temperature of the water boiler is 55°C whereas the actual CH boiler temperature reaches 62°C (so called *priority temperature*), the controller disables the fan. If the CH boiler temperature still increases reaching 80°C, the CH pump will be switched on. In the case of further temperature increase, an alarm will be activated at the temperature of 85°C. Such a situation usually occurs when the water tank or the pump is damaged or when the sensor is incorrectly mounted. When the temperature drops, at 60°C the controller enables the fan and it remains in operation mode until the temperature of 62°C is reached.

7.5 TEMPERATURE PROTECTION

The regulator has an additional protection against hazardous temperature growth. If the alarm temperature of 80°C is exceeded, the fan is disabled and the pumps are switched on in order to distribute hot water throughout the house installation. When the temperature of 85°C is exceeded, an alarm is activated and the display shows the following alarm message: **Temperature too high**. When the temperature drops to a safe level, press the **pulser knob** to deactivate the alarm and return to the previous operation mode.

7.6 FUSE

The regulator has a WT 3,15A tube fuse-link protecting the network.



NOTE:

Higher amperage fuse should not be used as it may damage the controller.

8 TECHNICAL DATA

Before and during the heating season, the **EU-801 PID** controller should be checked for condition of its cables. The user should also check if the controller is properly mounted and clean it if dusty or dirty. It is advisable to measure earthing parameters for the motors (CH pump, DHW pump and fan).

No.	Specification	
1	Power supply	230V \pm 10% /50Hz
2	Max. power consumption	11 W
3	Ambient working temperature	5 \div 50°C
4	Pump max. output load	0,5A
5	Mixing valve max. output load	0,5A
6	Fan max. output load	0,6A
7	KTY sensor thermal resistance	-30 \div 99°C
8	Flue gas sensor thermal resistance	-30 \div 480°C
9	Fuse	3,15A

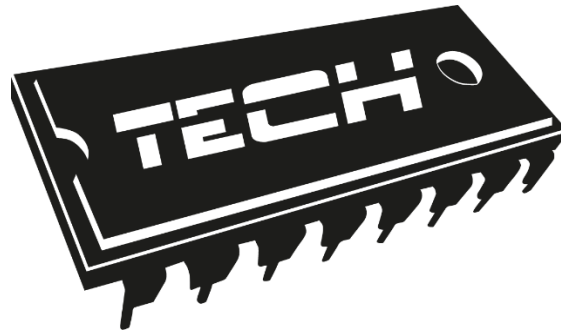

EU DECLARATION OF CONFORMITY

Hereby, we declare under our sole responsibility that **EU-801 PID** manufactured by TECH, head-quartered in Wieprz Biała Droga 31, 34-122 Wieprz, is compliant with Directive **2014/35/EU** of the European Parliament and of the Council of 26 February 2014 on the harmonisation of the laws of Member States relating to **the making available on the market of electrical equipment designed for use within certain voltage limits** (EU OJ L 96, of 29.03.2014, p. 357), **Directive 2014/30/EU** of the European Parliament and of the Council of 26 February 2014 on the harmonisation of the laws of Member States relating to **electromagnetic compatibility** (EU OJ L 96 of 29.03.2014, p.79), Directive **2009/125/EC** establishing a framework for the setting of ecodesign requirements for energy-related products as well as the regulation by the MINISTRY OF ENTREPRENEURSHIP AND TECHNOLOGY of 24 June 2019 amending the regulation concerning the essential requirements as regards the restriction of the use of certain hazardous substances in electrical and electronic equipment, implementing provisions of Directive (EU) 2017/2102 of the European Parliament and of the Council of 15 November 2017 amending Directive 2011/65/EU on the restriction of the use of certain hazardous substances in electrical and electronic equipment (OJ L 305, 21.11.2017, p. 8).

For compliance assessment, harmonized standards were used:

PN-EN IEC 60730-2-9:2019-06, PN-EN 60730-1:2016-10.

PAWEŁ JURA

JANUSZ MASTER

WŁAŚCICIELE TECH SPÓŁKA Z OGRANICZONĄ ODPOWIEDZIALNOŚCIĄ SP. K.

Wieprz, **18.08.2021**

TECH STEROWNIKI

Spółka z ograniczoną odpowiedzialnością Sp. k.

*Biała Droga 31
34-122 Wieprz*

SERWIS

**32-652 Bulowice,
Skotnica 120**

**Tel. +48 33 8759380, +48 33 3300018
+48 33 8751920, +48 33 8704700
Fax. +48 33 8454547**

serwis@techsterowniki.pl

Monday - Friday

7:00 - 16:00

Saturday

9:00 - 12:00